



National Défense
Defence nationale

A-CR-CCP-801/PF-001



ROYAL CANADIAN AIR CADETS

PROFICIENCY LEVEL ONE – INSTRUCTIONAL GUIDES

(ENGLISH)

Cette publication est disponible en français sous le numéro A-CR-CCP-801/PF-002.

Issued on Authority of the Chief of the Defence Staff

Canada



ROYAL CANADIAN AIR CADETS

PROFICIENCY LEVEL ONE – INSTRUCTIONAL GUIDES

(ENGLISH)

Cette publication est disponible en français sous le numéro A-CR-CCP-801/PF-002.

Issued on Authority of the Chief of the Defence Staff

OPI: D Cdts 3 – Senior Staff Officer Youth Programs Development

2007-01-01

Canada¹¹

LIST OF EFFECTIVE PAGES

Insert latest changed pages and dispose of superseded pages in accordance with applicable orders.

NOTE

The portion of the affected by the latest change is indicated by a black vertical line in the margin of the page. Changes to illustrations are indicated by miniature pointing hands or black vertical lines.

Dates of issue for original and changed pages are:

Original.....	0	2007-01-01	Ch.....	3
Ch.....	1		Ch.....	4
Ch.....	2		Ch.....	5

Zero in Change No. column indicates an original page. Total number of pages in this publication is 873 consisting of the following:

Page No.	Change No.	Page No.	Change No.
Cover page.....	0	5-2-1 to 5-2-10.....	0
Title.....	0	5-3-1 to 5-3-10.....	0
A to C.....	0	5-4-1 to 5-4-18.....	0
i to xvi.....	0	5A-1 to 5A-2.....	0
1-1-1 to 1-1-12.....	0	5B-1 to 5B-28.....	0
1-2-1 to 1-2-6.....	0	5C-1 to 5C-8.....	0
1A-1 to 1A-2.....	0	5D-1 to 5D-4.....	0
2-1-1 to 2-1-6.....	0	5E-1 to 5E-2.....	0
2-2-1 to 2-2-6.....	0	5F-1 to 5F-6.....	0
2-3-1 to 2-3-4.....	0	5G-1 to 5G-2.....	0
3-1-1 to 3-1-6.....	0	5H-1 to 5H-8.....	0
3-2-1 to 3-2-6.....	0	6-1-1 to 6-1-6.....	0
3-3-1 to 3-3-6.....	0	6-2-1 to 6-2-8.....	0
3-4-1 to 3-4-6.....	0	6-3-1 to 6-3-10.....	0
3-5-1 to 3-5-4.....	0	6-4-1 to 6-4-6.....	0
3-6-1 to 3-6-6.....	0	6-5-1 to 6-5-4.....	0
3A-1 to 3A-2.....	0	6-6-1 to 6-6-4.....	0
3B-1 to 3B-2.....	0	6-7-1 to 6-7-4.....	0
3C-1 to 3C-2.....	0	6A-1 to 6A-2.....	0
3D-1 to 3D-2.....	0	6B-1 to 6B-2.....	0
3E-1 to 3E-10.....	0	7-1-1 to 7-1-6.....	0
4-1-1 to 4-1-4.....	0	7-2-1 to 7-2-10.....	0
4-2-1 to 4-2-4.....	0	7-3-1 to 7-3-8.....	0
4-3-1 to 4-3-4.....	0	7-4-1 to 7-4-8.....	0
4-4-1 to 4-4-4.....	0	7-5-1 to 7-5-14.....	0
4A-1 to 4A-2.....	0	7-6-1 to 7-6-6.....	0
5-1-1 to 5-1-10.....	0	7-7-1 to 7-7-8.....	0

LIST OF EFFECTIVE PAGES (Cont)

Page No.	Change No.	Page No.	Change No.
7-8-1 to 7-8-6.....	0	8E4-1 to 8E4-2.....	0
7-9-1 to 7-9-6.....	0	8E5-1 to 8E5-2.....	0
7-10-1 to 7-10-6.....	0	9-1-1 to 9-1-8.....	0
7A-1 to 7A-2.....	0	9-2-1 to 9-2-6.....	0
7B-1 to 7B-2.....	0	9-3-1 to 9-3-6.....	0
7C-1 to 7C-4.....	0	9A-1 to 9A-4.....	0
7D-1 to 7D-2.....	0	10-1 to 10-6.....	0
7E-1 to 7E-2.....	0	10-A-1 to 10-A-2.....	0
7F-1 to 7F-2.....	0	10-B-1 to 10-B-2.....	0
7G-1 to 7G-2.....	0	11-1 to 11-6.....	0
7H-1 to 7H-2.....	0	12-1-1 to 12-1-10.....	0
8-1-1 to 8-1-8.....	0	12-2-1 to 12-2-8.....	0
8-2-1 to 8-2-6.....	0	12-3-1 to 12-3-10.....	0
8-3-1 to 8-3-8.....	0	12-4-1 to 12-4-6.....	0
8-4-1 to 8-4-6.....	0	12-5-1 to 12-5-6.....	0
8-5-1 to 8-5-6.....	0	12-6-1 to 12-6-14.....	0
8-6-1 to 8-6-6.....	0	12A-1 to 12A-38.....	0
8-7-1 to 8-7-6.....	0	12B-1 to 12B-16.....	0
8-8-1 to 8-8-6.....	0	12C-1 to 12C-2.....	0
8-9-1 to 8-9-6.....	0	12D-1 to 12D-2.....	0
8-10-1 to 8-10-6.....	0	12E-1 to 12E-2.....	0
8-11-1 to 8-11-6.....	0	12F-1 to 12F-2.....	0
8-12-1 to 8-12-4.....	0	12G-1 to 12G-2.....	0
8-13-1 to 8-13-2.....	0	12H-1 to 12H-2.....	0
8-14-1 to 8-14-4.....	0	12I-1 to 12I-8.....	0
8A-1 to 8A-2.....	0	13-1-1 to 13-1-6.....	0
8A1-1 to 8A1-2.....	0	13-2-1 to 13-2-8.....	0
8A2-1 to 8A2-2.....	0	13A-1 to 13A-2.....	0
8B-1 to 8B-2.....	0	13B-1 to 13B-2.....	0
8B1-1 to 8B1-4.....	0	13C-1 to 13C-6.....	0
8B2-1 to 8B2-2.....	0	13D-1 to 13D-6.....	0
8C-1 to 8C-2.....	0	13E-1 to 13E-6.....	0
8C1-1 to 8C1-4.....	0	13F-1 to 13F-4.....	0
8C2-1 to 8C2-2.....	0	13G-1 to 13G-2.....	0
8D-1 to 8D-10.....	0	14-1-1 to 14-1-6.....	0
8D1-1 to 8D1-4.....	0	14-2-1 to 14-2-6.....	0
8D2-1 to 8D2-2.....	0	14-3-1 to 14-3-8.....	0
8D3-1 to 8D3-2.....	0	14-A-1 to 14A-8.....	0
8E-1 to 8E-4.....	0	15-1-1 to 15-1-8.....	0
8E1-1 to 8E1-2.....	0	15-2-1 to 15-2-6.....	0
8E2-1 to 8E2-2.....	0	15-3-1 to 15-3-10.....	0
8E3-1 to 8E3-2.....	0	15-4-1 to 15-4-8.....	0

LIST OF EFFECTIVE PAGES (Cont)

Page No.	Change No.	Page No.	Change No.
15-5-1 to 15-5-8.....	0	15-12-1 to 15-12-10.....	0
15-6-1 to 15-6-10.....	0	15A-1 to 15A-2.....	0
15-7-1 to 15-7-12.....	0	15B-1 to 15B-2.....	0
15-8-1 to 15-8-10.....	0	15C-1 to 15C-8.....	0
15-9-1 to 15-9-14.....	0	15D-1 to 15D-2.....	0
15-10-1 to 15-10-6.....	0	15E-1 to 15E-2.....	0
15-11-1 to 15-11-6.....	0		

Contact Officer: D Cds 3-2-6 – Air Cadet Program Development Staff Officer

© 2007 DND/MDN Canada

FOREWORD AND PREFACE

1. **Issuing Authority.** This Instructional Guide (IG) A-CR-CCP-801/PF-001 was developed under the authority of the Director Cadets in accordance with CATO 11-03, *Cadet Program Mandate*, CATO 11-04, *Cadet Program Outline*, and CATO 51-01, *Air Cadet Program Outline*, and issued on the authority of the Chief of Defence Staff.
2. **Development.** Development of this IG was in accordance with the performance oriented concept of training outlined in the A-P9-050 Series, Canadian Forces Individual Training and Education System, with modifications to meet the needs of the Cadet Organization.
3. **Purpose of the IG.** The IG is to be used by Royal Canadian Air Cadet Squadrons to conduct the Proficiency Level One Training Program, as outlined in CATO 11-04, *Cadet Program Outline*, and CATO 51-01, *Air Cadet Program Outline*.
4. **Effective Date.** This publication is effective upon receipt. Subsequent changes are effective upon receipt.
5. **Suggested Changes.** Suggested changes to this document shall be forwarded through the normal chain of command to National Defence Headquarters (NDHQ) Attention: Air Cadet Program Development Staff Officer (D Cdts 3-2-6), or by email to air.dev@cadets.net.

THIS PAGE INTENTIONALLY LEFT BLANK

TABLE OF CONTENTS

		PAGE
CHAPTER 1	PO 101 – PARTICIPATE IN CITIZENSHIP ACTIVITIES	
Section 1	EO M101.01 – PARTICIPATE IN A DISCUSSION ON CANADIAN SYMBOLS....	1-1-1
Section 2	EO C101.02 – WATCH <i>HISTORICA MINUTES</i> VIDEOS.....	1-2-1
Annex A	THE CANADIAN COAT OF ARMS.....	1A-1
CHAPTER 2	PO 102 – PERFORM COMMUNITY SERVICE	
Section 1	EO M102.01 – PERFORM COMMUNITY SERVICE.....	2-1-1
Section 2	EO C102.01 – PARTICIPATE IN A CEREMONIAL PARADE.....	2-2-1
Section 3	EO C102.02 – PERFORM COMMUNITY SERVICE.....	2-3-1
CHAPTER 3	PO 103 – PARTICIPATE AS A MEMBER OF A TEAM	
Section 1	EO M103.01 – IDENTIFY THE RESPONSIBILITIES OF A FOLLOWER IN A TEAM.....	3-1-1
Section 2	EO M103.02 – MAP PERSONAL GOALS FOR THE TRAINING YEAR.....	3-2-1
Section 3	EO M103.03 – PARTICIPATE IN TEAM BUILDING ACTIVITIES.....	3-3-1
Section 4	EO C103.01 – PARTICIPATE IN ICEBREAKER ACTIVITIES.....	3-4-1
Section 5	EO C103.02 – PARTICIPATE IN SELF-INTRODUCTIONS.....	3-5-1
Section 6	EO C103.03 – PARTICIPATE IN TEAM BUILDING ACTIVITIES.....	3-6-1
Annex A	WORD GAME.....	3A-1
Annex B	SELF-ESTEEM SCALE.....	3B-1
Annex C	GOAL MAPPING EXERCISE.....	3C-1
Annex D	MEMORY GAME.....	3D-1
Annex E	PUZZLES.....	3E-1
CHAPTER 4	PO 104 – DEVELOP A PERSONAL ACTIVITY PLAN	
Section 1	EO M104.01 – IDENTIFY ACTIVITIES THAT WILL HELP ACHIEVE A HEALTHY ACTIVE LIFESTYLE.....	4-1-1
Section 2	EO M104.02 – DEVELOP A PERSONAL ACTIVITY PLAN.....	4-2-1
Section 3	EO M104.03 – PARTICIPATE IN A DISCUSSION ON HYGIENIC PRACTICES DURING PHYSICAL ACTIVITY.....	4-3-1
Section 4	EO C104.01 – CREATE TEAM GOALS.....	4-4-1
Annex A	EXAMPLE OF AN ACTIVITY PLAN.....	4A-1
CHAPTER 5	PO 105 – PARTICIPATE IN RECREATIONAL SPORTS	
Section 1	EO M105.01 – PARTICIPATE IN ORGANIZED RECREATIONAL TEAM SPORTS.....	5-1-1
Section 2	EO C105.01 – PARTICIPATE IN AN ORGANIZED SPORTS TABLOID.....	5-2-1
Section 3	EO C105.02 – PARTICIPATE IN AN ORGANIZED INTRAMURAL SPORTS EVENT.....	5-3-1
Section 4	EO C105.03 – PARTICIPATE IN AN ORIENTEERING EVENT.....	5-4-1
Annex A	CANADIAN CADET ORGANIZATION LIST OF APPROVED SPORTS.....	5A-1

TABLE OF CONTENTS (Cont)

	PAGE
Annex B	RECREATIONAL SPORTS OVERVIEW..... 5B-1
Annex C	SAMPLE STRETCHES..... 5C-1
Annex D	SUGGESTED SPORTS TABLOID EVENTS..... 5D-1
Annex E	SPORTS TABLOID EVENTS EQUIPMENT LIST..... 5E-1
Annex F	STATIONS SCORE SHEETS..... 5F-1
Annex G	SPORTS TABLOID MASTER SCORE SHEET..... 5G-1
Annex H	TYPES OF TOURNAMENTS..... 5H-1
CHAPTER 6	PO 106 – FIRE THE CADET AIR RIFLE
Section 1	EO M106.01 – IDENTIFY THE PARTS AND THE CHARACTERISTICS OF THE DAISY 853C AIR RIFLE 6-1-1
Section 2	EO M106.02 – CARRY OUT SAFETY PRECAUTIONS ON THE CADET AIR RIFLE..... 6-2-1
Section 3	EO M106.03 – APPLY BASIC MARKSMANSHIP TECHNIQUES..... 6-3-1
Section 4	EO M106.04 – FOLLOW RULES AND COMMANDS ON AN AIR RIFLE RANGE 6-4-1
Section 5	EO M106.05 – CLEAN AND STORE THE CADET AIR RIFLE..... 6-5-1
Section 6	EO M106.CA – PARTICIPATE IN A FAMILIARIZATION SHOOT USING THE CADET AIR RIFLE..... 6-6-1
Section 7	EO C106.01 – PARTICIPATE IN A RECREATIONAL SHOOT USING THE CADET AIR RIFLE..... 6-7-1
Annex A	PARTS AND CHARACTERISTICS OF THE CADET AIR RIFLE..... 6A-1
Annex B	RANGE COMMANDS..... 6B-1
CHAPTER 7	PO 107 – SERVE IN AN AIR CADET SQUADRON
Section 1	EO M107.01 – DISCUSS YEAR ONE TRAINING..... 7-1-1
Section 2	EO M107.02 – IDENTIFY AIR CADET RANKS AND AIR OFFICER RANKS..... 7-2-1
Section 3	EO M107.03 – OBSERVE THE RULES AND PROCEDURES FOR THE PAYING OF COMPLIMENTS..... 7-3-1
Section 4	EO M107.04 – STATE THE AIMS AND MOTTO OF THE AIR CADET PROGRAM..... 7-4-1
Section 5	EO M107.05 – WEAR THE AIR CADET UNIFORM..... 7-5-1
Section 6	EO M107.06 – DISCUSS SUMMER TRAINING OPPORTUNITIES..... 7-6-1
Section 7	EO C107.01 – MAINTAIN THE AIR CADET UNIFORM..... 7-7-1
Section 8	EO C107.02 – IDENTIFY THE AIR FORCE NCM RANK STRUCTURE OF THE CF..... 7-8-1
Section 9	EO C107.03 – TOUR THE SQUADRON..... 7-9-1
Section 10	EO C107.04 – PARTICIPATE IN AN ACTIVITY ABOUT THE HISTORY OF THE SQUADRON..... 7-10-1
Annex A	AIR CADET RANKS..... 7A-1
Annex B	AIR OFFICER RANKS..... 7B-1
Annex C	PUZZLES..... 7C-1

TABLE OF CONTENTS (Cont)

		PAGE
Annex D	RECOGNIZE YOUR UNIFORM ACTIVITY.....	7D-1
Annex E	NON-COMMISSIONED MEMBER (NCM) RANKS OF THE AIR ELEMENT OF THE CANADIAN FORCES.....	7E-1
Annex F	EXAMPLE MAP.....	7F-1
Annex G	SQUADRON PASSPORT.....	7G-1
Annex H	MEMORIAL AWARDS.....	7H-1
CHAPTER 8	PO 108 – PARTICIPATE IN AN ANNUAL CEREMONIAL REVIEW (ACR) PARADE	
Section 1	EO M108.01 – ADOPT THE POSITIONS OF ATTENTION, STAND AT EASE AND STAND EASY.....	8-1-1
Section 2	EO M108.02 – EXECUTE A SALUTE AT THE HALT WITHOUT ARMS.....	8-2-1
Section 3	EO M108.03 – EXECUTE TURNS AT THE HALT.....	8-3-1
Section 4	EO M108.04 – CLOSE TO THE RIGHT AND LEFT.....	8-4-1
Section 5	EO M108.05 – EXECUTE PACES FORWARD AND TO THE REAR.....	8-5-1
Section 6	EO M108.06 – EXECUTE THE MOVEMENTS REQUIRED FOR A RIGHT DRESS.....	8-6-1
Section 7	EO M108.07 – EXECUTE AN OPEN ORDER AND CLOSE ORDER MARCH.....	8-7-1
Section 8	EO M108.08 – MARCH AND HALT IN QUICK TIME.....	8-8-1
Section 9	EO M108.09 – EXECUTE MARKING TIME, FORWARD, AND HALTING IN QUICK TIME.....	8-9-1
Section 10	EO M108.10 – EXECUTE A SALUTE ON THE MARCH.....	8-10-1
Section 11	EO M108.11 – PAY COMPLIMENTS WITH A SQUAD ON THE MARCH.....	8-11-1
Section 12	EO M108.CA – PARTICIPATE IN AN ANNUAL CEREMONIAL REVIEW PARADE.....	8-12-1
Section 13	EO C108.01 – EXECUTE SUPPLEMENTARY DRILL MOVEMENTS.....	8-13-1
Section 14	EO C108.02 – PARTICIPATE IN A DRILL COMPETITION.....	8-14-1
Annex A	ORDERING A FLIGHT ON PARADE.....	8A-1
Appendix 1	ORDERING A FLIGHT ON PARADE.....	8A1-1
Appendix 2	FLIGHT IN LINE AND FLIGHT IN COLUMN OF ROUTE DIAGRAMS.....	8A2-1
Annex B	FORMING UP A SQUADRON.....	8B-1
Appendix 1	FORMING UP A SQUADRON.....	8B1-1
Appendix 2	SQUADRON IN LINE AND SQUADRON IN COLUMN OF ROUTE DIAGRAMS..	8B2-1
Annex C	MARCHING ON AND MARCHING OFF THE FLAGS.....	8C-1
Appendix 1	MARCHING ON AND MARCHING OFF THE FLAG(S).....	8C1-1
Appendix 2	MARCHING ON AND MARCHING OFF THE FLAGS DIAGRAMS.....	8C2-1
Annex D	ANNUAL CEREMONIAL REVIEW PARADE SEQUENCE OF EVENTS.....	8D-1
Appendix 1	FLIGHT PARADE FORMATION WITH FLAG PARTY.....	8D1-1
Appendix 2	THE INSPECTION.....	8D2-1
Appendix 3	RECEPTION OF AWARDS OR PRESENTATIONS.....	8D3-1

TABLE OF CONTENTS (Cont)

		PAGE
Annex E	GUIDELINES FOR THE CONDUCT OF A YEAR ONE DRILL COMPETITION....	8E-1
Appendix 1	DRILL SEQUENCE.....	8E1-1
Appendix 2	WORDS OF COMMAND.....	8E2-1
Appendix 3	TEAM EVALUATION.....	8E3-1
Appendix 4	TEAM CAPTAIN EVALUATION.....	8E4-1
Appendix 5	MASTER SCORE SHEET.....	8E5-1
CHAPTER 9	PO 120 – PARTICIPATE IN CANADIAN FORCES (CF) FAMILIARIZATION ACTIVITIES	
Section 1	EO M120.01 – DISCUSS THE ROLES OF THE CANADIAN FORCES (CF).....	9-1-1
Section 2	EO M120.02 – DISCUSS OPPORTUNITIES IN THE CANADIAN FORCES (CF).	9-2-1
Section 3	EO C120.03 – CONTACT A CF MEMBER ON DEPLOYMENT.....	9-3-1
Annex A	ROLES OF THE CANADIAN FORCES.....	9A-1
CHAPTER 10	PO 121 – PARTICIPATE IN CANADIAN AVIATION, AEROSPACE AND AERODROME OPERATIONS COMMUNITY FAMILIARIZATION ACTIVITIES	
	EO M121.01 – DISCUSS AVIATION OPPORTUNITIES.....	10-1
Annex A	CAREER INVESTIGATION SHEET.....	10A-1
Annex B	CAREER INFORMATION ENVELOPES.....	10B-1
CHAPTER 11	PO 129 – COMMUNICATE USING THE PHONETIC ALPHABET AND NUMBERS	
	EO M129.01 – RECITE THE PHONETIC ALPHABET.....	11-1
CHAPTER 12	PO 130 – PARTICIPATE IN AVIATION ACTIVITIES	
Section 1	EO M130.01 – IDENTIFY AIRCRAFT AS MILITARY, CIVILIAN AND CADET.....	12-1-1
Section 2	EO M130.02 – DESCRIBE THE MAIN COMPONENTS OF AN AIRPLANE.....	12-2-1
Section 3	EO M130.03 – CONSTRUCT A MODEL AIRPLANE.....	12-3-1
Section 4	EO M130.04 – WATCH <i>ON CANADIAN WINGS</i> VIDEO.....	12-4-1
Section 5	EO C130.01 – PARTICIPATE IN A WALK-AROUND AIRCRAFT INSPECTION .	12-5-1
Section 6	EO C130.02 – IDENTIFY INTERNATIONAL AIRCRAFT.....	12-6-1
Annex A	AIRCRAFT IDENTIFICATION ACTIVITY.....	12A-1
Annex B	AIRCRAFT PICTURES.....	12B-1
Annex C	MAIN COMPONENTS OF AN AIRPLANE PUZZLE.....	12C-1
Annex D	FUSELAGE AND WING PUZZLE.....	12D-1
Annex E	EMPENNAGE PUZZLE.....	12E-1
Annex F	LANDING GEAR AND PROPULSION SYSTEM PUZZLE.....	12F-1
Annex G	PAPER MODEL ASSEMBLY INSTRUCTIONS.....	12G-1
Annex H	PAPER MODEL AIRPLANE PARTS.....	12H-1
Annex I	AMERICAN, BRITISH AND RUSSIAN AIRCRAFT PICTURES.....	12I-1

TABLE OF CONTENTS (Cont)

		PAGE
CHAPTER 13 PO 140 – PARTICIPATE IN AEROSPACE ACTIVITIES		
Section 1	EO M140.01 – BUILD AND LAUNCH A MODEL ROCKET.....	13-1-1
Section 2	EO C140.01 – PARTICIPATE IN AN ACTIVITY ABOUT CANADIAN ASTRONAUTS.....	13-2-1
Annex A	MODEL ROCKET.....	13A-1
Annex B	MODEL ROCKET – LAUNCHING PROCESS.....	13B-1
Annex C	BIOGRAPHICAL DATA – MARC GARNEAU.....	13C-1
Annex D	BIOGRAPHICAL DATA – ROBERTA LYNN BONDAR.....	13D-1
Annex E	BIOGRAPHICAL DATA – CHRIS A. HADFIELD.....	13E-1
Annex F	BIOGRAPHICAL DATA – JULIE PAYETTE.....	13F-1
Annex G	QUESTIONS.....	13G-1
 CHAPTER 14 PO 160 – PARTICIPATE IN AERODROME OPERATIONS ACTIVITIES		
Section 1	EO M160.01 – IDENTIFY MAJOR AERODROME COMPONENTS.....	14-1-1
Section 2	EO M160.02 – IDENTIFY FEATURES OF A RUNWAY.....	14-2-1
Section 3	EO M160.03 – CONSTRUCT A MODEL AERODROME.....	14-3-1
Annex A	AIRPORT FAMILIARIZATION.....	14A-1
 CHAPTER 15 PO 190 – PARTICIPATE IN A FIELD EXERCISE		
Section 1	EO M190.01 – PACK PERSONAL EQUIPMENT FOR A FIELD EXERCISE.....	15-1-1
Section 2	EO M190.02 – MAINTAIN PERSONAL EQUIPMENT AND HYGIENE IN THE FIELD.....	15-2-1
Section 3	EO M190.03 – OBSERVE SITE POLICIES AND PROCEDURES.....	15-3-1
Section 4	EO M190.04 – DISCUSS SURVIVAL PSYCHOLOGY.....	15-4-1
Section 5	EO M190.05 – IDENTIFY TYPES OF SHELTERS.....	15-5-1
Section 6	EO M190.06 – CONSTRUCT A HOOTCHIE STYLE SHELTER.....	15-6-1
Section 7	EO M190.07 – LIGHT, MAINTAIN AND EXTINGUISH A FIRE.....	15-7-1
Section 8	EO C190.02 – IDENTIFY ENVIRONMENTAL INJURIES.....	15-8-1
Section 9	EO C190.03 – TIE KNOTS AND LASHINGS.....	15-9-1
Section 10	EO C190.04 – RESPECT THE ENVIRONMENT IN THE FIELD.....	15-10-1
Section 11	EO C190.05 – IDENTIFY REGIONAL WILDLIFE.....	15-11-1
Section 12	EO C190.06 – COLLECT DRINKING WATER IN THE FIELD.....	15-12-1
Annex A	SURVIVAL SCENARIO.....	15A-1
Annex B	SUGGESTED ANSWERS FOR SURVIVAL SCENARIO – INSTRUCTOR USE ONLY.....	15B-1
Annex C	SHELTERS SET-UP.....	15C-1
Annex D	RECOGNIZE ENVIRONMENTAL INJURIES ACTIVITY.....	15D-1
Annex E	ANSWER KEY – RECOGNIZE ENVIRONMENTAL INJURIES ACTIVITY.....	15E-1

THIS PAGE INTENTIONALLY LEFT BLANK

LIST OF FIGURES

FIGURE	TITLE	PAGE
1-1-1	St. George's Cross.....	1-1-3
1-1-2	Fleur-de-Lis.....	1-1-3
1-1-3	Two Crossed Royal Union Flag.....	1-1-3
1-1-4	Present Day Royal Union Flag.....	1-1-4
1-1-5	Canadian Red Ensign.....	1-1-4
1-1-6	The National Flag of Canada.....	1-1-4
1-1-7	The Canadian National Anthem.....	1-1-5
1-1-8	The Canadian Coat of Arms.....	1-1-6
1-1-9	The Shield.....	1-1-7
1-1-10	The Ribbon.....	1-1-7
1-1-11	The Crest.....	1-1-7
1-1-12	The Supporters.....	1-1-8
1-1-13	The Motto.....	1-1-8
1-1-14	The Four Floral Emblems.....	1-1-8
1-1-15	The Imperial Crown.....	1-1-8
1-1-16	The Maple Leaf.....	1-1-10
5-1-1	Instructor in Centre of Warm Up Circle.....	5-1-4
5-1-2	Instructor at Front With Assistant Instructors.....	5-1-4
5-1-3	Instructor in Centre of Cool Down Circle.....	5-1-7
5-1-4	Instructor at Front With Assistant Instructors.....	5-1-8
5-2-1	Instructor in Centre of Warm Up Circle.....	5-2-4
5-2-2	Instructor at Front With Assistant Instructors.....	5-2-4
5-2-3	Sample Tabloid Set-up.....	5-2-7
5-2-4	Instructor in Centre of Cool Down Circle.....	5-2-9
5-2-5	Instructor at Front With Assistant Instructors.....	5-2-9
5-3-1	Instructor in Centre of Warm Up Circle.....	5-3-4
5-3-2	Instructor at Front With Assistant Instructors.....	5-3-4
5-3-3	Instructor in Centre of Cool Down Circle.....	5-3-7
5-3-4	Instructor at Front With Assistant Instructors.....	5-3-8
5-4-1	Example of IOF Symbols.....	5-4-3
5-4-2	Orienteering Compass.....	5-4-3
5-4-3	Control Markers.....	5-4-4
5-4-4	Silva Score Card.....	5-4-5
5-4-5	Orienting a Compass to Map.....	5-4-6
5-4-6	Thumbing Position.....	5-4-6
5-4-7	Instructor in Centre of Warm Up Circle.....	5-4-11
5-4-8	Instructor at Front With Assistant Instructors.....	5-4-11
5-4-9	Sample Start Grid.....	5-4-12
5-4-10	Sample Recording Sheet.....	5-4-13
5-4-11	Instructor in Centre of Cool Down Circle.....	5-4-16
5-4-12	Instructor at Front With Assistant Instructors.....	5-4-16
5B-1	Baseball Diamond.....	5B-4

LIST OF FIGURES (Cont)

FIGURE	TITLE	PAGE
5B-2	Basketball Court.....	5B-6
5B-3	Football Field.....	5B-9
5B-4	Hockey Set-up.....	5B-11
5B-5	Lacrosse Field.....	5B-13
5B-6	Ringette Ice/Sporting Venue.....	5B-15
5B-7	Soccer Field.....	5B-17
5B-8	Baseball Diamond (Can Be Used for Soccer Baseball).....	5B-20
5B-9	Softball Field.....	5B-23
5B-10	Ultimate Frisbee Field.....	5B-25
5B-11	Volleyball Court.....	5B-27
5C-1	Neck Stretch.....	5C-1
5C-2	Neck Stretch.....	5C-1
5C-3	Back of Neck Stretch.....	5C-1
5C-4	Shoulder Push.....	5C-2
5C-5	Shoulder Shrugs.....	5C-2
5C-6	Arm Rotators.....	5C-2
5C-7	Wrist Rotations.....	5C-3
5C-8	Triceps Stretch.....	5C-3
5C-9	Side Stretch (Oblique).....	5C-4
5C-10	Full Back Stretch.....	5C-5
5C-11	Lower Back Stretch.....	5C-5
5C-12	Back Stretch.....	5C-5
5C-13	Upper Back Stretch.....	5C-5
5C-14	Hip and Groin Stretch.....	5C-6
5C-15	Hip and Groin Stretch.....	5C-6
5C-16	Hip Stretch.....	5C-6
5C-17	Hip Flexor.....	5C-6
5C-18	Ankle Rotations.....	5C-7
5C-19	Calf Stretch.....	5C-7
5C-20	Quadriceps Stretch.....	5C-7
5C-21	Hamstring Stretch.....	5C-8
5H-1	Ladder Tournament.....	5H-1
5H-2	Pyramid Tournament.....	5H-2
5H-3	Single Elimination Tournament.....	5H-5
5H-4	Double Elimination Tournament Example.....	5H-6
5H-5	Double Elimination Tournament.....	5H-7
6-1-1	Parts of the Cadet Air Rifle.....	6-1-2
6-2-1	Safety Catch.....	6-2-3
6-2-2	Safety Catch Detail View.....	6-2-3
6-2-3	Safety Rod.....	6-2-4
6-3-1	Prone Position.....	6-3-3
6-3-2	Prone Position (Front).....	6-3-4

LIST OF FIGURES (Cont)

FIGURE	TITLE	PAGE
6-3-3	Prone Position (Side).....	6-3-4
6-3-4	Sight Alignment.....	6-3-5
6-3-5	Line of White.....	6-3-5
6-3-6	Sight Picture.....	6-3-6
6-3-7	Pumping the Air Rifle.....	6-3-7
7-2-1	Leading Air Cadet Rank Badge.....	7-2-2
7-2-2	Corporal Rank Badge.....	7-2-2
7-2-3	Sergeant Rank Badge.....	7-2-3
7-2-4	Flight Sergeant Rank Badge.....	7-2-3
7-2-5	Warrant Officer Second Class Rank Badge.....	7-2-3
7-2-6	Warrant Officer First Class Rank Badge.....	7-2-4
7-2-7	Officer Cadet Rank.....	7-2-6
7-2-8	Second Lieutenant Rank.....	7-2-6
7-2-9	Lieutenant Rank.....	7-2-6
7-2-10	Captain Rank.....	7-2-6
7-2-11	Major Rank.....	7-2-7
7-2-12	Lieutenant Colonel Rank.....	7-2-7
7-2-13	Colonel Rank.....	7-2-7
7-2-14	Brigadier General Rank.....	7-2-7
7-2-15	Major General Rank.....	7-2-8
7-2-16	Lieutenant General Rank.....	7-2-8
7-2-17	General Rank.....	7-2-8
7-3-1	Entering and Leaving an Office.....	7-3-5
7-5-1	Placement of Wedge Insignia.....	7-5-2
7-5-2	Method for Tying a Windsor Knot.....	7-5-3
7-5-3	Method for Tying a Four-in-Hand Knot.....	7-5-4
7-5-4	Right Breast Pocket with Nametag.....	7-5-5
7-5-5	Method of Lacing Boots.....	7-5-7
7-5-6	Squadron Shoulder Flash.....	7-5-8
7-5-7	LAC Rank Badge.....	7-5-8
7-5-8	Taper Trimmed Haircut – Conventional.....	7-5-9
7-5-9	Taper Trimmed Haircut – Straight Back Appearance.....	7-5-10
7-5-10	Moustache.....	7-5-10
7-5-11	Female Short Hairstyles.....	7-5-10
7-5-12	Hair Styled in Bun.....	7-5-11
7-5-13	Single Braid.....	7-5-11
7-5-14	Double Braids.....	7-5-11
7-5-15	Stud Earring Centred in Earlobe.....	7-5-12
7-6-1	Map of Summer Training Centres Across Canada.....	7-6-2
7-8-1	Private Recruit Rank.....	7-8-2
7-8-2	Private Rank.....	7-8-2
7-8-3	Corporal Rank.....	7-8-2

LIST OF FIGURES (Cont)

FIGURE	TITLE	PAGE
7-8-4	Master Corporal Rank.....	7-8-2
7-8-5	Sergeant Rank.....	7-8-3
7-8-6	Warrant Officer Rank.....	7-8-3
7-8-7	Master Warrant Officer Rank.....	7-8-3
7-8-8	Chief Warrant Officer Rank.....	7-8-3
8-1-1	The Position of Attention.....	8-1-3
8-1-2	Fists at Position of Attention.....	8-1-3
8-1-3	Squad One – Stand at Ease.....	8-1-4
8-1-4	The Position of Stand at Ease.....	8-1-5
8-1-5	Stand Easy From Stand at Ease.....	8-1-7
8-2-1	Saluting to the Front Without Arms.....	8-2-3
8-2-2	Saluting to the Right and Left.....	8-2-5
8-3-1	Squad One – Right Turn at the Halt.....	8-3-3
8-3-2	Squad Two – Right Turn at the Halt.....	8-3-3
8-3-3	Squad One – About Turn at the Halt.....	8-3-5
8-3-4	Squad Two – About Turn at the Halt.....	8-3-6
8-6-1	Dressing a Squad.....	8-6-2
8-7-1	Open Order March in Three Ranks.....	8-7-2
8-7-2	Open Order March in Two Ranks.....	8-7-3
8-8-1	Marching in Quick Time.....	8-8-2
8-8-2	Halting in Quick Time.....	8-8-4
8-9-1	Marking Time in Quick Time	8-9-2
8-10-1	Saluting on the March.....	8-10-2
8-11-1	Eyes Right on the March.....	8-11-3
8A2-1	Flight in Line.....	8A2-1
8A2-2	Flight in Column of Route.....	8A2-2
8B2-1	Squadron in Line.....	8B2-1
8B2-2	Squadron in Column of Route.....	8B2-2
8C-1	One Flag With Escort.....	8C-1
8C-2	Flag Party – Two Flags With Escort.....	8C-1
8C2-1	Marching On the Flags.....	8C2-1
8C2-2	Marching Off the Flags.....	8C2-2
8D1-1	Flight Parade Formation With Flag Party in Column of Route.....	8D1-1
8D1-2	Flight Parade Formation With Flag Party Flight in Line.....	8D1-2
8D1-3	Squadron Parade Formation With Flag Party Squadron in Line.....	8D1-3
8D1-4	Squadron Parade Formation With Flag Party Squadron in Column of Route.....	8D1-4
8D2-1	The Inspection.....	8D2-1
8D3-1	Falling Out/In of Formation.....	8D3-1
8D3-2	Reporting.....	8D3-2
12-1-1	CT-114 Tutor.....	12-1-2
12-1-2	CC-115 Buffalo.....	12-1-2
12-1-3	CC-130 Hercules.....	12-1-3

LIST OF FIGURES (Cont)

FIGURE	TITLE	PAGE
12-1-4	CC-150 Polaris.....	12-1-3
12-1-5	CP-140 Aurora.....	12-1-3
12-1-6	CF-18 Hornet.....	12-1-4
12-1-7	CH-146 Griffon.....	12-1-4
12-1-8	CH-149 Cormorant.....	12-1-4
12-1-9	Cessna 172.....	12-1-5
12-1-10	Piper PA-28.....	12-1-5
12-1-11	Boeing 737.....	12-1-6
12-1-12	Airbus A320.....	12-1-6
12-1-13	SGS 233A Glider.....	12-1-7
12-1-14	Bellanca Scout.....	12-1-7
12-1-15	L19 Bird Dog.....	12-1-7
12-2-1	Airplane Components.....	12-2-4
12-2-2	Empennage.....	12-2-6
12-2-3	Nose Gear vs Tail Gear.....	12-2-7
12-3-1	Airplane Components.....	12-3-3
12-3-2	Fuselage Assembly.....	12-3-5
12-3-3	Wing Assembly.....	12-3-6
12-3-4	Tail Assembly.....	12-3-6
12-3-5	Propeller Assembly.....	12-3-6
12-3-6	Landing Gear Assembly.....	12-3-7
12-6-1	F/A-22A Raptor.....	12-6-2
12-6-2	F/A-22A Raptor.....	12-6-3
12-6-3	A-10 Thunderbolt II	12-6-3
12-6-4	A-10 Thunderbolt II.....	12-6-4
12-6-5	F-117A Nighthawk.....	12-6-4
12-6-6	F-117A Nighthawk.....	12-6-5
12-6-7	B-52 Stratofortess.....	12-6-5
12-6-8	B-52 Stratofortess.....	12-6-6
12-6-9	EF-2000 Typhoon.....	12-6-7
12-6-10	EF-2000 Typhoon.....	12-6-7
12-6-11	EF-2000 Typhoon.....	12-6-7
12-6-12	Jaguar GR3.....	12-6-8
12-6-13	Jaguar GR3.....	12-6-8
12-6-14	MiG-29 Fulcrum.....	12-6-9
12-6-15	MiG-29 Fulcrum.....	12-6-10
12-6-16	Antonov AN-124-100.....	12-6-10
12-6-17	Antonov AN-124-100.....	12-6-11
12A-1	Slide No. 1.....	12A-1
12A-2	Slide No. 2.....	12A-2
12A-3	Slide No. 3.....	12A-3
12A-4	Slide No. 4.....	12A-4

LIST OF FIGURES (Cont)

FIGURE	TITLE	PAGE
12A-5	Slide No. 5.....	12A-5
12A-6	Slide No. 6.....	12A-6
12A-7	Slide No. 7.....	12A-7
12A-8	Slide No. 8.....	12A-8
12A-9	Slide No. 9.....	12A-9
12A-10	Slide No. 10.....	12A-10
12A-11	Slide No. 11.....	12A-11
12A-12	Slide No. 12.....	12A-12
12A-13	Slide No. 13.....	12A-13
12A-14	Slide No. 14.....	12A-14
12A-15	Slide No. 15.....	12A-15
12A-16	Slide No. 16.....	12A-16
12A-17	Slide No. 17.....	12A-17
12A-18	Slide No. 18.....	12A-18
12A-19	Slide No. 19.....	12A-19
12A-20	Slide No. 20.....	12A-20
12A-21	Slide No. 21.....	12A-21
12A-22	Slide No. 22.....	12A-22
12A-23	Slide No. 23.....	12A-23
12A-24	Slide No. 24.....	12A-24
12A-25	Slide No. 25.....	12A-25
12A-26	Slide No. 26.....	12A-26
12A-27	Slide No. 27.....	12A-27
12A-28	Slide No. 28.....	12A-28
12A-29	Slide No. 29.....	12A-29
12A-30	Slide No. 30.....	12A-30
12A-31	Slide No. 31.....	12A-31
12A-32	Slide No. 32.....	12A-32
12A-33	Slide No. 33.....	12A-33
12A-34	Slide No. 34.....	12A-34
12A-35	Slide No. 35.....	12A-35
12A-36	Slide No. 36.....	12A-36
12A-37	Slide No. 37.....	12A-37
12A-38	Slide No. 38.....	12A-38
12B-1	Slide No. 1.....	12B-1
12B-2	Slide No. 2.....	12B-2
12B-3	Slide No. 3.....	12B-3
12B-4	Slide No. 4.....	12B-4
12B-5	Slide No. 5.....	12B-5
12B-6	Slide No. 6.....	12B-6
12B-7	Slide No. 7.....	12B-7
12B-8	Slide No. 8.....	12B-8

LIST OF FIGURES (Cont)

FIGURE	TITLE	PAGE
12B-9	Slide No. 9.....	12B-9
12B-10	Slide No. 10.....	12B-10
12B-11	Slide No. 11.....	12B-11
12B-12	Slide No. 12.....	12B-12
12B-13	Slide No. 13.....	12B-13
12B-14	Slide No. 14.....	12B-14
12B-15	Slide No. 15.....	12B-15
12G-1	Fuselage Assembly.....	12G-1
12G-2	Wing Assembly.....	12G-1
12G-3	Tail Assembly.....	12G-1
12G-4	Propeller Assembly.....	12G-1
12G-5	Landing Gear Assembly.....	12G-1
14-1-1	Aerodrome Movement Areas.....	14-1-3
14-1-2	Windssock and Wind T.....	14-1-4
14-2-1	Runway Lights.....	14-2-2
14-2-2	Runway Markings.....	14-2-4
14-2-3	Runway Danger Markings.....	14-2-4
14-3-1	Runway Markings.....	14-3-3
14-3-2	Runway Danger Markings.....	14-3-3
14-3-3	Aerodrome Movement Areas.....	14-3-4
14-3-4	Windssock and Wind T.....	14-3-4
14A-1	Runway.....	14A-1
14A-2	Taxiway.....	14A-2
14A-3	Apron.....	14A-3
14A-4	Hangar.....	14A-4
14A-5	Control Tower.....	14A-5
14A-6	Terminal Building.....	14A-6
14A-7	Windssock.....	14A-7
14A-8	Flying School.....	14A-8
15-1-1	A Well-organized Backpack.....	15-1-6
15-2-1	Steps to Knife Sharpening.....	15-2-3
15-5-1	Cave Shelter.....	15-5-4
15-5-2	Fallen Tree Shelter.....	15-5-5
15-5-3	A-frame Shelter.....	15-5-6
15-5-4	Lean-to Shelter.....	15-5-6
15-6-1	Two Military Style Ground Sheets.....	15-6-2
15-6-2	Appropriate Supplies.....	15-6-2
15-6-3	Grommet.....	15-6-3
15-6-4	Zippering Ground Sheets.....	15-6-3
15-6-5	Two Ground Sheets Zipped Together.....	15-6-4
15-6-6	Tying Shelter to a Tree.....	15-6-4
15-6-7	Shelter Tied to Two Trees.....	15-6-5

LIST OF FIGURES (Cont)

FIGURE	TITLE	PAGE
15-6-8	Pulling Pegs Tight.....	15-6-5
15-6-9	Pegged Grommet.....	15-6-5
15-6-10	Shelter 5 Centimetres Above the Ground.....	15-6-6
15-6-11	Flush, Tight Surface.....	15-6-6
15-6-12	Doors Tied Together.....	15-6-7
15-6-13	Completed Hootchie Style Shelter.....	15-6-7
15-7-1	Forest Fire Danger Rating System.....	15-7-2
15-7-2	Strong Wind.....	15-7-2
15-7-3	Fire Triangle.....	15-7-5
15-7-4	Matches.....	15-7-7
15-7-5	Flint and Steel.....	15-7-8
15-7-6	Magnifying Glass.....	15-7-8
15-7-7	Battery and Steel Wool.....	15-7-8
15-9-1	Parts of a Rope.....	15-9-2
15-9-2	Reef Knot.....	15-9-3
15-9-3	Sheet Bend.....	15-9-4
15-9-4	Clove Hitch.....	15-9-5
15-9-5	Bowline.....	15-9-6
15-9-6	Round Lashing.....	15-9-7
15-9-7	Square Lashing.....	15-9-9
15-9-8	Sheer Lashing.....	15-9-10
15-9-9	Tripod Lashing.....	15-9-12
15-12-1	Rain Collector.....	15-12-4
15-12-2	Dew Collection.....	15-12-5
15-12-3	Collecting Condensation.....	15-12-5
15-12-4	Collecting Condensation From Plants.....	15-12-6
15-12-5	Pitcher Plant.....	15-12-6
15-12-6	Cactus.....	15-12-7
15-12-7	Solar Still.....	15-12-7
15-12-8	Water Table.....	15-12-8
15C-1	A-frame Shelter.....	15C-1
15C-2	A-frames.....	15C-4
15C-3	Joining of the Tie Beams.....	15C-5
15C-4	Raising One Side.....	15C-5
15C-5	Lacing the Tent Canvas.....	15C-5
15C-6	Half of the Tent Is Laced.....	15C-6
15C-7	Modular Tent.....	15C-6
15C-8	Folding of the Centre Section.....	15C-7
15C-9	Folding the Outside Walls.....	15C-7

CHAPTER 1

PO 101 – PARTICIPATE IN CITIZENSHIP ACTIVITIES



COMMON TRAINING INSTRUCTIONAL GUIDE



SECTION 1

EO M101.01 – PARTICIPATE IN A DISCUSSION ON CANADIAN SYMBOLS

Total Time:

30 min

INTRODUCTION

PRE-LESSON INSTRUCTIONS

A complete list of resources needed for the instruction of this EO is located at Chapter 2 of the QSP. Specific uses for said stores are identified throughout the Instructional Guide, within the teaching point for which they are required.

Prior to instructing this lesson the instructor is required to:

- review the lesson content, and become familiar with the material;
- prepare a suitable classroom area;
- prepare a large diagram or an OHP transparency of the Canadian Coat of Arms;
- prepare pre-cut circles of yellow bristol board;
- prepare envelopes filled with pieces of the Canadian Coat of Arms; and
- have flipchart paper and markers readily available.

PRE-LESSON ASSIGNMENT

N/A.

APPROACH

The interactive lecture method was chosen as it allows the instructor to make a semi-formal presentation of the material where the cadets can participate by asking or responding to questions and commenting on the material. For this lesson, this method is most effective as it matches well the taxonomic level of the material and is age-appropriate by virtue of its participatory nature.

The small group activity was selected to allow for maximum participation in the learning process. It is an interactive way to illustrate and substantiate the lesson material in a concrete manner.

REVIEW

N/A.

OBJECTIVES

By the end of this lesson the cadet shall be expected to recognize and/or appreciate the significance of The National Flag of Canada, the national anthem, the Canadian Coat of Arms and the maple leaf.

IMPORTANCE

Recognizing and knowing the significance of Canadian symbols is an important aspect of being a Canadian citizen and a member of the Canadian Cadet Movement.

Teaching Point 1

Discuss The National Flag of Canada

Time: 7 min

Method: Activity/Interactive Lecture

ACTIVITY

Time: 3 min

OBJECTIVE

An introductory brainstorming activity to focus the mind around Canadian symbols.

RESOURCES

- Flipchart paper.
- Markers.

ACTIVITY LAYOUT

- Divide cadets into small groups.
- Issue one piece of flipchart paper and several markers to each group.
- Direct cadets to brainstorm symbols they associate with Canada. Have the cadets draw these symbols on the provided flipchart paper. When the cadets have completed their illustrations, direct each group to present their thoughts to the larger group.
- When cadets have finished presenting their symbols, provide positive feedback and proceed with TP1.

SAFETY

N/A.

INSTRUCTOR GUIDELINES

- Ensure cadets complete this activity within the time allotted.
- Supervise groups throughout the activity.



If the cadets present symbols included in this lesson, the instructor shall link back to them when delivering the lesson material.



The first Canadian flags should be discussed briefly with more emphasis placed on the current national flag.

FIRST CANADIAN FLAGS

St. George's Cross

The St. George's Cross was an English flag of the 15th century. It was carried by John Cabot and flown over Canadian soil when he reached the east coast of Canada in 1497.

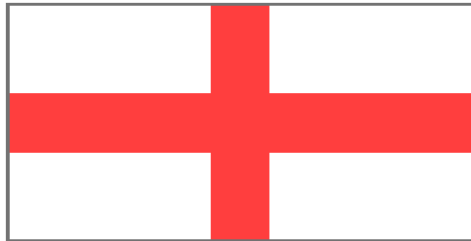

Canadian Heritage Website, www.canadianheritage.gc.ca

Figure 1-1-1 St. George's Cross

Fleur-de-Lis

When Jacques Cartier landed and claimed the new world for France in 1534, the Fleur-de-Lis was flown as a symbol of French sovereignty in Canada. It was flown until the early 1760s when Canada was surrendered to the United Kingdom.

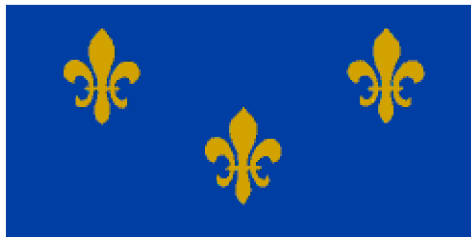

Canadian Heritage Website, www.canadianheritage.gc.ca

Figure 1-1-2 Fleur-de-Lis

Royal Union Flag

The two crossed Royal Union Flag was the official British flag in the early 1760s. This flag was flown over Canadian soil until the Act of the Union between Great Britain and Ireland in 1801 when Ireland's diagonal cross of St. Patrick was incorporated. This gave the Royal Union Flag its present day configuration.



Canadian Heritage Website, www.canadianheritage.gc.ca

Figure 1-1-3 Two Crossed Royal Union Flag



Canadian Heritage Website, www.canadianheritage.gc.ca

Figure 1-1-4 Present Day Royal Union Flag

Canadian Red Ensign

The Canadian Red Ensign is a red flag with the Royal Union Flag in the corner. It was created in 1707 as the flag of the British Merchant Marine. It replaced the Royal Union flag on government buildings abroad in 1924. Starting in 1945, it was flown on federal buildings in Canada until a new national flag was adopted.



Canadian Heritage Website, www.canadianheritage.gc.ca

Figure 1-1-5 Canadian Red Ensign

THE CURRENT NATIONAL FLAG OF CANADA

The red and white maple leaf flag replaced the Canadian Red Ensign on February 15th, 1965. The maple leaf has been a national emblem of Canada since 1860 and was deemed a suitable symbol for the current national flag. During the crusades, two different colours distinguished the countries of England and France, England by the colour white and France by red. Throughout history, red and white have been the colours of England and France. In 1921, red and white were approved as the official colours of Canada in the proclamation of the Royal Arms.



Canadian Heritage Website, www.canadianheritage.gc.ca

Figure 1-1-6 The National Flag of Canada

CONFIRMATION OF TEACHING POINT 1

QUESTIONS

- Q1. What was the first flag flown over Canadian soil?
- Q2. What are the two official colours of Canada that are incorporated in the current National Flag of Canada?
- Q3. On what date was the current National Flag of Canada made official?

ANTICIPATED ANSWERS

- A1. The St. George's Cross.
- A2. Red and white.
- A3. 15 February 1965.

Teaching Point 2**Discuss the Canadian National Anthem**

Time: 5 min

Method: Interactive Lecture

THE CANADIAN NATIONAL ANTHEM

“O Canada” was proclaimed as Canada’s national anthem on July 1st, 1980. It was first performed 100 years previous on June 24th, 1880. The music was composed by Calixa Lavallée. The French lyrics were written by Sir Adolphe-Basile Routhier. The official English lyrics were written by Mr. Justice Robert Stanley Weir in 1908. In 1968, a Special Joint Committee of the Senate and the House of Commons made changes to the English lyrics. The French lyrics remain unaltered.

NATIONAL ANTHEM / HYMNE NATIONAL
O CANADA

The image shows the musical score for the National Anthem of Canada. It consists of ten staves of music in G major, 4/4 time. The lyrics are provided in both English and French below the notes.

O Can - a - da! Our home and na - tive
O Can - a - da! Ter - re de nos ai -

land!
eur, Ton front est ceint in de

all thy sons com - mend With glow - ing hearts we
fleu - rons glo - ri - eux! Carton bras sai - por - ter l'é -

see thee rise, The True North strong and free! From
pé - é - e, Il sait por - ter la croix! Ton his -

far and wide O Can - a - da, we stand on guard for thee.
toire est une é - po - pé - é - e Des plus bril - lants ex - ploits

God keep our land glo - rious and free!
Et ta va - leur, de foi trem - pé,

O Can - a - da, we stand on guard for thee.
Pro - té - ge - ra nos foy - ers et nos droits.

O Can - a - da, we stand on guard for thee.
Pro - té - ge - ra nos foy - ers et nos droits.

Canadian Heritage Website, www.canadianheritage.gc.ca

Figure 1-1-7 The Canadian National Anthem



The instructor may have the cadets sing or listen to the national anthem.

CONFIRMATION OF TEACHING POINT 2

QUESTIONS

- Q1. On what date did the national anthem become official?
- Q2. Who wrote the French lyrics to “O Canada”?
- Q3. In what year were the English lyrics written?

ANTICIPATED ANSWERS

- A1. 1 July 1980.
- A2. Sir Adolphe-Basile Routhier.
- A3. 1908.

Teaching Point 3

Time: 7 min

Discuss the Canadian Coat of Arms

Method: Activity/Interactive Lecture

BACKGROUND

His Majesty King George V appointed the Canadian Coat of Arms to Canada in the court of Buckingham Palace on 21 November 1921.



Canadian Heritage Website, www.canadianheritage.gc.ca

Figure 1-1-8 The Canadian Coat of Arms

DESCRIPTION OF THE ARMS

The Shield

The shield represents Canada's origins by depicting the three royal lions of England, the royal lion of Scotland, the royal fleur-de-lis of France, and the royal Irish harp of Tara. All of these nations played an integral roll in the settlement of Canada. At the base of the shield is a sprig of three Canadian maple leaves that represent Canadians of all origins.



Canadian Heritage Website, www.canadianheritage.gc.ca

Figure 1-1-9 The Shield

The Ribbon

The ribbon was added to the Canadian Coat of Arms on 12 July 1994. It contains the motto of the Order of Canada, which in Latin reads: "Desiderantes Meliorem Patriam." This translates to "They desire a better country" in English.



Canadian Heritage Website, www.canadianheritage.gc.ca

Figure 1-1-10 The Ribbon

The Crest

The crest consists of a wreath made of twisted red and white silk. On top of the wreath stands a crowned gold lion holding a red maple leaf in its right paw. The lion is a symbol of valour and courage. The crest is used to mark the sovereignty of Canada.



Canadian Heritage Website, www.canadianheritage.gc.ca

Figure 1-1-11 The Crest

The Supporters

The supporters are depicted on either side of the shield. A lion is on the shield's right holding a gold pointed silver lance from which flies the Royal Union Flag. A unicorn is on the shield's left holding a lance flying the banner of royalist France. The two banners represent the two principle founding nations that established Canada's laws and customs.



Canadian Heritage Website, www.canadianheritage.gc.ca

Figure 1-1-12 The Supporters

The Motto

The motto reads: *A mari usque ad mare* (From Sea to Sea). It was first used in 1906 during a sitting in the Legislative Assembly of Saskatchewan. It was proposed to be the new motto of the Coat of Arms and became official when the Arms was proclaimed in 1921.



Canadian Heritage Website, www.canadianheritage.gc.ca

Figure 1-1-13 The Motto

The Four Floral Emblems

The four floral emblems are the English rose, the Scottish thistle, the Irish shamrock, and the French fleur-de-lis. They are located at the base of the Arms and are associated with the Canadian Monarchy.



Canadian Heritage Website, www.canadianheritage.gc.ca

Figure 1-1-14 The Four Floral Emblems

The Imperial Crown

The imperial crown sits at the top of the Canadian Coat of Arms and indicates the presence of a monarch as Canada's head of state.



Canadian Heritage Website, www.canadianheritage.gc.ca

Figure 1-1-15 The Imperial Crown

The Canadian Coat of Arms can be recognized as the Cadet Chief Petty Officer 1st Class/Cadet Chief Warrant Officer/Cadet Warrant Officer 1st Class rank badge.

ACTIVITY

Time: 3 min

OBJECTIVE

Confirm the material delivered in TP3 by completing puzzles of the Canadian Coat of Arms.

RESOURCES

- Cut outs of the different pieces of the Canadian Coat of Arms found in [Annex A](#).
- Envelopes.

ACTIVITY LAYOUT

- Prepare four to five envelopes containing cut out pieces of the Canadian Coat of Arms found at [Annex A](#).
- Have a large picture or OHP transparency of the Coat of Arms posted in the classroom where all can easily see it.
- Divide cadets into four to five small groups.
- Hand out one envelope per group.
- Using the large picture of the arms as a guide, have cadets build the Canadian Coat of Arms in their groups using the pieces provided in the envelopes.
- When groups are complete, confirm that the Coat of Arms is pieced together correctly.

SAFETY

N/A.

INSTRUCTOR GUIDELINES

- Supervise this activity effectively.
 - Ensure activity is completed in a timely manner.
-

CONFIRMATION OF TEACHING POINT 3

QUESTIONS

- Q1. The supporters are two different animals. Which ones are they?
- Q2. On what date was the Canadian Coat of Arms proclaimed?
- Q3. The shield depicts four nations that played a large roll in the settlement of Canada. Which nations are they?

ANTICIPATED ANSWERS

- A1. A lion and a unicorn.
- A2. 21 November 1921.

A3. England, Scotland, France and Ireland.

Teaching Point 4

Discuss the Maple Leaf

Time: 2 min

Method: Interactive Lecture

THE CANADIAN MAPLE LEAF

The maple leaf began to serve as a Canadian symbol as early as 1700. In August 1860, the leaf was adopted as the national emblem of Canada for use as decorations during a visit by the Prince of Wales. During confederation in 1867, Toronto schoolmaster Alexander Muir composed *The Maple Leaf Forever* as Canada's confederation song. Many regiments during both World War I and II adorned uniforms with the maple leaf while over seas. The maple leaf was incorporated into The National Flag of Canada in 1965.



Canadian Heritage Website, www.canadianheritage.gc.ca

Figure 1-1-16 The Maple Leaf

CONFIRMATION OF TEACHING POINT 4

QUESTIONS

- Q1. When was the maple leaf first adopted as a Canadian symbol?
- Q2. What is the title of Canada's confederation song?
- Q3. The maple leaf was incorporated into what other Canadian symbol in 1965?

ANTICIPATED ANSWERS

- A1. August 1860 for a visit by the Prince of Wales.
- A2. *The Maple Leaf Forever.*
- A3. The National Flag of Canada.

END OF LESSON CONFIRMATION

ACTIVITY

Time: 3 min

OBJECTIVE

Give the cadets the opportunity to make their own Canadian symbols.

RESOURCES

- Pre-cut circles of yellow bristol board (resembling large coins) for each cadet.
- Markers or pencil crayons.

ACTIVITY LAYOUT

- Prior to the lesson, cut out circles of yellow bristol board approximately 10 cm in diameter for each cadet.
- Have markers and pencil crayons ready for the activity.
- Hand out a yellow circle of bristol board to each cadet.
- Explain cadets that they now have the opportunity to create their own Canadian symbol in the form of a coin.
- Cadets may use the symbols discussed in the lesson or symbols they feel are uniquely Canadian.
- If there is insufficient time to complete the coin activity, cadets may finish in their spare time.
- Coins can be posted in flight classrooms when complete.

SAFETY

N/A.

INSTRUCTOR GUIDELINES

- Cadets may complete the coins in their own time if time does not allow for the completion.
- **Teaching points may be confirmed orally.**

QUESTIONS

- Q1. What are the two official colours of Canada?
- Q2. What is the English meaning of "A mari usque ad mare?"
- Q3. What flag was used prior to the adoption of the current national flag?
- Q4. What language was our national anthem first written in?
- Q5. What does the imperial crown represent in the Canadian Coat of Arms?

ANTICIPATED ANSWERS

- A1. Red and white.

- A2. "From Sea to Sea."
- A3. The Canadian Red Ensign.
- A4. French.
- A5. The presence of a monarch as Canada's head of state.

CONCLUSION

HOMEWORK/READING/PRACTICE

Cadets may use their spare time to complete the coin activity.

METHOD OF EVALUATION

There is no formal assessment of this EO.

CLOSING STATEMENT

Identifying Canadian symbols is an important aspect of being a Canadian citizen and a member of the Canadian Cadet Movement. Cadets should be able to easily recognize Canadian symbols in the community and at the corps/squadron.

INSTRUCTOR NOTES/REMARKS

N/A.

REFERENCES

- C0-012 Government of Canada. (1995). *Symbols of Canada*. Ottawa: ON.
- C0-013 *Canadian Heritage Website*. (2006). Retrieved 16 March 2006, from <http://www.canadianheritage.gc.ca>.



COMMON TRAINING INSTRUCTIONAL GUIDE



SECTION 2

EO C101.02 – WATCH *HISTORICA MINUTES* VIDEOS

Total Time: 30 min

INTRODUCTION

PRE-LESSON INSTRUCTIONS

A complete list of resources needed for the instruction of this EO is located at Chapter 2 of the QSP. Specific uses for said stores are identified throughout the Instructional Guide, within the teaching point for which they are required.

Prior to instructing this lesson the instructor shall:

- review the lesson content, and become familiar with the material;
- watch the *Historica Minutes* videos as listed; and
- set up audio/visual equipment.

PRE-LESSON ASSIGNMENT

N/A.

APPROACH

The small group activity was selected to allow for maximum participation in the learning process. It is an interactive way to illustrate and substantiate the lesson material in a concrete manner.

The group discussion method was chosen to allow the cadets to share their knowledge, opinions, and feelings about the subject matter while still allowing the instructor to control the direction of the discussion. The instructor must ensure that points not brought forth by the class are presented. If the instructor follows the Instructional Guide, including the questions posed, this will allow the cadets to express, in their own words, what they learned from this lesson and how they may apply the information.

REVIEW

N/A.

OBJECTIVES

By the end of this lesson the cadet shall be expected to have participated in a discussion on *Historica Minutes* videos that relate to significant Canadian symbols/figures/events.

IMPORTANCE

Gaining an awareness of and an appreciation for history and what makes them uniquely Canadian can foster a sense of pride and citizenship in cadets.

BACKGROUND KNOWLEDGE



This background information is provided for the instructor's reference only. Cadets are not required to learn this information.

WINNIE THE POOH

While en route to France during World War I, members of The Fort Garry Horse Canadian regiment of cavalry discovered Winnipeg a bear in White River, Ontario. The bear was smuggled to Britain as the unofficial regimental mascot. Affectionately named Winnie, the bear's first owner was Lt. Harry Colebourn. Winnie's eventual destination was to be the Assiniboine Park Zoo in Winnipeg. However, at the end of the War, the officers of the Fort Garry Horse decided to allow her to remain in the London Zoo, where she was much loved for her playfulness. She was known as a kind bear and never attacked. British author A.A. Milne and his young son, Christopher Robin, saw Winnipeg at the London Zoo. She inspired Milne to create and write about the popular character, Winnie the Pooh.

INUKSHUK

An inukshuk (Inuktitut: *inuksuk*, plural *inuksuit*) is a stone landmark used as a milestone or directional marker by the Inuit of the Canadian Arctic. The Arctic Circle, dominated by permafrost, has few natural land marks and thus the inukshuk was central to navigation across the barren tundra.

Inuksuit vary in shape and size, and serve a variety of purposes. It is a symbol with deep roots in the Inuit culture, a directional marker that signifies safety, hope and friendship. The word *inuksuk* means "something which acts for or performs the function of a man."

An inukshuk is shown on the flag and Coat of Arms of the Canadian territory of Nunavut. An inukshuk forms the basis of the logo of the 2010 Vancouver Winter Olympics.

MAPLE SYRUP

Canada produces more than three-quarters of the world's maple syrup, with more than 1000 maple syrup producers using nearly 34 000 000 taps. The province of Quebec is by far the world's largest producer of maple syrup, producing more than 15 000 000 litres annually. The provinces of Ontario and New Brunswick produce much smaller amounts, about 1 000 000 litres and 700 000 litres respectively. Nova Scotia also produces a small amount of syrup. Most maple trees can be used as a source of sap, but the sugar maple and black maple are the most favored. A maple syrup production farm is called a *sugarbush* or the *sugarwoods*. Sap is boiled in a "sugar shanty", "sugar shack", "sugarhouse" or "*cabane à sucre*".

North America's native peoples discovered how to make maple syrup from the sap of maple trees centuries ago. They relied on loaves of maple sugar for energy during the winter months when other food items were scarce. Settlers also enjoyed maple sugar as a sweet treat that was carefully rationed.

Maple syrup is harvested by tapping a maple tree and then letting the sap run into a bucket. Production is concentrated in February, March and April, depending on local weather conditions. To make the syrup, holes are bored into the maple trees and hollow tubes termed *spiles* or *spouts* are inserted. These drip the sap into

buckets or into plastic pipes. A new hole must be drilled each year, as the old hole will produce sap for only one season due to the natural healing process of the tree. It takes approximately 40 litres of sap to make one litre of maple syrup, and a mature sugar maple produces about 40 litres (10 gallons) of sap during the four- to six-week sugaring season.

BLUENOSE

The *Bluenose* was a Canadian schooner from Nova Scotia, a celebrated racing ship and a symbol of the province. *Bluenose* was launched at Lunenburg, Nova Scotia on March 26, 1921, as both a working cod-fishing schooner and a racing ship. During the next 17 years of racing, no challenger could beat her.

After World War II, the undefeated *Bluenose* was sold to work as a freighter in the West Indies. She foundered on a Haitian reef on January 28, 1946.

Bluenose has adorned the Canadian dime since 1937, has been portrayed on a postage stamp, and appears on the current Nova Scotia licence plate.

Her daughter, *Bluenose II*, was launched at Lunenburg on July 24, 1963. She serves as a goodwill ambassador, tourist attraction in Lunenburg, and symbol of the province.

AVRO ARROW

The CF-105 Arrow was a delta-wing interceptor aircraft, designed and built in Malton, Ontario, by Avro Canada during the late 1950s. The design was entering the middle stages of testing when it was cancelled in 1959. The prototypes and blueprints were then destroyed.

The flight requirements for the design of the Arrow included:

- a range of 300 nautical miles (556 km) for a normal low-speed mission;
- a range of 200 nautical miles (370 km) for a high-speed interception mission;
- speed of Mach 1.5;
- cruise at an altitude of 50 000 feet (15 000 m);
- ability to pull 2 g in maneuvers with no loss of speed or altitude; and
- ability to climb to 50 000 feet (15 000 m) and reach Mach 1.5 from engine start in less than five minutes.

The rollout of the first prototype, RL-201, took place October 4, 1957, the same day the Russians launched the first satellite, Sputnik 1. RL-201 first flew on March 25, 1958. Four more Arrows were delivered in the next two years. The plane demonstrated excellent handling at all extremes of the flight envelope. The aircraft achieved a speed of over 1000 miles per hour at 50 000 feet, while climbing and still accelerating. A top speed of Mach 1.98 would eventually be reached at three quarters throttle.

The Mark 2 version was to be fitted with the Iroquois engine. At the time of cancellation of the entire program, the first Arrow Mk.2, RL-206, was nearly complete. It was expected to break the world speed record but never had the chance.

On February 20, 1959, Prime Minister Diefenbaker announced to the Canadian House of Commons that the Arrow and Iroquois programs were to be immediately cancelled, due to various economic, political and technological reasons. Within two months, all aircraft and engines, production tooling and technical data were ordered scrapped.

ACTIVITY

Time: 27 min

OBJECTIVE

This activity will expose cadets to short videos that highlight significant Canadian symbols, figures and events. The videos serve as discussion points to draw out further examples.

RESOURCES

- Audio/visual equipment.
- *Historica Minutes* videos.
- Flipchart or whiteboard.
- Markers.

ACTIVITY LAYOUT

1. Show each video:
 - Video 1 #33 Winnie;
 - Video 2 #6 Syrup;
 - Video 3 #44 Inukshuk; and
 - Video 4 #47 Bluenose and Video 5 #54 Avro Arrow (show together) (#s refer to the *Historica Minutes* video number).
2. Follow each video with a five-minute discussion, using the questions provided in the Reflection section as a guide.

SAFETY

N/A.

INSTRUCTOR GUIDELINES

- Ensure the cadets are paying attention to the videos.
- Encourage participation from all cadets.
- Record discussion answers on flipchart or whiteboard.

REFLECTION

Method: Group Discussion

GROUP DISCUSSION



Instructors shall ensure that all lesson objectives are drawn out towards the end of the reflection stage.

DISCUSSION QUESTIONS



TIPS FOR ANSWERING/FACILITATING DISCUSSION

- Ask questions that help facilitate discussion; in other words, avoid questions with yes or no answers.
- Prepare questions ahead of time.
- Be flexible (you are not bound to only the prepared questions).
- Encourage cadets to participate by using praise such as “great idea” or “excellent response, can anyone add to that?”.
- Try to involve everyone by directing questions to non-participants.

SUGGESTED QUESTIONS

VIDEO 1 – WINNIE

Q1. What other famous Canadian mascots are there?

Q2. What other animals are Canadian symbols?

VIDEO 2 – SYRUP

Q1. Have you ever made or had fresh maple syrup? Tell the class about the experience.

Q2. What other foods are uniquely Canadian?

Q3. Have you ever seen maple syrup at an airport gift shop or a souvenir shop? What other Canadian souvenirs have you seen there? What makes those things symbolic of Canada?

VIDEO 3 – INUKSHUK

Q1. Have you ever seen an inukshuk? Real or pictures? Where have you seen inuksuit?

Q2. What do you know about inuksuit?

Q3. What other buildings or structures can be recognized as representative of Canada?

VIDEO 4/5 – BLUENOSE/AVRO ARROW

Q1. What other technologies are recognized as being Canadian in origin, or associated with Canada?

CONCLUSION

HOMEWORK/READING/PRACTICE

N/A.

METHOD OF EVALUATION

There is no formal assessment of this lesson.

CLOSING STATEMENT

There are many items that are uniquely Canadian or commonly associated with Canada. Becoming aware of these items and their background can develop an awareness and appreciation for history and what makes us uniquely Canadian.

INSTRUCTOR NOTES/REMARKS

N/A.

REFERENCES

- C3-030 Historica Foundation of Canada. (n.d.) *Historica Minutes*. Toronto: ON.
- C3-031 Winnie the Pooh (2006). Retrieved 5 May 2006, from http://en.wikipedia.org/wiki/Winnie_the_pooh.
- C3-032 Inukshuk (2006). Retrieved 5 May 2006, from <http://en.wikipedia.org/wiki/inukshuk>.
- C3-033 Maple Syrup (2006). Retrieved 5 May 2006, from http://en.wikipedia.org/wiki/Maple_syrup.
- C3-034 Bluenose (2006). Retrieved 5 May 2006, from http://en.wikipedia.org/wiki/Blue_nose.
- C3-035 Avro Arrow (2006). Retrieved 5 May 2006, from http://en.wikipedia.org/wiki/Avro_arrow.

THE CANADIAN COAT OF ARMS



THIS PAGE INTENTIONALLY LEFT BLANK

CHAPTER 2
PO 102 – PERFORM COMMUNITY SERVICE



COMMON TRAINING INSTRUCTIONAL GUIDE



SECTION 1

EO M102.01 – PERFORM COMMUNITY SERVICE

Total Time:

270 min

INTRODUCTION

PRE-LESSON INSTRUCTIONS

The instructor shall review the lesson content, and become familiar with material prior to delivery of this lesson.

The choice of activity to be left to the discretion of the squadron Commanding Officer (CO).

This activity should be conducted in one day session (270 minutes) or over three separate sessions of three periods (90 minutes) each.

The use of a guest speaker would provide an opportunity for the cadets to meet and hear from a representative of a service group. Using a guest speaker as a Subject Matter Expert (SME) will provide an experienced view on, and promote interest in, the topic. The guest speaker should be briefed on the main teaching points of the lesson, so as to keep the briefing on topic. If a guest speaker is unavailable, the instructor should attempt to procure as much information as possible on the selected activity from the service group.

A complete list of resources needed for the instruction of this EO is located at Chapter 4 of the QSP. Specific uses for said stores are identified throughout the Instructional Guide, within the teaching point for which they are required.

Debriefing of the activity must be done as soon as possible following the activity.

PRE-LESSON ASSIGNMENT

N/A.

APPROACH

This lesson will be presented using the experiential method. The experiential method was chosen to allow cadets to develop knowledge and skills through a process whereby concepts are derived from, and continuously modified by, their own experience. The experiential method combines a short initial activity briefing, a structured or semi-structured activity, and a reflective group discussion. The instructor supervises the activity and then leads a group discussion to draw out reflection and connections between the experience and future applications of the learning outcomes. This method appeals to tactile/kinaesthetic learners.

REVIEW

N/A.

OBJECTIVES

By the end of this lesson the cadet shall experience the benefits of volunteerism, and the impact volunteerism has on the cadet and the community.

IMPORTANCE

One of the aims of the CCM is to develop in youth the “attributes of good citizenship”. To that end, good citizenship is defined as “actively and purposely participating in your community”.

BACKGROUND KNOWLEDGE

COMMUNITY SERVICE DEFINED:

Work, especially voluntary and unpaid, or stipulated by a community service order in the community (*The Concise Oxford Dictionary – ninth edition*).

Voluntary Done, acting, or able to act on one’s own free will, not constrained or compulsory (*The Concise Oxford Dictionary – ninth edition*).

Cadet Definition. Actively and purposefully participating in the community.

SERVICE GROUPS:

THE ROYAL CANADIAN LEGION

By the end of WWI there were a total of 15 veterans’ groups and a number of regimental associations representing former service members in Canada. Despite their common goal of helping returned servicemen in need, their efforts were fragmented and largely unsuccessful. In 1925, an appeal for unity leads to the formation of the Dominion Veterans Alliance, out of which evolved The Canadian Legion of the British Empire Services League the following year.

WWII brought an influx of new demands. The Legion provided canteens, entertainment and reading material for those serving abroad and at home, as well as correspondence courses to help them out on their return to civilian life. But most importantly, from the onset of war, the Legion began to prepare for the returning troops. Financial compensation, clothing allowances, pensions, medical treatment, preference in the civil service, vocational training and land settlements were all routinely arranged and provided. To this day the Legion maintains a nation-wide network of professionals helping veterans, ex-service members and their families to secure the pensions and benefits to which they are entitled.

Although the Legion was founded to advance the cause of veterans, its grass-roots structure led naturally to community service. Almost every Legion branch in Canada is involved in one or more youth programs. It may be sponsoring a local hockey team, a cadet squadron or a scout troop. It may be sponsoring youth leadership training or other programs that meet the needs of youth in the community. The Legion wants Canadian youth to know that the freedoms they enjoy did not come without a price. The Legion supports the cadet movement in Canada to promote leadership, fitness and the spirit of patriotism. It also supports the Legion Medal of Excellence, which many branches and commands provide to honour outstanding cadets.

Today, with over 450 000 members, The Royal Canadian Legion is the largest veterans-based community service organization in the country, contributing millions of dollars and voluntary hours to help Canadians, particularly veterans, seniors and youth. Most Canadians associate the Legion with remembrance ceremonies and activities perpetuating the memory of those who died in the two world wars and the Korean War. Probably the most widely known activity is the National Poppy Remembrance Campaign in which Legion members, friends and cadets distribute poppy emblems for donations to raise money for needy veterans, ex-service members and their families.

LIONS CLUB

Since 1917, Lions have served the world's population through hard work and commitment to make a difference in the lives of people everywhere. With 1 436 487 members serving in more than 44 500 clubs in over 180 countries and areas, Lions Clubs International is the world's largest service club organization. Canada alone has over 1900 clubs and over 49 000 members. Lions are recognized worldwide for their service to the blind and visually impaired. The club motto is "We Serve."

Lions International objectives:

- To create and foster a spirit of understanding among the peoples of the world.
- To promote the principle of good government and good citizenship.
- To take an active interest in the civic, cultural, social and moral welfare of the community.
- To unite the clubs in the bonds of friendship, good fellowship and mutual understanding.
- To provide a forum for the open discussion of all matters of public interest; provided, however, that club members should not debate partisan politics and sectarian religion.
- To encourage service-minded people to serve their community without personal financial reward, and to encourage efficiency and promote high ethical standards in commerce, industry, professions, public works and private endeavours.

ROTARY CLUB

Founded in 1905, by Chicago Lawyer Paul Harris and three business acquaintances, Rotary International is a worldwide organization of more than 1.2 million members, in more than 29 400 clubs in 160 nations. The objective of the Rotary Club is to encourage and foster the ideal of service as a basis of worthy enterprise and, in particular, to encourage and foster:

- the development of acquaintances as an opportunity for service;
- high ethical standards of business and profession; the recognition of the worthiness of all useful occupations; and the dignifying by each Rotarian of their occupation as an opportunity to serve society;
- the application of the ideal of service by every Rotarian to their personal business and community life; and
- the advancement of international understanding, goodwill and peace, through a world fellowship of business and professional persons united in the ideal of service.

A good example of Rotary's work is their partnership with the World Health Organization and the United Nations to immunize all the children of the world against poliomyelitis – the wild poliovirus. To date, a million volunteers mobilized by Rotary have immunized a billion children throughout the developing world. The goal of the Polio Plus campaign was to certify the eradication of polio by the year 2005 – Rotary's 100th anniversary. In 2005, Rotarians and partners celebrated the tremendous progress made towards polio eradication.

KIWANIS CLUB

The first Kiwanis club was organized in Detroit, Michigan, USA on January 21, 1915. A year later the Kiwanis Club of Hamilton, Ontario, Canada, was chartered, and Kiwanis International grew rapidly into a leading service club in these two founding nations. In 1962, worldwide expansion was approved, and today Kiwanis clubs are active in every part of the world. The club motto is "We Build." There are more than 8500 Kiwanis clubs with more than 315 000 members in 82 nations and geographic areas.

Kiwanis' continuing service emphasis is called "Young Children: Priority One," which focuses on the special needs of children from prenatal development to age 5. Projects conducted as part of the "Young Children: Priority One" service emphasis involved \$14.3 million and 1.3 million volunteer hours.

In 1994, Kiwanis launched its first Worldwide Service Project, a \$75 million campaign in partnership with UNICEF to eliminate Iodine Deficiency Disorders (IDDs) by the year 2000. IDD is rare in areas where iodized salt is used, but in other parts of the world, IDD is the leading cause of preventable mental and physical retardation. As many as 1.5 billion people are at risk, especially young children. In 2000, \$62 million was raised, and the goal of \$75 was surpassed in 2001.

THE UNITED WAY

The United Way is a non-profit organization that works in partnership with community agencies and organizations. By bringing groups together to share experience and expertise, the United Way is working with others to improve community life. Each year the United Way collects millions of dollars needed for essential health and social services and programs. The money is carefully distributed to meet the greatest need in our community and a rigorous review process ensures that the money is spent effectively.

BOYS AND GIRLS CLUB

The boys and girls club enhances the quality of life for children and youth by providing a safe and welcoming environment. It offers supervised activities, support and counselling for young people aged 6 to 18 years old. They also provide a social service for "at risk youth," and youth with special needs.

ACTIVITY

Time: 270 min

Method: Experiential

OBJECTIVE

The group being assisted will define the objective of the activity.

RESOURCES

There is no specific resource support for this activity. The local group being assisted should provide the necessary materials.

ACTIVITY LAYOUT

- The cadets are to receive a briefing prior to the start of the activity, which may be given by a guest speaker from the community group being assisted, to include an explanation of:
 - the objectives of the activity;
 - resources required;
 - set-up of the activity; and
 - safety guidelines while performing the activity (as required).
- Cadets will participate in the activity, under supervision (activity to be determined by the CO).
- The cadets are to be debriefed on their participation in the activity immediately following the activity.

SAFETY

At this point the instructor shall brief the cadets on any safety rules or regulations regarding the activity.

INSTRUCTIONAL GUIDELINES

During the activity the instructor should make observations on the cadets to include:

- How did the cadets react to the activity?
- What area did they appear to enjoy most/least?



Observation of the activity is important so that proper questions can be developed for the reflective stage.

REFLECTION

Time: 30 min

Method: Group Discussion

GROUP DISCUSSION



The instructor shall ensure that all lesson objectives are covered toward the end of the reflection stage.



TIPS FOR ANSWERING/FACILITATING DISCUSSION

- Ask questions that help facilitate discussion; in other words, avoid questions with yes or no answers.
- Prepare questions ahead of time.
- Be flexible (you are not bound to only the prepared questions).
- Encourage cadets to participate by using praise such as “great idea” or “excellent response, can anyone add to that?”.
- Try to involve everyone by directing questions to non-participants.

SUGGESTED QUESTIONS

- Q1. How did they feel about the activity?
- Q2. What did they feel they accomplished?
- Q3. What benefit did the community received from their participation?
- Q4. In what other ways can a cadet be a more active citizen based on this activity?



Other questions and answers will develop throughout the reflection stage. The discussion should not be limited to only those suggested.

CONCLUSION

REVIEW

Upon completion of the discussion, the instructor will conclude by summarizing the aim of participating in the activity and allow cadets to reflect upon it. The instructor must also take this opportunity to explain how the cadet could apply this knowledge and/or skill in the future.

MAIN TEACHING POINTS

N/A.

HOMEWORK/READING/PRACTICE

N/A.

METHOD OF EVALUATION

There is no formal assessment of this EO. The instructor will confirm the cadets' comprehension of the material prior to beginning the actual activity, and immediately afterwards, by means of a debrief.

CLOSING STATEMENT

The Canadian Cadet Movement strives to develop in youth the attributes of good citizenship. Actively participating in the community provides a cadet with the chance to assist members of the community, thus demonstrating those same attributes. Cadets are encouraged to seek out additional, more personal, ways to be assist in the community.

INSTRUCTOR NOTES/REMARKS

N/A.

REFERENCES

- C0-014 The Royal Canadian Legion. (2002). *The Royal Canadian Legion: Responding to the Needs of Canadian Communities*. Retrieved 25 May 2006, from http://www.legion.ca/asp/docs/about/community_e.asp.
- C0-015 Kiwanis International. (2006). *About Kiwanis*. Retrieved 25 May 2006, from <http://www.kiwanis.org/about>.
- C0-016 Lions Club International. (2006). *Lions Clubs International History*. Retrieved 25 May 2006, from http://www.lionsclubs.org/en/content/lions_history.shtml.
- C0-017 Rotary International. (2005). *About Rotary*. Retrieved 25 May 2006, from <http://www.rotary.org/aboutrotary/index.html>.
- C0-044 UNESCO. (2006). *Canadian Commission for UNESCO*. Retrieved 16 August 2006, from <http://www.unesco.ca>.



COMMON TRAINING INSTRUCTIONAL GUIDE



SECTION 2

EO C102.01 – PARTICIPATE IN A CEREMONIAL PARADE

Total Time:

90 min

INTRODUCTION

PRE-LESSON INSTRUCTIONS

The instructor shall review the lesson content, and become familiar with the material prior to instruction of this lesson.

PRE-LESSON ASSIGNMENT

N/A.

APPROACH

This lesson will be presented using the experiential method. The experiential method was chosen to allow cadets to develop knowledge and skills through a process whereby concepts are derived from, and continuously modified by, their own experience. The experiential method combines a short initial activity briefing, a structured or semi-structured activity, and a reflective group discussion. The instructor supervises the activity and then leads a group discussion to draw out reflection and connections between the experience and future applications of the learning outcomes. This method appeals to tactile/kinaesthetic learners.

REVIEW

N/A.

OBJECTIVES

By the end of the lesson, the cadet shall be expected to participate in a ceremonial parade.

IMPORTANCE

It is important to participate in ceremonial parades to promote an interest in the Canadian Forces (CF), while simultaneously serving a role in the community. Ceremonial parades are a large part of Canada's military past, and provide a direct link to the community. It is important for cadets to fully appreciate the relationships between the squadron and the community in which they live.

BACKGROUND KNOWLEDGE



Instructors should familiarize themselves with the appropriate background information for the parades in which they will participate.

REMEMBRANCE DAY OBSERVANCES

Every 11th of November Remembrance Day is held to commemorate Canadians who died in the First and Second World Wars and the Korean War. The first Remembrance Day, originally called Armistice Day, was conducted throughout the Commonwealth in 1919. The day commemorated the end of the First World War, on Monday, November 11, 1918 at 11 a.m., the eleventh hour of the eleventh day of the eleventh month. The symbol of Remembrance Day is the poppy, popularized by LCol John McCrae's poem *In Flanders Fields*.

BATTLE OF THE ATLANTIC (NAVY)

The Battle of the Atlantic began September 3, 1939 with the sinking of the Montreal-bound passenger ship SS Athenia by a German submarine west of Ireland. One hundred and eighteen passengers and crew were killed, including four Canadians. Escort of merchant ship convoys was the RCN's chief responsibility during the Battle. The first convoy sailed from Halifax on September 16, 1939. The Royal Canadian Navy (RCN) began the war with 13 vessels and 3500 personnel, and ended the war with the third largest navy in the world. Of the 110 000 members at the end of the war, all of whom were volunteers, 6500 were women who served in the Women's Royal Canadian Naval Services. The Battle of the Atlantic was considered to be won by the Allies in 1943, although this battle lasted the duration of the Second World War that, in Europe, ended May 8, 1945. The Battle of the Atlantic is celebrated on the first Sunday in May.

BATTLE OF BRITAIN (AIR)

The Battle of Britain parade is held in September each year to commemorate the Battle of Britain and honour the members of the Air Force who died in this battle and others. The Battle of Britain was entirely an air battle and was one of the most decisive battles in all history. During the autumn of 1940, the Commonwealth Air Forces defeated the German Luftwaffe. It is believed that Great Britain would have been invaded had the Battle of Britain been lost. The Royal Canadian Air Force is proud of the active part it played in the historic battle.

ACTIVITY

Time: 60 min

Method: Experiential

OBJECTIVE

Participate in a ceremonial parade.

RESOURCES

- Properly maintained uniform.
- Ceremonial webbing and accoutrements (as required).
- Any other material required in the execution of the cadets role in the parade.

ACTIVITY LAYOUT

- Briefing on the activity by the instructor/guest speaker.
- Cadet participation in the activity.
- Cadet debrief.

SAFETY

- Cadets are to respect all established boundaries.
- Cadets shall travel in groups of no less than two, utilizing the “Buddy System” to ensure a cadet is never alone at any point.
- Cadets shall assemble at previously assigned meeting points, at the times detailed in order to ensure effective headcounts may be carried out, and new information may be relayed.

INSTRUCTIONAL GUIDELINES



At this point the instructor shall brief the cadets on any safety rules or other guidelines pertaining the activity. Specifics are to be provided by the event organizer and relayed to the cadets by the instructor in a timely fashion.



The instructor or guest speaker shall ensure that the following lesson objectives are covered during the activity:

- An explanation of the objectives of the parade and why it is important.
- An explanation of the sequence of events, and their roles during the event.

The instructor will make sure that all cadets know their role for the parade. The instructor will supervise and advise, providing direction and making corrections as necessary.

REFLECTION

Time: 20 min

Method: Group Discussion

GROUP DISCUSSION



Instructors shall ensure that all lesson objectives are drawn out towards the end of the reflection stage.

DISCUSSION QUESTIONS



TIPS FOR ANSWERING/FACILITATING DISCUSSION

- Ask questions that help facilitate discussion; in other words, avoid questions with yes or no answers.
- Prepare questions ahead of time.
- Be flexible (you are not bound to only the prepared questions).
- Encourage cadets to participate by using praise such as “great idea” or “excellent response, can anyone add to that?”.
- Try to involve everyone by directing questions to non-participants.

Questions will vary based on the ceremonial parade chosen by the squadron and element.

SUGGESTED QUESTIONS

- Q1. How did you feel about the parade?
- Q2. What do you feel you accomplished?
- Q3. What does your participation in the parade represent?
- Q4. What are some ways that cadets can be more active citizens based on this experience?



Other questions and answers will develop throughout the reflection stage. The discussion should not be limited to only those suggested.

CONCLUSION

REVIEW

Upon completion of the group discussion the instructor will conclude by summarizing to ensure that all teaching points have been covered. The instructor must also take this opportunity to explain how the cadet will apply this knowledge and/or skill in the future.

MAIN TEACHING POINTS

N/A.

HOMEWORK/READING/PRACTICE

N/A.

METHOD OF EVALUATION

N/A.

CLOSING STATEMENT

Cadets should feel pride in participating in a ceremonial parade and filling the various roles. Ceremonial parades allow the cadets to gain some insight into a formal parade, and to fill a role within the community.

INSTRUCTOR NOTES/REMARKS

N/A.

REFERENCES

- C0-051 Veteran's Affairs Canada. (1999). *VAC Canada Remembers: Facts on Remembrance Day*. Retrieved 25 May 2006, from http://www.vac_acc.gc.ca/remembers/sub.cfm?source=teach_resources/remdayfact.
- C0-052 Veteran's Affairs Canada. (28 April 2003). *The Battle of the Atlantic*. Retrieved 25 May 2006, from www.vac-acc.gc.ca/general/sub.cfm?source=history/secondwar/atlantic/atlfact.

THIS PAGE INTENTIONALLY LEFT BLANK



COMMON TRAINING INSTRUCTIONAL GUIDE



SECTION 3

EO C102.02 – PERFORM COMMUNITY SERVICE

Total Time:

270 min

INTRODUCTION

PRE-LESSON INSTRUCTIONS

The instructor shall review the lesson content, and become familiar with the material prior to instruction of this lesson.

A complete list of resources needed for the instruction of this EO is located at Chapter 4 of the QSP. Specific uses for said stores are identified throughout the Instructional Guide, within the teaching point for which they are required.

The choice of activity is to be left to the discretion of the squadron Commanding Officer (CO).

This activity should be conducted in a day or three sessions of three periods each (270 min).

The use of a guest speaker provides an opportunity for the cadets to meet and hear from a representative of a service group. Using a guest speaker as a Subject Matter Expert (SME) will provide an experienced view on, and promote interest in, the topic. The guest speaker should be briefed on the objectives of the EO, to keep the briefing on topic. If a guest speaker is unavailable, the instructor should attempt to procure as much information as possible on the selected activity from the service group.

Debriefing of the activity must be done as soon as possible following the activity.

PRE-LESSON ASSIGNMENT

N/A.

APPROACH

This lesson will be presented using the experiential method. The experiential method was chosen to allow cadets to develop knowledge and skills through a process whereby concepts are derived from, and continuously modified by, their own experience. The experiential method combines a short initial activity briefing, a structured or semi-structured activity, and a reflective group discussion. The instructor supervises the activity and then leads a group discussion to draw out reflection and connections between the experience and future applications of the learning outcomes. This method appeals to tactile/kinaesthetic learners.

REVIEW

N/A.

OBJECTIVES

By the end of this lesson the cadet shall experience the benefits of volunteerism, and the impact volunteerism has on the cadet and the community.

IMPORTANCE

One of the aims of the CCM is to develop in youth the “attributes of good citizenship”. To that end, good citizenship is defined as “actively and purposely participating in your community.”

BACKGROUND KNOWLEDGE



Background information on community service activities and specific groups can be found in EO M102.01 (Section 1), and may be referenced if required.

ACTIVITY

Time: 225 min

Method: Experiential

OBJECTIVE

Perform an additional community service activity.

RESOURCES

There is no resource support for this activity. The local group being assisted should provide any necessary materials.

ACTIVITY LAYOUT

- The cadets are to receive a briefing prior to the start of the activity, which may be given by a guest speaker from the community group being assisted, to include an explanation of:
 - the objectives of the activity;
 - resources required;
 - set-up of the activity; and
 - safety guidelines while performing the activity (as required).
- Cadets will participate in the activity, under supervision (activity to be determined by the CO).
- The cadets are to be debriefed on their participation in the activity immediately following the activity.

SAFETY

The instructor shall brief the cadets on any safety rules or regulations regarding the activity being conducted.

INSTRUCTIONAL GUIDELINES

During the activity the instructor should make the following observations:

- How did the cadets react to the activity?
- What area did they appear to enjoy most?



Observation of the cadets during the conduct of the activity is important so that proper question can be developed for the reflective stage.

REFLECTION

Time: 30 min

Method: Group Discussion

GROUP DISCUSSION



The instructor shall ensure that all lesson objectives are covered towards the end of the reflection stage.



TIPS FOR ANSWERING/FACILITATING DISCUSSION

- Ask questions that help facilitate discussion; in other words, avoid questions with yes or no answers.
- Prepare questions ahead of time.
- Be flexible (you are not bound to only the prepared questions).
- Encourage cadets to participate by using praise such as “great idea” or “excellent response, can anyone add to that?”.
- Try to involve everyone by directing questions to non-participants.

SUGGESTED QUESTIONS

- Q1. How did you feel about the activity?
- Q2. What do you feel you accomplished through this activity?
- Q3. What benefit did the community received from your participation?
- Q4. In what other ways can a cadet be a more active citizen?



Other questions and answers will develop throughout the reflection stage. The discussion should not be limited to only those suggested.

CONCLUSION

REVIEW

Upon completion of the group discussion, the instructor will conclude by summarizing objectives to ensure that all there have been covered. The instructor must also take this opportunity to explain how the cadet could apply this knowledge and/or skill in the future.

MAIN TEACHING POINT

N/A.

HOMEWORK/READING/PRACTICE

N/A.

METHOD OF EVALUATION

There is no formal assessment of this EO. The instructor will confirm the cadets' comprehension of the material prior to beginning the activity, and immediately afterwards, by means of a debrief.

CLOSING STATEMENT

The CCM strives to develop in youth the attributes of good citizenship. Actively participating in the community provides a cadet with the chance to assist members of the community, thus demonstrating those same attributes. Cadets are encouraged to seek out additional, more personal ways to assist in the community.

INSTRUCTOR NOTES/REMARKS

N/A.

REFERENCES

N/A.

CHAPTER 3

PO 103 – PARTICIPATE AS A MEMBER OF A TEAM



COMMON TRAINING INSTRUCTIONAL GUIDE



SECTION 1

EO M103.01 – IDENTIFY THE RESPONSIBILITIES OF A FOLLOWER IN A TEAM

Total Time:

30 min

INTRODUCTION

PRE-LESSON INSTRUCTIONS

A complete list of resources needed for the instruction of this EO is located at Chapter 2 of the QSP. Specific uses for said stored are identified throughout the Instructional Guide, within the teaching point for which they are required.

Prior to instructing this lesson the instructor shall:

- review the lesson content, and become familiar with the material; and
- cut out the slips of paper found in [Annex A](#).

PRE-LESSON ASSIGNMENT

N/A.

APPROACH

The interactive lecture method was chosen as it allows the instructor to make a semi-formal presentation of the material where the cadets can participate by asking or responding to questions and commenting on the material. For this lesson, this method is most effective as it matches well the taxonomic level of the material and is age-appropriate by virtue of its participatory nature.

REVIEW

N/A.

OBJECTIVES

By the end of this lesson the cadet shall be expected to identify the responsibilities of a follower in a team.

IMPORTANCE

Cadets need to learn how to be effective members of a team. Understanding the responsibilities of a follower in a team setting will make cadets more aware of what is expected of them. This knowledge will enable them to contribute to the overall success of the team.

Teaching Point 1**Explain the Four Responsibilities of a Follower in a Team**

Time: 8 min

Method: Interactive Lecture

RESPECT THE LEADER AND OTHER TEAM MEMBERS

The ability to work with other people in a team is a useful skill. A sincere respect for other people is a great asset. In order to be an effective team member one must respect what the leader is asking the team to do. It is also important to respect the opinion and views of the other members of the team.

COOPERATE WITH OTHERS

In order for the team to effectively and efficiently achieve an objective the members must cooperate. Through cooperation a great deal more can be achieved than by working alone.

ADMIT MISTAKES AND LEARN FROM EXPERIENCE

In a team setting one must be able to admit when they are wrong and learn from the mistake. This will make the team stronger and create a better outcome.

ACCEPT CONSTRUCTIVE CRITICISM

Constructive criticism is observations or thoughts about ways to improve the manner in which a task was completed. Leaders will often provide constructive criticism to members of the team. This criticism is given to assist individuals develop as team member and eventually become leaders. Members must learn to take this criticism and use it in a beneficial way.

CONFIRMATION OF TEACHING POINT 1

QUESTIONS

- Q1. What is constructive criticism?
- Q2. What does it mean to admit mistakes and learn from experience?
- Q3. Why is it important to respect the leader and other team members?

ANTICIPATED ANSWERS

- A1. Constructive criticism is observations or thoughts about ways to improve the manner in which a task was completed.
- A2. In a team setting one must be able to admit when they are wrong and learn from the mistake. This will make the team stronger and create a better outcome.
- A3. The ability to work with other people in a team is a useful skill. A sincere liking and respect for other people is a great asset. In order to be an effective team member one must respect what the leader is asking the team to do. It is also important to respect the opinion and views of the other members of the team.

Teaching Point 2**Explain the Five Responsibilities of a Follower in a Team**

Time: 8 min

Method: Interactive Lecture

ASSUME RESPONSIBILITY

Team members should be prepared to assume responsibility when needed. The team leader will often delegate duties to team members and rely on these members to be prepared and willing to take on the responsibility.

BE HONEST

Team members must be honest with others in the team. Most people will believe and want to work with someone they trust. Honesty is an important characteristic of a good follower. In order to complete objectives, team members must trust each other and be honest.

ACCEPT OTHER TEAM MEMBERS FOR WHO THEY ARE

It is important to be sensitive to other people's wants and needs and to changes in these wants and needs. Acceptance and understanding of individual differences will allow the group to communicate and cooperate.

KNOW THE JOB AND BE PREPARED

A good follower needs to be knowledgeable about the group's goals. An effective follower should be organized and prepared.

COMMUNICATE CLEARLY WITH OTHERS

A follower must be able to understand and communicate with the leader and other team members. Communication works in two directions, listening and speaking. The ability to listen to others is essential in receiving correct information and implementing the strategy outlined for the team.

CONFIRMATION OF TEACHING POINT 2

QUESTIONS

- Q1. Why is it important to be honest in a team?
- Q2. What does it mean to communicate clearly with others?
- Q3. Why must a team member assume responsibility?

ANTICIPATED ANSWERS

- A1. Team members must be honest with others in the team. Most people will believe and want to work with someone they trust. Honesty is an important characteristic of a good follower. In order to complete objectives, team members must trust each other and be honest.
- A2. A follower must be able to understand and communicate with the leader and other team members. Communication works in two directions, listening and speaking. The ability to listen to others is essential in receiving correct information and implementing the strategy outlined for the team.
- A3. Team members should be prepared to assume responsibility when needed. The team leader will often delegate duties to team members and will rely on these members to be prepared and willing to take on the responsibility.

END OF LESSON CONFIRMATION

ACTIVITY

Time: 7 min

OBJECTIVE

The objective of this activity is for the cadets to unscramble the responsibilities of a follower in a team and explain what each means.

RESOURCES

- Scrambled responsibilities found in [Annex A](#).
- Container to pick scrambled responsibilities from.

ACTIVITY LAYOUT

- Divide the class into nine groups. If the class is too small, fewer groups can be formed.
- Have one member from each group pick a slip from the container.
- Each group will unscramble the words to reveal one of the responsibilities of a follower.
- The group will then discuss what the responsibility means.
- Each group will briefly present their answer to the class.

SAFETY

N/A.

INSTRUCTOR GUIDELINES

- Ensure all cadets are participating.
 - Answer any questions.
-

CONCLUSION

HOMEWORK/READING/PRACTICE

N/A.

METHOD OF EVALUATION

There is no formal assessment of this EO.

CLOSING STATEMENT

Understanding the responsibilities of a follower in a team is essential for team members. Knowing what is expected of them will help create a successful outcome.

INSTRUCTOR NOTES/REMARKS

N/A.

REFERENCES

- C3-038 Campbell, R. (2006). *Leadership: Getting It Done*. Retrieved 16 March 2006, from <http://www.ssu.missouri.edu/faculty/rcampbell/leadership/chapter5.htm>.

THIS PAGE INTENTIONALLY LEFT BLANK



COMMON TRAINING INSTRUCTIONAL GUIDE



SECTION 2

EO M103.02 – MAP PERSONAL GOALS FOR THE TRAINING YEAR

Total Time:

30 min

INTRODUCTION

PRE-LESSON INSTRUCTIONS

The instructor shall review the lesson content and become familiar with the material prior to the instruction of the lesson.

A complete list of resources needed for the instruction of this EO is located at Chapter 2 of the QSP. Specific uses for said stores are identified throughout the Instructional Guide, within the teaching point for which they are required.

PRE-LESSON ASSIGNMENT

N/A.

APPROACH

The small group activity was selected to allow for maximum participation in the learning process. It is an interactive way to illustrate and substantiate the lesson material in a concrete manner.

The group discussion method was chosen to allow the cadets to share their knowledge, opinions, and feelings about the subject matter while still allowing the instructor to control the direction of the discussion. The instructor must ensure that points not brought forth by the class are presented. If the instructor follows the Instructional Guide, including the questions posed, this will allow the cadets to express, in their own words, what they learned from this lesson and how they may apply the information.

REVIEW

N/A.

OBJECTIVES

By the end of this lesson the cadet shall be expected to:

- complete a self-esteem activity;
- complete a goal mapping activity; and
- participate in a discussion concerning personal goals for the training year.

IMPORTANCE

Individuals play an important role within a team. Personal factors such as self-esteem and self-confidence can both positively and negatively affect a team. Being familiar with tools that can strengthen both factors will benefit the individual and the team as a whole. Goal mapping is a tool that can assist cadets in planning goals for the year. The thinking and planning involved in this process allows the cadets to further build upon their self-esteem and confidence.

BACKGROUND KNOWLEDGE

SELF-ESTEEM

Self-esteem encompasses how people view themselves. This includes, but is not limited to:

- how much individuals like themselves;
- how valuable they feel they are; and
- how comfortable they are with themselves.

SELF-CONFIDENCE

Self-confidence encompasses how individuals portray themselves. It is a major factor that can influence ones ability to perform within specific situations. By having high self-esteem, a strong level of self-confidence can be developed.

GOAL MAPPING

Goal mapping is an activity that allows people to recognize their personal motivations. Setting goals that can be achieved both in the short and long terms are beneficial to both the individual and the team. The more aware people are of others, their habits and desires, the more successful they can be in creating stronger team energy.

ACTIVITY 1

Time: 5 min

OBJECTIVE

The objective of this activity is to have cadets recognize different actions that may be useful measurements of self-esteem.

RESOURCES

Self-esteem scale found in Annex B.

ACTIVITY LAYOUT

- Have the cadets complete the scale located in Annex B.
- The cadets will have three minutes to complete the activity.
- Inform the cadets that the scale is for personal use only and can be reviewed periodically throughout the year and updated accordingly.
- Inform the cadets that it can be a useful tool to monitor their self-esteem.

SAFETY

N/A.

INSTRUCTOR GUIDELINES

The self-esteem scale is used solely for the cadet as a reflection tool. The instructor **WILL NOT** call upon cadets to provide specific examples from their scales during the reflection stage. The activity is simply used to introduce the concept of self-esteem.

ACTIVITY 2

Time: 10 min

OBJECTIVE

The objective of this activity is to have cadets map out short- and long-term goals with respect to their roles and responsibilities within the cadet unit.

RESOURCES

Goal mapping exercise found in Annex C.

ACTIVITY LAYOUT

- Have the cadets write down two short-term and long-term goals that they would like to achieve with respect to their role and responsibilities within the unit. A copy of the exercise is provided in Annex C.
- The cadets will have 10 minutes to complete the activity.
- Have them write down the steps they feel they need to take to achieve each goal.
- Inform the cadets that for this exercise, short-term goals are goals they wish to achieve within three months, and long-term goals are goals they wish to achieve by the end of Level One.
- Encourage the cadets to come up with simple goals. Some examples would be maintaining and improving on the quality of their dress and deportment, or participating in a new activity at the corps/squadron.
- After the activity is complete, have the cadets put their books aside.

SAFETY

N/A.

INSTRUCTOR GUIDELINES

At this point the instructor shall brief the cadets on any other guidelines pertaining to the activity.

N/A.

REFLECTION

Time: 10 min

Method: Group Discussion

GROUP DISCUSSION



Instructors shall ensure that all lesson objectives are drawn out towards the end of the reflection stage.

DISCUSSION QUESTIONS



TIPS FOR ANSWERING/FACILITATING DISCUSSION

- Ask questions that help facilitate discussion; in other words, avoid questions with yes or no answers.
- Prepare questions ahead of time.
- Be flexible (you are not bound to only the prepared questions).
- Encourage cadets to participate by using praise such as “great idea” or “excellent response, can anyone add to that?”.
- Try to involve everyone by directing questions to non-participants.

SUGGESTED QUESTIONS

- Q1. Why are self-esteem and self-confidence important factors in effective team building and leadership?
- Q2. How can a goal mapping exercise be effective in planning short- and long-term goals?
- Q3. How can goal mapping be a useful tool with respect to effective teams and leadership?



Other questions and answers will develop throughout the reflection stage. The discussion should not be limited to only those suggested.

CONCLUSION

REVIEW

Upon completion of the group discussion conclude by summarizing to ensure that all teaching points have been covered. Take the opportunity to explain how the cadet will apply this knowledge in the future.

MAIN TEACHING POINTS

- TP1. Self-esteem and self-confidence.
- TP2. Goal mapping.

TP3. Personal goals for the training year.



Instructors shall reinforce those answers and comments discussed during reflection, but must ensure that the main teaching points have been covered. Any main teaching point not brought out during the group discussion shall be covered during review.

HOMEWORK/READING/PRACTICE

If the cadets did not have the opportunity to complete the two activities during the lesson, they are to complete them on their own time. The cadets will not be required to hand in these exercises. They are simply tools to be used by the cadets themselves.

METHOD OF EVALUATION

There is no formal assessment of this EO.

CLOSING STATEMENT

In order for a team to be successful in any task, its members need to be positive. As previously mentioned, personal factors such as self-esteem and self-confidence can both positively and negatively affect a team. Being familiar with tools that can strengthen both factors are beneficial skills both personally and collectively. By setting short- and long-term goals, cadets have something to work toward, and are thus more motivated to complete the tasks ahead.

INSTRUCTOR NOTES/REMARKS

N/A.

REFERENCES

- C0-021 Adams, B. (2001). *The Everything Leadership Book: The 20 Core Concepts Every Leader Must Know*. Avon, Massachusetts: Adams Media Corporation.
- C0-022 Cole, K. (2002). *The Complete Idiots Guide to Clear Communication*. Indianapolis, IN: Alpha Books.

THIS PAGE INTENTIONALLY LEFT BLANK



COMMON TRAINING INSTRUCTIONAL GUIDE



SECTION 3

EO M103.03 – PARTICIPATE IN TEAM BUILDING ACTIVITIES

Total Time:

60 min

INTRODUCTION

PRE-LESSON INSTRUCTIONS

A complete list of resources needed for the instruction of this EO is located at Chapter 2 of the QSP. Specific uses for said stores are identified throughout the Instructional Guide, within the teaching point for which they are required.

Prior to instructing this lesson the instructor shall:

- set up a suitable classroom space, including an Overhead Projector (OHP); and
- gather pens and paper for the group.

PRE-LESSON ASSIGNMENT

N/A.

APPROACH

The small group activity was selected to allow for maximum participation in the learning process. It is an interactive way to illustrate and substantiate the lesson material in a concrete manner.

The group discussion method was chosen to allow the cadets to share their knowledge, opinions, and feelings about the subject matter while still allowing the instructor to control the direction of the discussion. The instructor must ensure that points not brought forth by the class are presented. If the instructor follows the Instructional Guide, including the questions posed, this will allow the cadets to express, in their own words, what they learned from this lesson and how they may apply the information.

REVIEW

N/A.

OBJECTIVES

By the end of this lesson the cadet shall be expected to identify the advantages and characteristics of teamwork that will aid in developing a positive team dynamic along with improving their individual teamwork skills.

IMPORTANCE

Having the skills to work as an effective team member is essential to the success of the team. Once introduced to these skills, they will continue to develop whenever the individual is placed in a team setting or situation that require people to work together.

BACKGROUND KNOWLEDGE

CHARACTERISTICS OF A SUCCESSFUL TEAM

- **Communication.** Clear communication is essential to an effective team. Team members must feel comfortable sharing ideas and concerns with each other and the leader.
- **Mutual Cooperation and Support.** It is hard to be innovative when you are not sure how others will react to your ideas. Team members must be aware that even if people disagree the objection is to the idea, not to the person presenting it. Members of a team must have the right to a certain level of trust that precludes backstabbing, gossip, and negative behaviours aimed solely at making someone look bad.
- **Share a Common Goal.** When a team understands the purpose for a task they have a heightened motivation to work together towards the completion of it.
- **High Esprit de Corps.** When each member of the team has a sense of pride and belonging to the team, it is more likely they will want to be part of the team. This sense of belonging will enable the group to become more cohesive and willing to work together to accomplish the task.

ADVANTAGES OF EFFECTIVE TEAMWORK

- **Includes Everyone and Ensures a Better Outcome.** In a team setting people feel that their contributions are valuable. A strong group performance is generated from strong individual efforts. When many individuals are working together to accomplish a task different ideas and opinions mesh together to provide a sound outcome.
- **Tasks Are Easier When More People Are Involved.** When the responsibility and workload are shared among the team members and the team works together to ensure everyone stays on track, the team will offer support to those who need it.
- **Increases and Develops Communication.** Teamwork is an opportunity for people to interact in new ways by forming relationships and communicating with new people. Communication is the key to ensuring members are carrying out their role in accomplishing the task.

ACTIVITY 1 – THE HUMAN KNOT

Time: 10 min

OBJECTIVE

The objective of this activity is to untangle the “human knot” through teamwork.



This activity highlights the necessity for communication, mutual cooperation and support, including everyone and ensuring a better outcome, high esprit de corps and sharing a common goal.

RESOURCES

N/A.

ACTIVITY LAYOUT

- Divide the class into groups of approximately 10 cadets.

- Direct each group to stand in a circle and place their right hand in the centre and take the hand of anyone except the person on either side of them.
- Have them do the same with their left hands.
- Explain to the cadets that they must not let go of their hands, and that their job is to work together to untangle the “Human Knot.”

SAFETY

Ensure the area where this activity is being conducted is flat and open so as to avoid any falls or collisions with other objects.

INSTRUCTOR GUIDELINES



At this point the instructor shall brief the cadets on any safety rules or any other guidelines pertaining to the activity.

- During the activity ensure the rules of the activity are being followed.
- Give hints to help with the untangling process.

ACTIVITY 2 – MEMORY

Time: 10 min

OBJECTIVE

The objective of this activity is to remember as many of the items in the collage both as an individual and as a team.



This activity highlights tasks being easier when more people are involved, thereby ensuring a better outcome and high esprit de corps.

RESOURCES

- Collage found in Annex D.
- Overhead projector.
- Pens.
- Paper.
- Whiteboard/flipchart.
- Markers.

ACTIVITY LAYOUT

- Place a copy of the collage found in Annex D on the OHP.

- Turn the OHP on and have the cadets observe the overhead for 15 seconds.
- After 15 seconds turn the OHP off and have the cadets individually write down as many items as they can recall.
- After approximately two minutes record on the board/flipchart the number of items recalled on an individual basis.
- Split the cadets into two groups and have them compile a group list of items they recall.
- After two minutes compare the individual results to the group results.

SAFETY

N/A.

INSTRUCTOR GUIDELINES



At this point the instructor shall brief the cadets on any safety rules or any other guidelines pertaining to the activity.

- During the activity supervise and ensure all members are participating in the activity.
- Record on the board/flipchart individual and group results.

ACTIVITY 3 – SILENT BIRTHDAYS

Time: 10 min

OBJECTIVE

The objective of this activity is to line up according to birthdays without speaking to one another.



This activity highlights communication, mutual cooperation and support, high esprit de corps and sharing a common goal.

RESOURCES

- Pens.
- Paper.

ACTIVITY LAYOUT

- Direct the cadets to line up in birth order from oldest to youngest by not talking to one another.
- If the task becomes daunting for the cadets provide a method to assist them (i.e. using pens and paper).
- The pens and paper can be laid out on a table in the vicinity of the activity.

- When the time is up, starting at the beginning of the line, have each cadet state his or her birthday to see if the task was successful.

SAFETY

N/A.

INSTRUCTOR GUIDELINES



At this point the instructor shall brief the cadets on any safety rules or any other guidelines pertaining to the activity.

- During the activity help the cadets (i.e. using pens and paper, using some kind of sign language, etc.) if the activity is going over time.
- Supervise and ensure all cadets are participating in the activity.

REFLECTION

Time: 20 min

Method: Group Discussion

GROUP DISCUSSION



Instructors shall ensure that all lesson objectives are drawn out towards the end of the reflection stage.

DISCUSSION QUESTIONS



TIPS FOR ANSWERING/FACILITATING DISCUSSION

- Ask questions that help facilitate discussion; in other words, avoid questions with yes or no answers.
- Prepare questions ahead of time.
- Be flexible (you are not bound to only the prepared questions).
- Encourage cadets to participate by using praise such as “great idea” or “excellent response, can anyone add to that?”.
- Try to involve everyone by directing questions to non-participants.

SUGGESTED QUESTIONS

- Q1. What advantages of teamwork were noticed while engaging in the activities?
- Q2. What things made the team successful in the activities?
- Q3. What things were frustrating throughout the activities?

Q4. Why do you think teamwork is important?



Other questions and answers will develop throughout the reflection stage. The discussion should not be limited to only those suggested.

CONCLUSION

REVIEW

Upon completion of the group discussion conclude by summarizing to ensure that all teaching points have been covered. Take the opportunity to explain how the cadet will apply this knowledge and/or skill in the future.

MAIN TEACHING POINTS

TP1. Characteristics of a successful team.

TP2. Advantages of effective teamwork.



Instructors shall reinforce those answers and comments discussed during reflection, but must ensure that the main teaching points have been covered. Any main teaching point not brought out during the group discussion shall be emphasized during the review.

HOMEWORK/READING/PRACTICE

N/A.

METHOD OF EVALUATION

There is no formal assessment of this EO.

CLOSING STATEMENT

Teamwork is essential to a successful outcome. Knowing what skills contribute to the success of a team will aid in this. Development of these skills will occur each and every time an individual is involved in a team.

INSTRUCTOR NOTES/REMARKS

N/A.

REFERENCES

- C0-003 (ISBN 0-943210-44-5) Pike, B., and Busse, C. (1995). *101 More Games for Trainers*. Minneapolis, MN: Lakewood Publishing.
- C0-004 (ISBN 1-58062-577-0) McClain, G., and Romaine, D.S. (2002). *The Everything Managing People Book*. Avon, MA: Adams Media.
- C0-005 (ISBN 0-07-046414-6) Scannell, E.E., and Newstrom, J.W. (1994). *Even More Games Trainers Play*. New York: McGraw-Hill.



COMMON TRAINING INSTRUCTIONAL GUIDE



SECTION 4

EO C103.01 – PARTICIPATE IN ICEBREAKER ACTIVITIES

Total Time: 30 min

INTRODUCTION

PRE-LESSON INSTRUCTIONS

A complete list of resources needed for the instruction of this EO is located at Chapter 2 of the QSP. Specific uses for said stores are identified throughout the Instructional Guide, within the teaching point for which they are required.

Prior to instructing this lesson the instructor shall:

- review a lesson content, and become familiar with the material;
- prepare suitable instructional area; and
- prepare all materials listed in the Resources section of each activity.

PRE-LESSON ASSIGNMENT

N/A.

APPROACH

The small group activity was selected to allow for maximum participation in the learning process. It is an interactive way to illustrate and substantiate the lesson material in a concrete manner.

The group discussion method was chosen to allow the cadets to share their knowledge, opinions, and feelings about the subject matter while still allowing the instructor to control the direction of the discussion. The instructor must ensure that points not brought forth by the class are presented. If the instructor follows the Instructional Guide, including the questions posed, this will allow the cadets to express, in their own words, what they learned from this lesson and how they may apply the information.

REVIEW

N/A.

OBJECTIVES

By the end of this lesson the cadet shall have participated in icebreaker activities.

IMPORTANCE

Introductions are vital to the success of any team. Cadets may be spending a long period of time together with each other throughout their involvement with the program. These activities will assist in developing positive relationships.

BACKGROUND KNOWLEDGE

ICEBREAKERS

Icebreakers are a method for getting cadets to introduce themselves. These exercises may vary according to the type of training being conducted, the size of the group, and how well the group members know each other. Icebreakers encourage self-disclosure, humour, respect for others, thought and creativity. Most importantly, they allow people to laugh at themselves.

ACTIVITY 1 – TRUE CONFESSION TOOTHPICKS

Time: 7 min

OBJECTIVE

The objective of this activity is to assist cadets in getting to know each other by challenging participants to think creatively.

RESOURCES

A large supply of toothpicks.

ACTIVITY LAYOUT

- Give each cadet five toothpicks.
- Select a cadet to go first; ask them to talk about something they have never done (e.g. I have never jay walked).
- After the statement, anyone in the group who has done the action must forfeit a toothpick.
- The next person then shares something they have never done. Again, someone who has done the action must forfeit a toothpick.
- The disclosers continue until someone has lost all five toothpicks.

SAFETY

N/A.

INSTRUCTOR GUIDELINES



At this point the instructor shall brief the cadets on any safety rules or any other guidelines pertaining the activity.

- The number of toothpicks may be adjusted dependent on the size of the group to meet timings.

- A circle classroom arrangement may be appropriate for this activity.

ACTIVITY 2 – TWO TRUTHS AND A LIE

Time: 7 min

OBJECTIVE

The objective of this activity is to expand on the amount of information typically heard from someone during an introduction by determining which one of the statements is a lie.

RESOURCES

N/A.

ACTIVITY LAYOUT

- Each member of the group shall introduce themselves using three statements, two being the truth and one being a lie.
- The other members of the group must determine which statement is a lie.
- The activity continues until each cadet has had an opportunity to make three statements.

SAFETY

N/A.

INSTRUCTOR GUIDELINES



At this point the instructor shall brief the cadets on any safety rules or any other guidelines pertaining the activity.

- Ensure the timings for this activity are adhered to.
- Cadets may be split into small groups if the class is too large.
- Ensure there is adequate supervision of the groups.

ACTIVITY 3 – SELF-DISCLOSER INTRODUCTIONS

Time: 7 min

OBJECTIVE

The objective of this activity is to provide innovative ways for the cadets to one another by adding adjectives to their first or last names.

RESOURCES

N/A.

ACTIVITY LAYOUT

Direct cadets to state their first or last name with an adjective put in front. The adjective should describe a dominant characteristic and start with the first letter of the first or last name. For example: Serious Stan, Mathematical Mary.

SAFETY

N/A.

INSTRUCTOR GUIDELINES



At this point the instructor shall brief the cadets on any safety rules or any other guidelines pertaining the activity.

- Ensure the timing is adhered to.
- If time permits, ask cadets why they chose their adjective.

REFLECTION

Time: 5 min

Method: Group Discussion

GROUP DISCUSSION



Instructors shall ensure that all lesson objectives are drawn out towards the end of the reflection stage.

DISCUSSION QUESTIONS



TIPS FOR ANSWERING/FACILITATING DISCUSSION

- Ask questions that help facilitate discussion; in other words, avoid questions with yes or no answers.
- Prepare questions ahead of time.
- Be flexible (you are not bound to only the prepared questions).
- Encourage cadets to participate by using praise such as “great idea” or “excellent response, can anyone add to that?”.
- Try to involve everyone by directing questions to non-participants.

SUGGESTED QUESTIONS

- Q1. Did the tasks help you introduce yourselves to one another?
- Q2. Did the activity help include everyone in the team environment?

- Q3. How did you feel about the others in the group after the activity was completed?
- Q4. Was it surprising when the group thought someone's statement was a lie and it was really the truth? (only for Activity 2)



Other questions and answers will develop throughout the reflection stage. The discussion should not be limited to only those suggested.

CONCLUSION

REVIEW

Upon completion of the group discussion, conclude by summarizing to ensure that all main ideas have been covered. Take the opportunity to explain how the cadet will apply this knowledge and/or skill in the future.

MAIN TEACHING POINTS

TP1. Participate in icebreaker activities.



Instructors shall reinforce those answers and comments discussed during reflection, but must ensure that the main ideas have been covered. Any main idea not brought out during the group discussion shall be brought up during review.

HOMEWORK/READING/PRACTICE

N/A.

METHOD OF EVALUATION

There is no formal assessment of this EO.

CLOSING STATEMENT

Introductions are vital to the success of any team. Cadets may be spending a long period of time together through their involvement with the program. These activities will assist in developing positive relationships.

INSTRUCTOR NOTES/REMARKS

N/A.

REFERENCES

- C0-003 (ISBN 0-943210-44-5) Pike, B., and Busse, C. (1995). *101 More Games for Trainers*. Minneapolis, MN: Lakewood Books.
- C0-028 (ISBN 0-07-046513-4) Newstrom, J., and Edward, S. (1998). *The Big Book of Teambuilding Games*. New York, NY: McGraw-Hill.
- C0-029 (ISBN 0-7872-4532-1) Cain, J., and Jolliff, B. (1998). *Teamwork and Teamplay*. Brockport, NY: Kendall/Hunt.

THIS PAGE INTENTIONALLY LEFT BLANK



COMMON TRAINING INSTRUCTIONAL GUIDE



SECTION 5

EO C103.02 – PARTICIPATE IN SELF-INTRODUCTIONS

Total Time:

30 min

INTRODUCTION

PRE-LESSON INSTRUCTIONS

The instructor shall review the lesson content and become familiar with the material prior to instruction of the lesson.

A complete list of resources needed for the instruction of this EO is located at Chapter 2 of the QSP. Specific uses for said stores are identified throughout the Instructional Guide, within the teaching point for which they are required.

PRE-LESSON ASSIGNMENT

N/A.

APPROACH

The small group activity was selected to allow for maximum participation in the learning process. It is an interactive way to illustrate and substantiate the lesson material in a concrete manner.

The group discussion method was chosen to allow the cadets to share their knowledge, opinions, and feelings about the subject matter while still allowing the instructor to control the direction of the discussion. The instructor must ensure that points not brought forth by the class are presented. If the instructor follows the Instructional Guide, including the questions posed, this will allow the cadets to express, in their own words, what they learned from this lesson and how they may apply the information.

REVIEW

N/A.

OBJECTIVES

By the end of this lesson the cadets shall be expected to have introduced themselves to the class.

IMPORTANCE

Communication is an important aspect of leadership. Being able to communicate with other members of the group and the leader will lead to successful completion of tasks. Starting with a short, informal introduction will give the cadets confidence to start developing their communication skills.

BACKGROUND KNOWLEDGE

COMMUNICATION

Effective communication skills are key to any successful group or team and are an important factor in becoming an effective leader. A leader who can communicate effectively with the team will move the team towards a positive outcome.

Communication works in both directions. When one person is delivering a message, the team members must be listening to ensure they receive the message correctly. Part of becoming a leader is developing good listening skills. Team members should feel comfortable enough to bring forth ideas to the leader and feel that their ideas are heard and taken into account.

ACTIVITY

Time: 20 min

OBJECTIVE

The objective of this activity is to have each of the cadets present themselves to the class.

RESOURCES

- Whiteboard with markers.
- Pens.
- Paper.

ACTIVITY LAYOUT

- Have each cadet stand in front of the class and present a short introduction.
- The introduction should include information such as:
 - their name;
 - what school they attend;
 - what grade they are in;
 - why they joined cadets;
 - their hobbies;
 - their interests; and
 - their general career ambitions.
- Write this list on the board for the cadets to reference during the introduction.
- Give the cadets two minutes to write some notes to use during the introduction.
- Each introduction should be no more than two minutes in length.

SAFETY

N/A.

INSTRUCTOR GUIDELINES



At this point the instructor shall brief the cadets on any safety rules or any other guidelines pertaining the activity.

- During the activity ensure the two-minute time limit is enforced and that all cadets participate in the introductions.
- If the class is big, divide the group into smaller groups and use assistant instructors to facilitate the introductions.

REFLECTION

Time: 5 min

Method: Group Discussion

GROUP DISCUSSION



Instructors shall ensure that all lesson objectives are drawn out towards the end of the reflection stage.

DISCUSSION QUESTIONS



TIPS FOR ANSWERING/FACILITATING DISCUSSION

- Ask questions that help facilitate discussion; in other words, avoid questions with yes or no answers.
- Prepare questions ahead of time.
- Be flexible (you are not bound to only the prepared questions).
- Encourage cadets to participate by using praise such as “great idea” or “excellent response, can anyone add to that?”.
- Try to involve everyone by directing questions to non-participants.

SUGGESTED QUESTIONS

- Q1. How does this exercise emphasize the importance of communication?
- Q2. Why is communication important in a team setting?
- Q3. What feelings were experienced while introducing yourself?



Other questions and answers will develop throughout the reflection stage. The discussion should not be limited to only those suggested.

CONCLUSION

REVIEW

Upon completion of the group discussion summarize to ensure that all teaching points have been covered. Take this opportunity to explain how the cadet will apply this knowledge and/or skill in the future.

MAIN TEACHING POINTS

TP1. Communication.



Instructors shall reinforce those answers and comments discussed during reflection, but must ensure that the main teaching points have been covered. Any main teaching point not brought out during the group discussion shall be brought up during the review.

HOMEWORK/READING/PRACTICE

N/A.

METHOD OF EVALUATION

There is no formal assessment of this EO.

CLOSING STATEMENT

Being able to communicate with others is essential in leadership both as a follower and a leader. Participating in self-introductions will give the cadet confidence to communicate with others in the group and with the leader.

INSTRUCTOR NOTES/REMARKS

This lesson should be conducted early in the training year because it will act as an icebreaker for the cadets.

REFERENCES

C0-021 (ISBN 1-58062-513-4) Adams, B. (2001). *The Everything Leadership Book*. Avon, MA: Adams Media.



COMMON TRAINING INSTRUCTIONAL GUIDE



SECTION 6

EO C103.03 – PARTICIPATE IN TEAM BUILDING ACTIVITIES

Total Time: 30 min

INTRODUCTION

PRE-LESSON INSTRUCTIONS

A complete list of resources needed for the instruction of this EO is located at Chapter 2 of the QSP. Specific uses for said stores are identified throughout the Instructional Guide, within the teaching point for which they are required.

Prior to instructing this lesson the instructor shall:

- review a lesson content, and become familiar with the material;
- prepare suitable instructional area; and
- prepare all materials listed in the Resources section of each activity.

PRE-LESSON ASSIGNMENT

N/A.

APPROACH

The small group activity was selected to allow for maximum participation in the learning process. It is an interactive way to illustrate and substantiate the lesson material in a concrete manner.

The group discussion method was chosen to allow the cadets to share their knowledge, opinions, and feelings about the subject matter while still allowing the instructor to control the direction of the discussion. The instructor must ensure that points not brought forth by the class are presented. If the instructor follows the Instructional Guide, including the questions posed, this will allow the cadets to express, in their own words, what they learned from this lesson and how they may apply the information.

REVIEW

The pertinent review for this lesson will include principles of teamwork discussed in EO M103.03 (Section 3). These are listed in the Background Knowledge section.

OBJECTIVES

By the end of this lesson the cadet shall have participated in team building activities.

IMPORTANCE

Acquiring the skills needed to work as an effective team member is essential to achieving the team's goals.

BACKGROUND KNOWLEDGE

CHARACTERISTICS OF A SUCCESSFUL TEAM

- **Communication.** Clear communication is essential to an effective team. Team members must feel comfortable sharing ideas and concerns with each other and the leader.
- **Mutual Cooperation and Support.** It is hard to be innovative when you are not sure how others will react to your ideas. Team members must be aware that even if people disagree the objection is to the idea, not to the person presenting it. Members of a team must have the right to a certain level of trust that precludes backstabbing, gossip, and negative behaviours aimed solely at making someone look bad.
- **Share a Common Goal.** When a team understands the reason for the task they have a heightened motivation to work together to complete the task.
- **High Esprit de Corps.** When each member of the team feels proud and has a sense of belonging to the team, it is more likely they will want to be part of the team. This sense of belonging will enable the group to become more cohesive and willing to work together to accomplish the task.

ADVANTAGES OF EFFECTIVE TEAMWORK

- **Includes Everyone and Ensures a Better Outcome.** In a team setting people feel that their contributions are valuable. A strong group performance is generated from strong individual efforts. When many individuals are working together to accomplish a task different ideas and opinions mesh together to provide a sound outcome.
- **Tasks Are Easier When More People Are Involved.** When the responsibility and workload are shared among all team members, the team works together to ensure everyone stays on track and offers support to those who need it.
- **Increases and Develops Communication.** Teamwork is an opportunity to get people interacting in new ways by forming relationships and communicating with new people. Communication is the key to ensuring members are carrying out their role in accomplishing the task.

ACTIVITY 1 – JIGSAW TEAM BUILDING

Time: 6 min

OBJECTIVE

The objective of this activity is to stress the importance of each team member's individual contributions and the importance of working as a group.

RESOURCES

- One previously constructed picture puzzle, divided into sets of approximately 10 pieces per participant, broken apart and allocated to each cadet for reassembly.
- CD player (optional).
- Appropriate CDs (optional).

ACTIVITY LAYOUT

- Select a suitable picture puzzle (attached at Annex E).

- Break the puzzle into nine connectable subsets (so the subsets can be connected to each other).
- Distribute the subsets to each participant (divide cadets into groups if there are more than nine participants).
- Have the cadets assemble the subsets of the puzzle.
- After the subsets are assembled, have the cadets come together to join the subsets and form the full picture.
- Set a challenging time limit for the activity and play energizing music to create a sense of urgency.

SAFETY

N/A.

INSTRUCTOR GUIDELINES



At this point the instructor shall brief the cadets on any safety rules or any other guidelines pertaining the activity.

- A small number of participants may be designated as free floating trouble-shooters who roam around the room and help those who are having trouble.
- Supervise to ensure all group members are participating equally. Some cadets may be reluctant to give up their puzzle pieces. Others may try to take control of all of the pieces and attempt to assemble the puzzle.

REFLECTION

Time: 4 min

Method: Group Discussion

GROUP DISCUSSION



Instructors shall ensure that all lesson objectives are drawn out towards the end of the reflection stage.

DISCUSSION QUESTIONS



TIPS FOR ANSWERING/FACILITATING DISCUSSION

- Ask questions that help facilitate discussion; in other words, avoid questions with yes or no answers.
- Prepare questions ahead of time.
- Be flexible (you are not bound to only the prepared questions).
- Encourage cadets to participate by using praise such as “great idea” or “excellent response, can anyone add to that?”.
- Try to involve everyone by directing questions to non-participants.

SUGGESTED QUESTIONS

- Q1. What was the reaction you experienced when you realized your importance to the overall team?
- Q2. What impact did the time deadline have on the effectiveness the group completing the task?
- Q3. What was the impact of having team members available to help with the task?
- Q4. What do you feel the completed picture puzzle represents?
- Q5. Ask the cadets to consider both their productive and counterproductive behaviours. It is likely that they are using the same behaviours in actual team environments, with similar positive and negative effects.



Other questions and answers will develop throughout the reflection stage. The discussion should not be limited to only those suggested.

ACTIVITY 2 – ALPHABETICALLY

Time: 11 min

OBJECTIVE

The objective of this activity is to stress the importance of each team member’s individual contributions and the importance of working as a group.

RESOURCES

Blindfolds (optional).

ACTIVITY LAYOUT

- Begin with the cadets sitting or standing in random locations throughout the activity area with their eyes closed (or blindfolds on).
- Direct one cadet to say the first letter of the alphabet.

- The remainder of the cadets must now state the remaining letters in order without ever having two cadets saying the same letter at the same time.

SAFETY

N/A.

INSTRUCTOR GUIDELINES



At this point the instructor shall brief the cadets on any safety rules or any other guidelines pertaining the activity.

- The activity can use any sequence instead of the alphabet, dependent on the size of the group (numbers, days of the week, months of the year, holidays, etc.). Select the appropriate sequence for the size of the group so as to remain within the time limitations.
- Once the cadets have completed the task, have them perform this activity with their eyes open. This should increase the success rate.

REFLECTION

Time: 4 min

Method: Group Discussion

GROUP DISCUSSION



Instructors shall ensure that all lesson objectives are drawn out towards the end of the reflection stage.

DISCUSSION QUESTIONS



TIPS FOR ANSWERING/FACILITATING DISCUSSION

- Ask questions that help facilitate discussion; in other words, avoid questions with yes or no answers.
- Prepare questions ahead of time.
- Be flexible (you are not bound to only the prepared questions).
- Encourage cadets to participate by using praise such as “great idea” or “excellent response, can anyone add to that?”.
- Try to involve everyone by directing questions to non-participants.

SUGGESTED QUESTIONS

- Q1. Did the group try to use any non-verbal clues to determine the order within the group? If so, what were they and did they assist in completing the task?

- Q2. What makes this activity so difficult?
- Q3. If a pattern was created, was the activity then easier to complete?
- Q4. Was the activity easier to complete with eyes open? If so, why?
- Q5. How did you feel about the individual contribution that each cadet made?



Other questions and answers will develop throughout the reflection stage. The discussion should not be limited to only those suggested.

CONCLUSION

REVIEW

Upon completion of the group discussion, summarize to ensure that all main ideas have been covered. Take the opportunity to explain how the cadet will apply this knowledge and/or skill in the future.

MAIN TEACHING POINTS

TP1. Participate in team building activities.



Instructors shall reinforce those answers and comments discussed during reflection, but must ensure that the main ideas have been covered. Any main teaching point not brought out during the group discussion shall be brought up during review.

HOMEWORK/READING/PRACTICE

N/A.

METHOD OF EVALUATION

There is no formal assessment for this EO.

CLOSING STATEMENT

Teamwork is essential to the outcome of a group task. Knowing what skills contribute to the success of a team will aid in a positive outcome. Development of these skills will occur each and every time an individual is involved in a team.

INSTRUCTOR NOTES/REMARKS

N/A.

REFERENCES

- C0-028 (ISBN 0-07-046513-4) Newstrom, J., and Edward, S. (1998). *The Big Book of Teambuilding Games*. New York, NY: McGraw-Hill.
- C0-029 (ISBN 0-7872-4532-1) Cain, J., and Jolliff, B. (1998). *Teamwork and Teamplay*. Brockport, NY: Kendall/Hunt.

WORD GAME

CERPTES HET DERLEA NDA EHORT AETM BESMERM

✂-----

RPCOEAEOT TWHI TERSOH

✂-----

IAMTD STSAKIEM DNA RLENA MFOR XRPEIECNEE

✂-----

PCETCA SRUCONTTIVEC IIISCTMRC

✂-----

SUSAME YEBPISONSILRIT

✂-----

EB TENHOS

✂-----

EACTCP HTROE AEMT ESMBRME OFR HWO YEHT RAE

✂ -----

NOWK ETH BOJ NAD EB PPRDREAE

✂ -----

MAOCMUENCIT LYEACRL TIHW EHORST

✂ -----

SELF-ESTEEM SCALE

To get a sense of your level of self-esteem, place a check mark on the scale on the activity below which best describes you. For example, if you are more likely to act toward the item on the right, then the x would be placed closer to the right, and vice versa.

Throughout the year, feel free to revisit this scale and use it as a tool to monitor how your self-esteem in different areas may change.

	5	4	3	2	1	
Make your own decisions?	-----					Let others make them for you?
Look for answers to problems?	-----					Let problems defeat you?
Take risks?	-----					Play it safe?
Control your moods and thoughts yourself?	-----					Let someone else's bad mood get you down?
Feel exhilarated when you work hard?	-----					Feel as if you haven't accomplished anything, when you work hard?
Accept responsibility?	-----					Make excuses, find fault, lay blame.
Measure yourself against your own standards?	-----					Measure yourself against other's standards?
Speak up, set limits, voice your thoughts honestly?	-----					Swallow your opinions, your thoughts, your wishes?
Stand straight and look people in the eye?	-----					Slouch, with downcast eyes, looking sideways at people?
Respond flexibly to changing circumstances?	-----					Hold on to what you've always done and thought because it's easy and comfortable.
Feel self-confident and self-assured?	-----					Feel shy, nervous, and awkward?

THIS PAGE INTENTIONALLY LEFT BLANK

GOAL MAPPING EXERCISE

SHORT-TERM GOALS

Goal No. 1: _____

Steps To Take: _____

Goal No. 2: _____

Steps To Take: _____

LONG-TERM GOALS

Goal No. 1: _____

Steps To Take: _____

Goal No. 2: _____

Steps To Take: _____

THIS PAGE INTENTIONALLY LEFT BLANK

MEMORY GAME

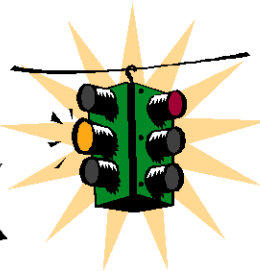
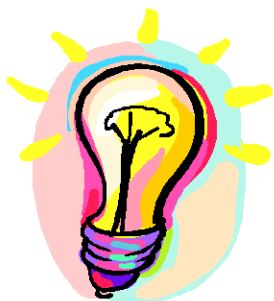
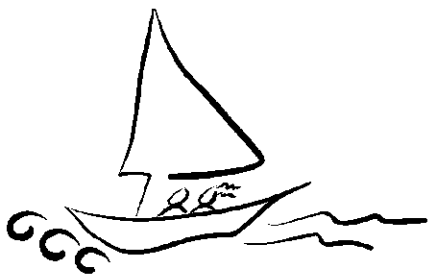
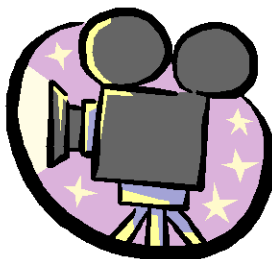
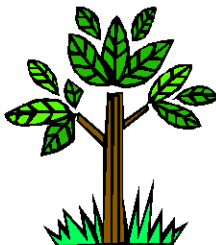
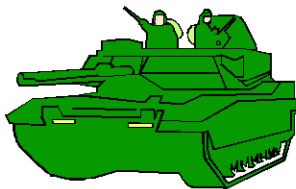

THIS PAGE INTENTIONALLY LEFT BLANK

PUZZLES

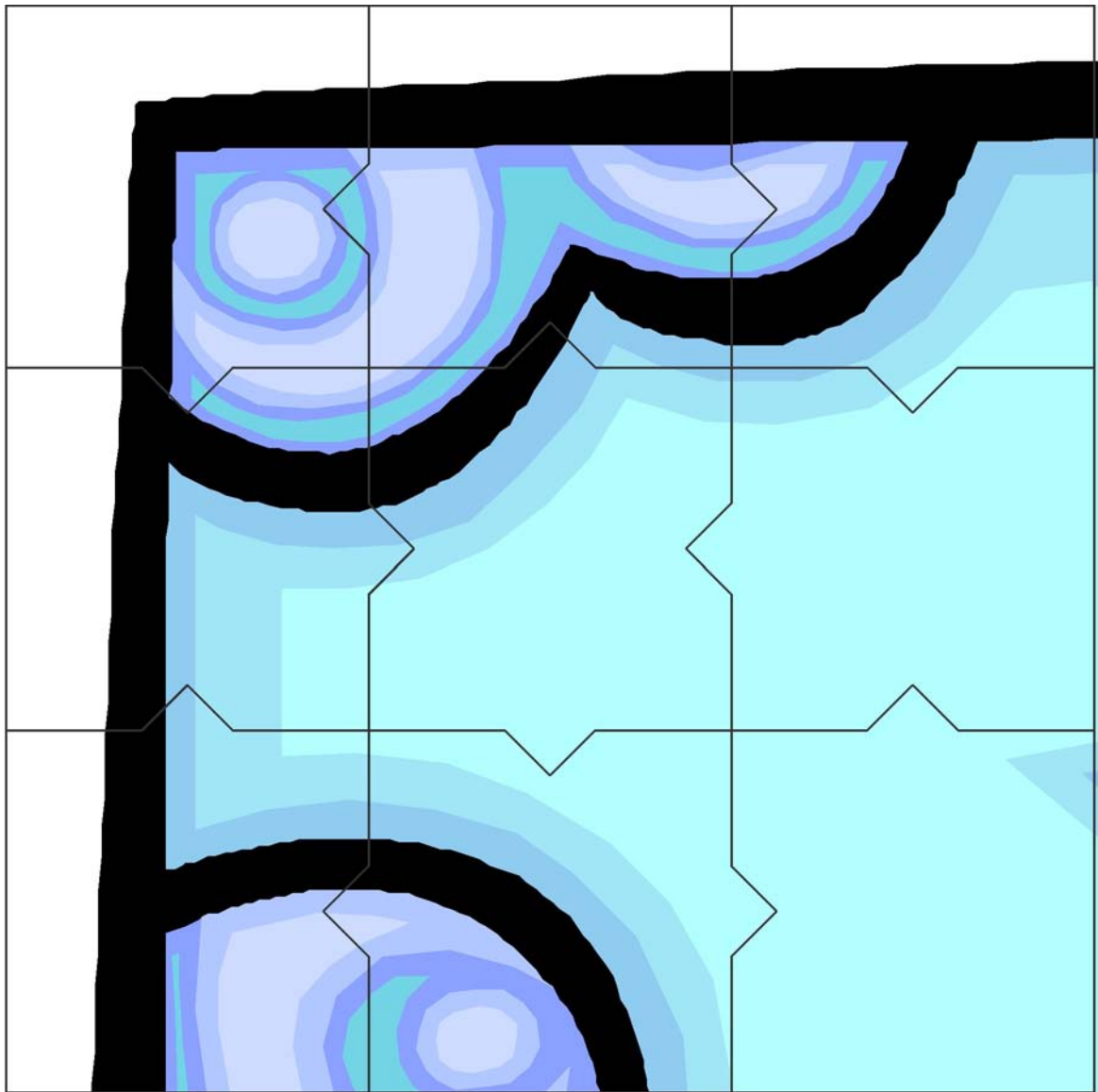

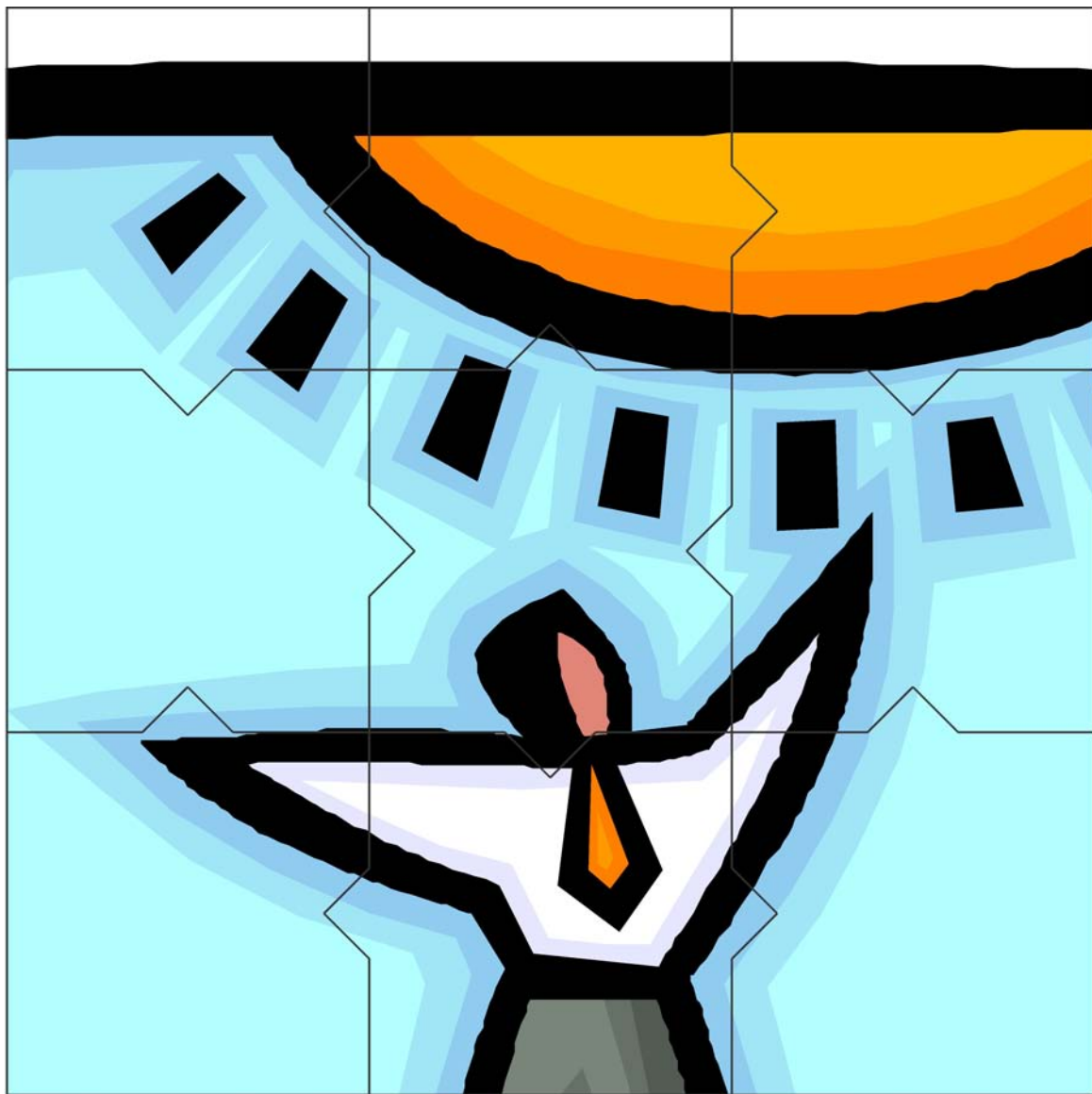

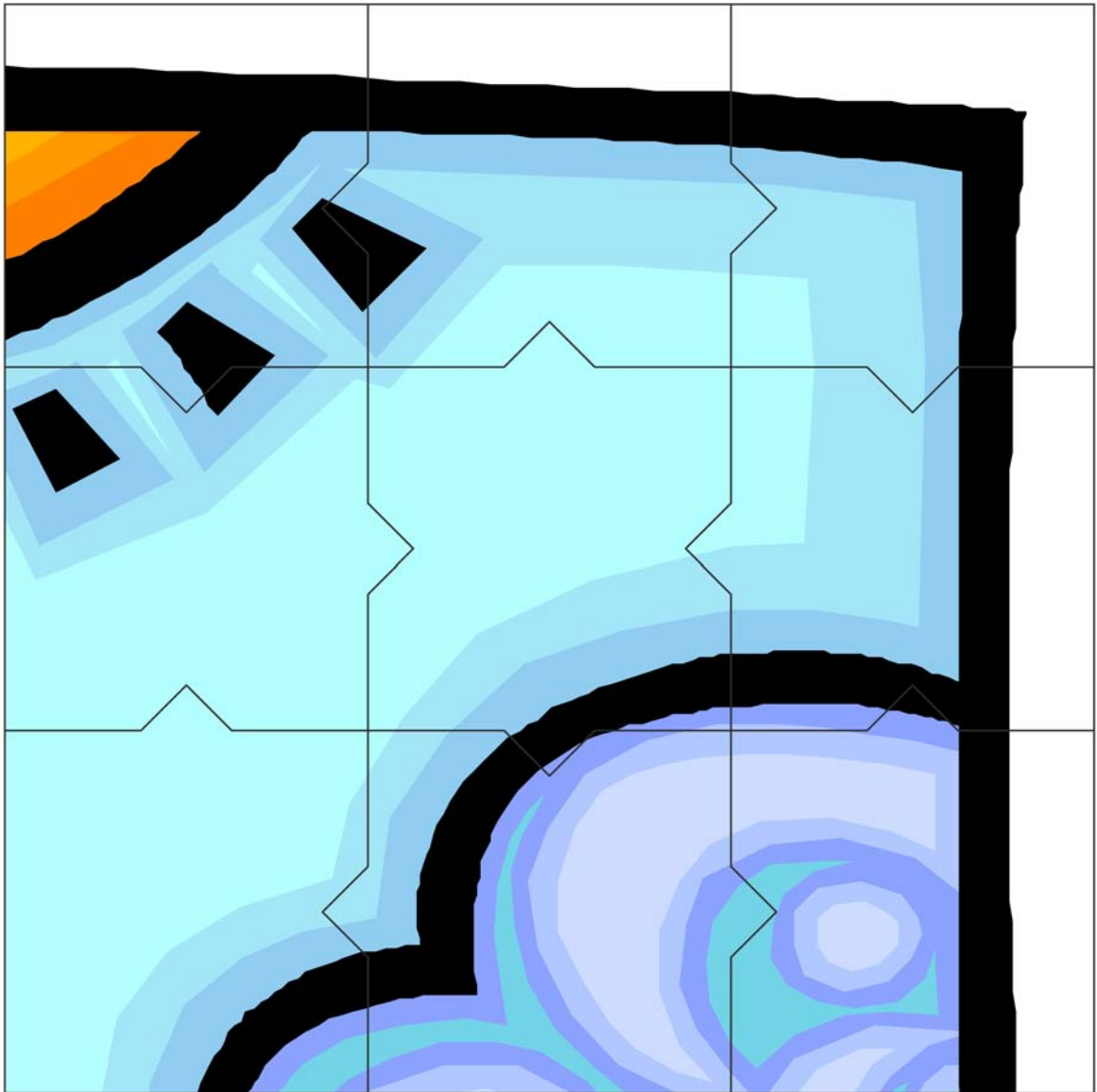

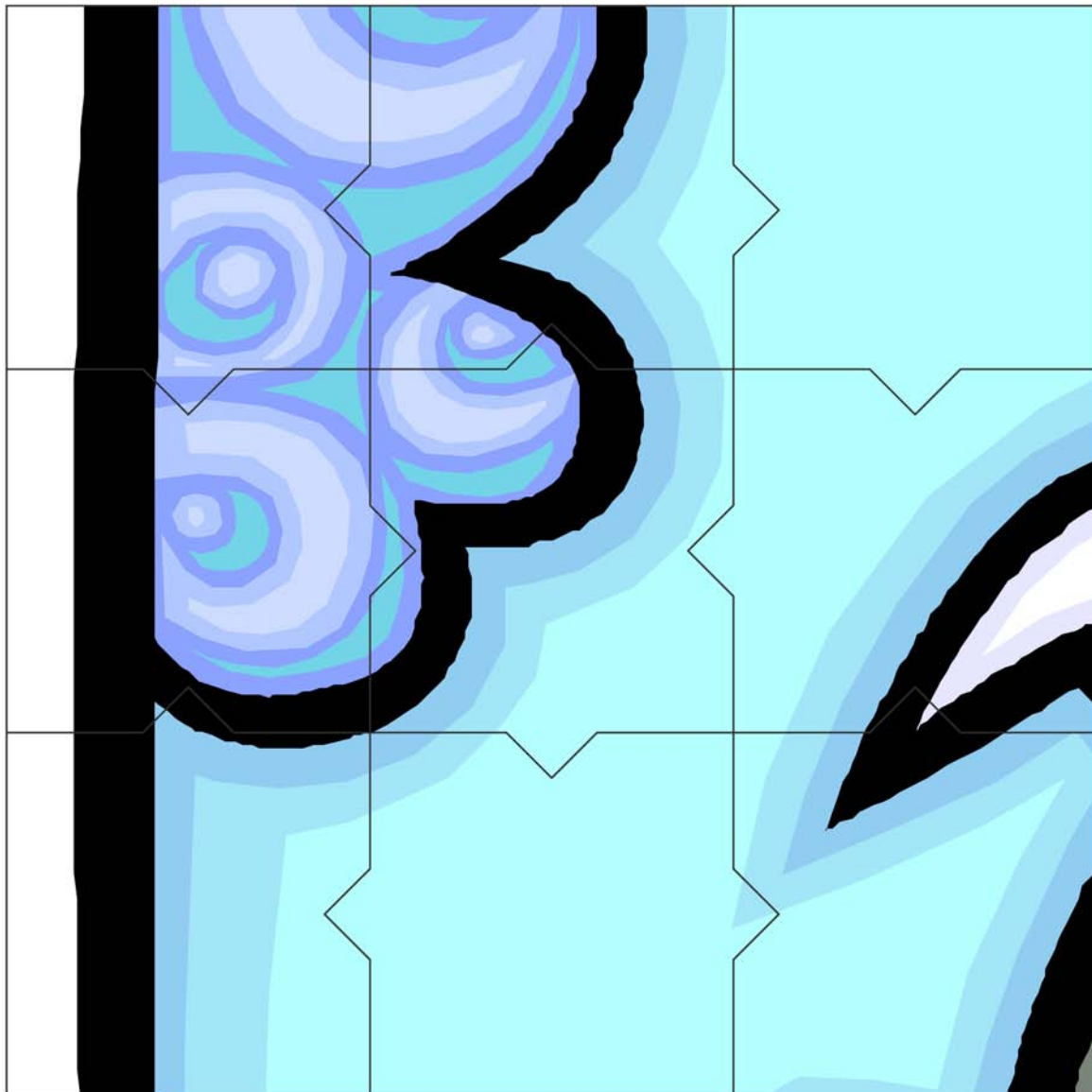

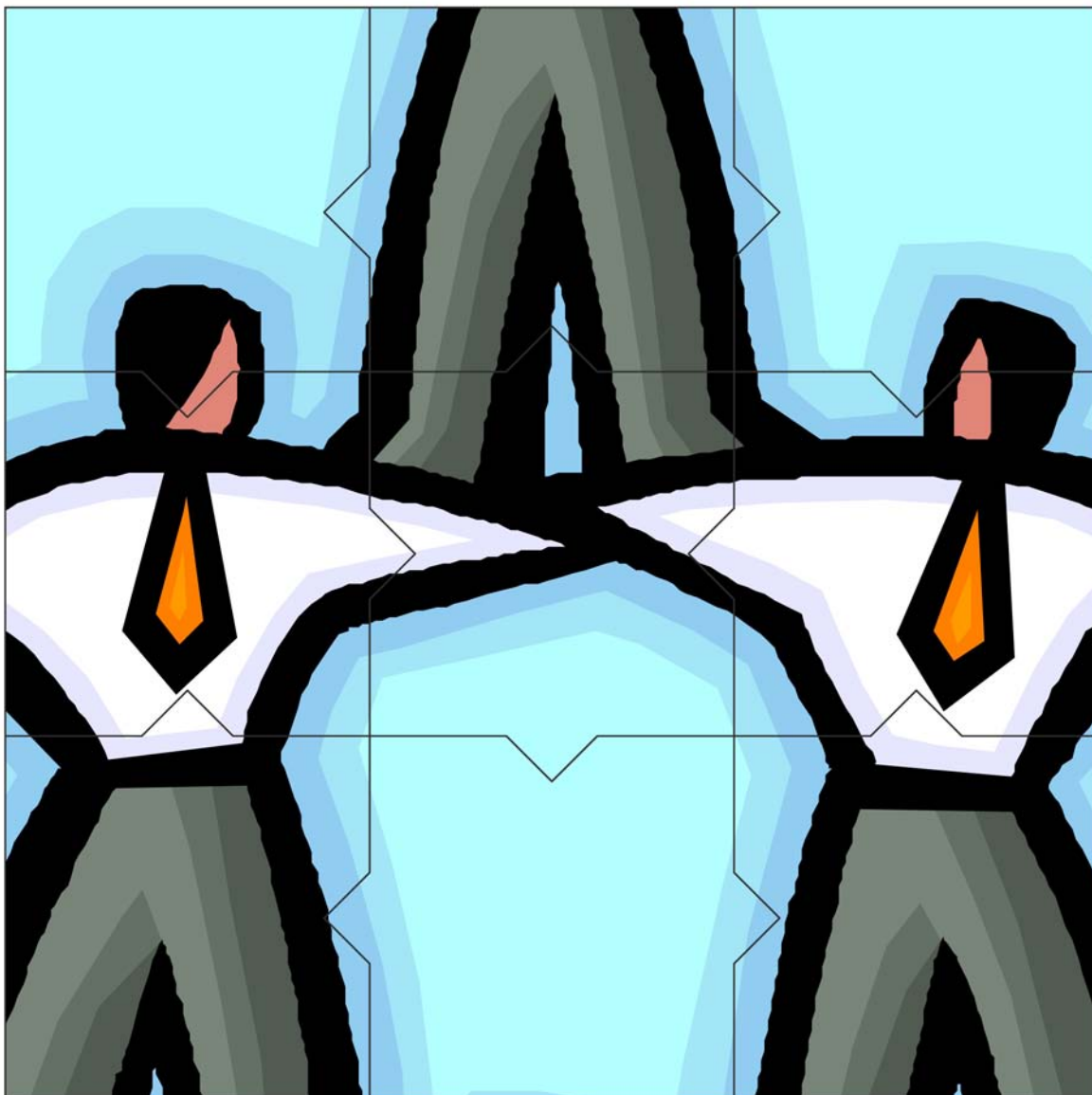

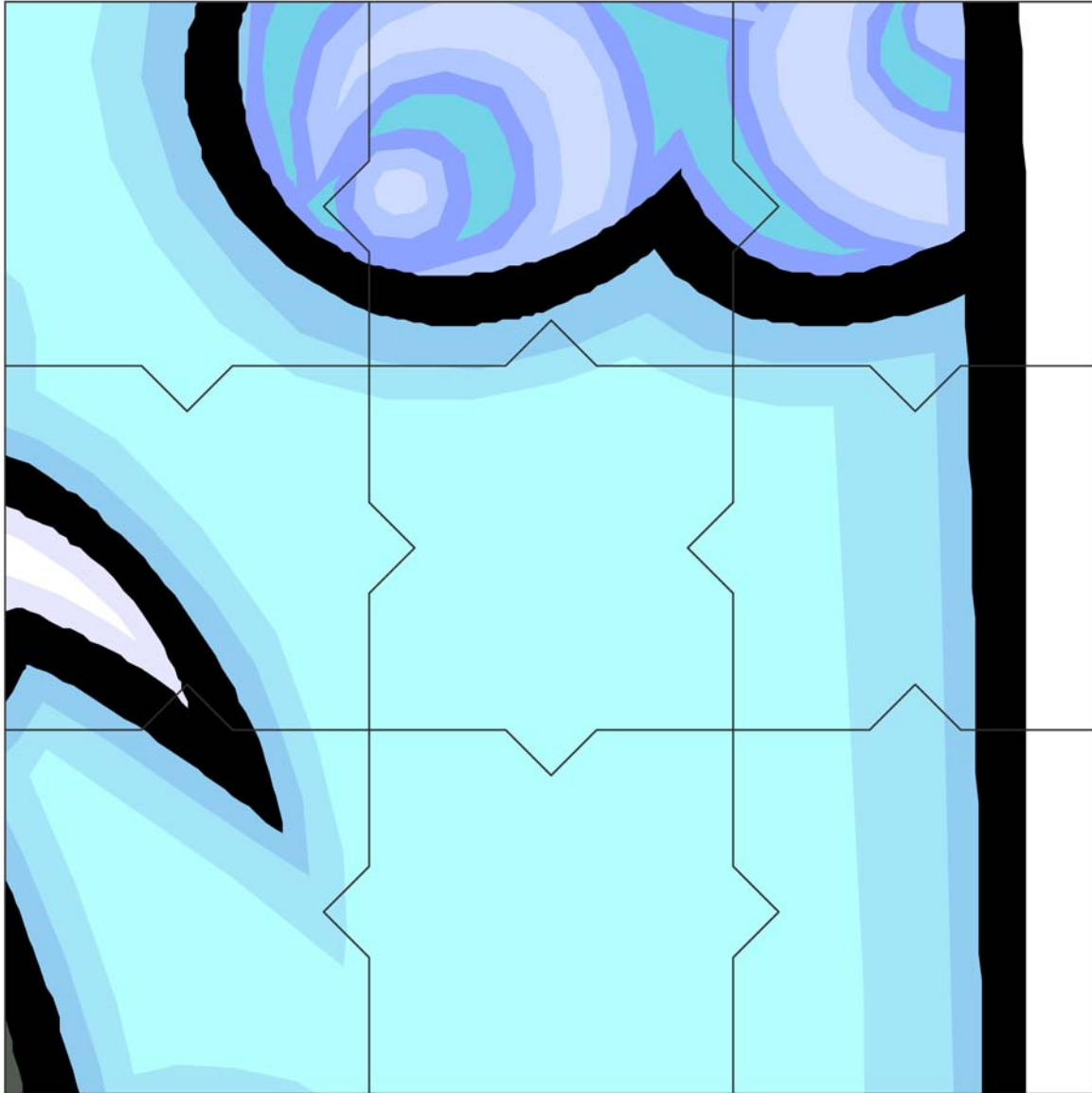

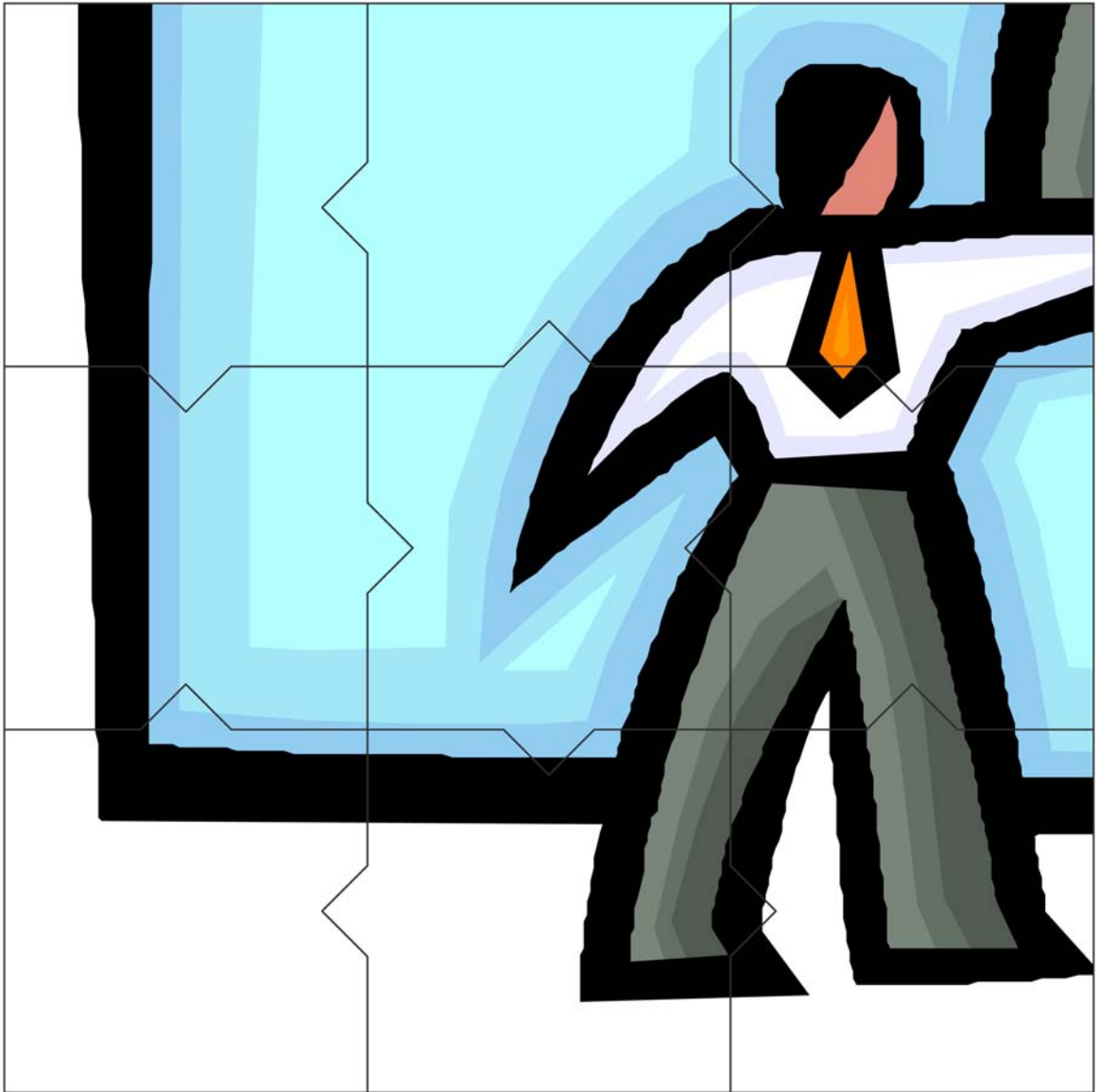

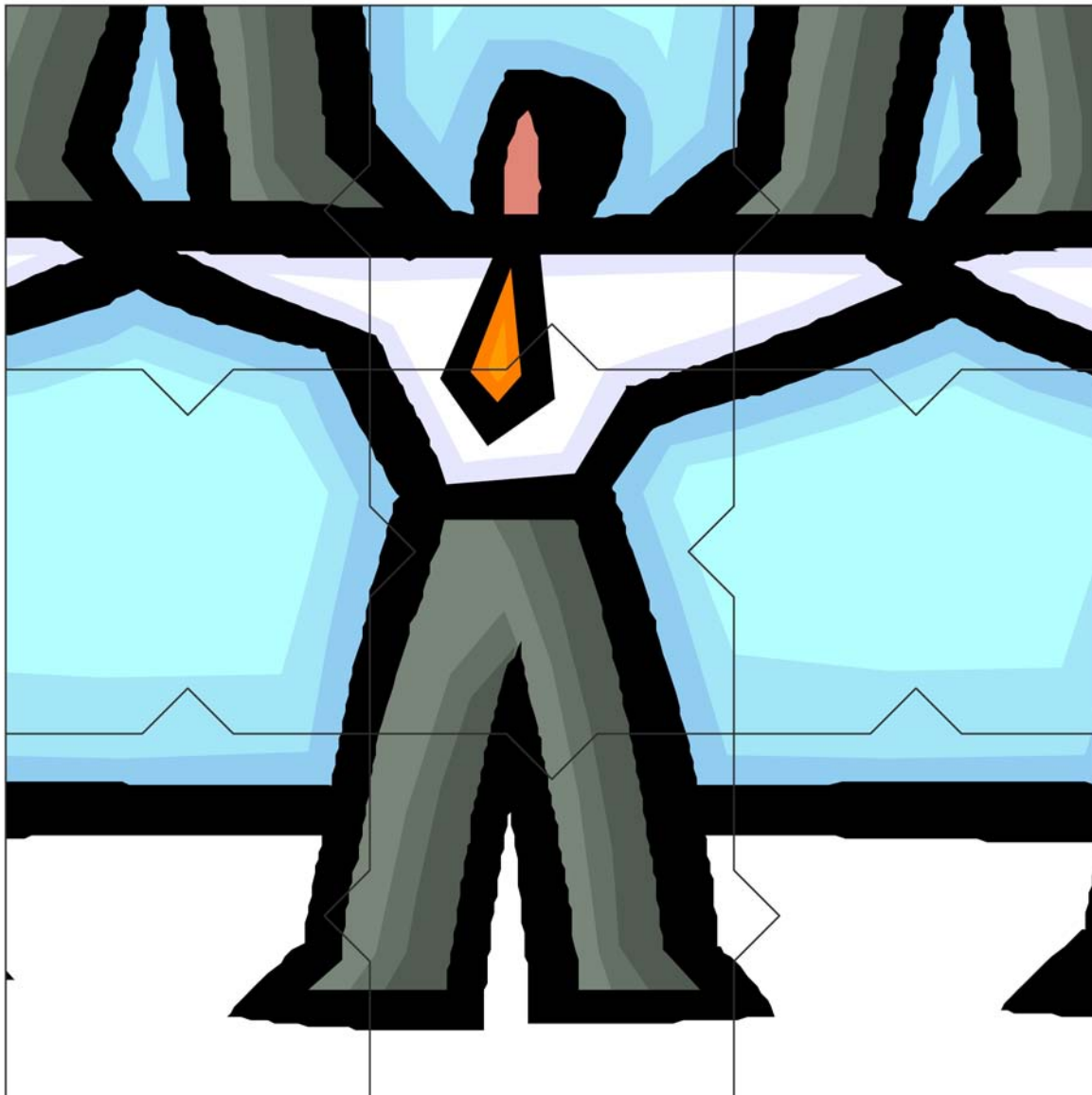

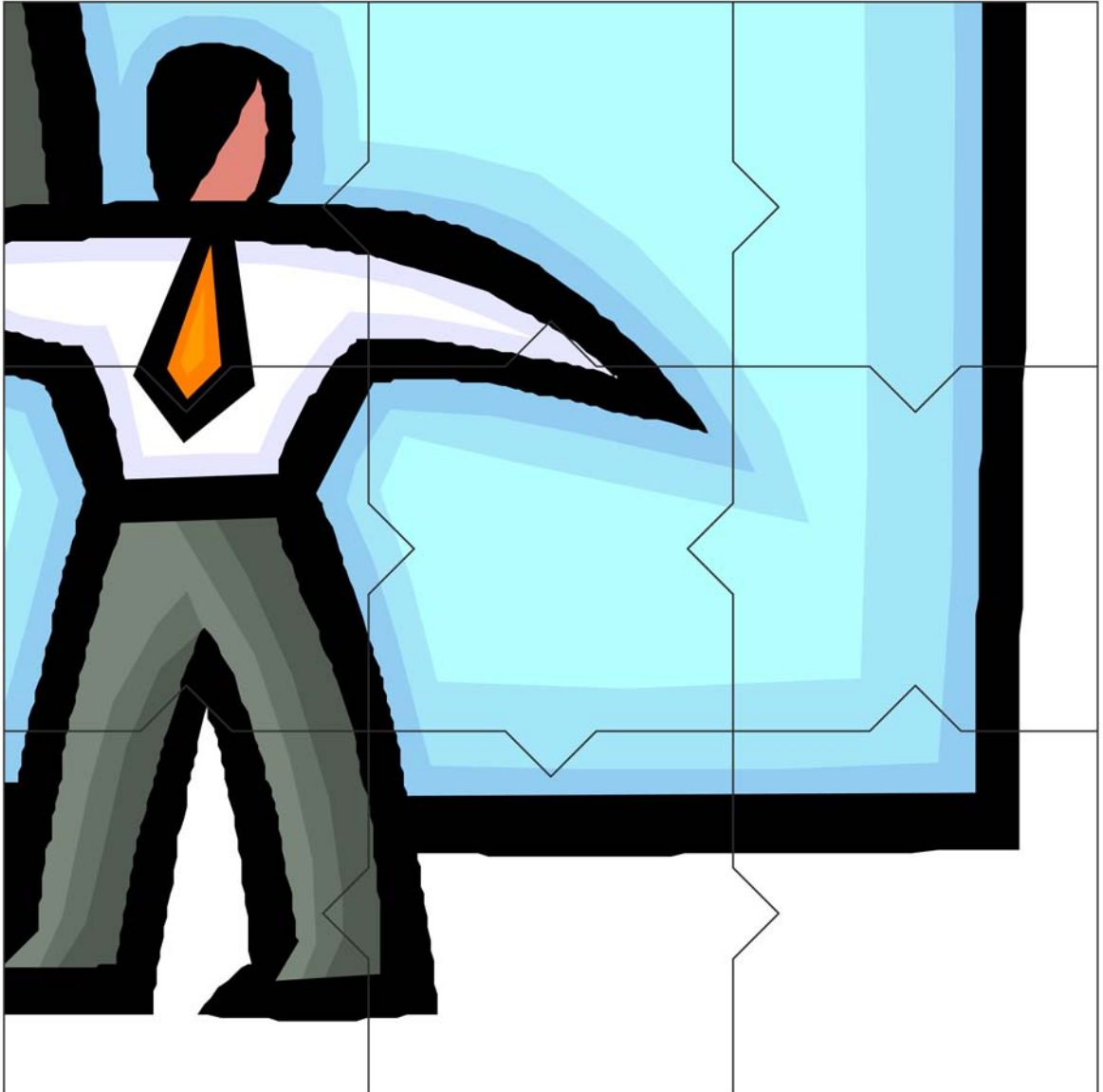

THIS PAGE INTENTIONALLY LEFT BLANK

CHAPTER 4

PO 104 – DEVELOP A PERSONAL ACTIVITY PLAN



COMMON TRAINING INSTRUCTIONAL GUIDE



SECTION 1

EO M104.01 – IDENTIFY ACTIVITIES THAT WILL HELP ACHIEVE A HEALTHY ACTIVE LIFESTYLE

Total Time: 30 min

INTRODUCTION

PRE-LESSON INSTRUCTIONS

A complete list of resources needed for the instruction of this EO is located at Chapter 2 of the QSP. Specific uses for said stores are identified throughout the Instructional Guide, within the teaching point for which they are required.

The instructor shall review the lesson content and become familiar with the material prior to the instruction of the lesson.

PRE-LESSON ASSIGNMENT

N/A.

REVIEW

N/A.

OBJECTIVES

By the end of this lesson the cadet shall be expected to identify activities that will help them achieve a healthy and active lifestyle.

APPROACH

For TP1, the interactive lecture method was chosen as it allows the instructor to make a semi-formal presentation of the material where the cadets can participate by asking or responding to questions and commenting on the material. For this lesson, this method is most effective as it matches well the taxonomic level of the material and is age-appropriate by virtue of its participatory nature.

For TP2, the group discussion method was chosen to allow the cadets to share their knowledge, opinions, and feelings about the subject matter while still allowing the instructor to control the direction of the discussion. The instructor must ensure that points not brought forth by the class are presented. If the instructor follows the Instructional Guide, including the questions posed, this will allow the cadets to express, in their own words, what they learned from this lesson and how they may apply the information.

IMPORTANCE

Physical fitness is one of the three aims of the cadet program. Teaching the cadets what activities contribute to an active lifestyle will help them achieve physical fitness.

Teaching Point 1**Introduce Cadets to *Canada's Physical Activity Guide to Healthy Active Living***

Time: 7 min

Method: Interactive Lecture

CANADA'S PHYSICAL ACTIVITY GUIDE TO HEALTHY ACTIVE LIVING

Hand out *Canada's Physical Activity Guide to Healthy Active Living*, highlighting the following pages and information detailed there:

- **Page 4 – Check Out What You Are Doing Now.** Is your exercise time more than 90 minutes per day? Less than 90 minutes but more than 60? Less than 60 but more than 30? Have each cadet write down their activities from yesterday and two days ago to add up their total time.
- **Page 5 – Benefits of Physical Activity.** Meet new friends, improve physical self-esteem, achieve a healthy weight, build strong bones and strengthen muscles, maintain flexibility, promote good posture and balance, improve fitness, strengthen the heart, increase relaxation and promote healthy growth and development.
- **Page 6 – What Are You Into.** Walking, running, hiking, cycling, swimming, jogging, gymnastics, ice-skating, skiing, basketball, volleyball, tobogganing, soccer, football, tennis, baseball, softball, dancing, yoga, climbing, bowling, hockey, skateboarding, badminton, etc. Have the cadets brainstorm all the activities they can think of that they may be interested in.
- **Page 8 – Let's Get Active.** Increase the time currently spent on physical activity and reduce non-active time.
- **Page 10 – Crank Up Your Activity.** Walking instead of taking the bus, playing ball at breaks, walking the dog, raking leaves, shovelling snow, carrying groceries, etc. Brainstorm ideas that will help increase current physical activity.

The purpose of highlighting these pages is to fuel the discussion for the next teaching point. The cadets may take home the guides and explore them further afterwards.

Teaching Point 2**Discuss Activities That Will Help Achieve a Healthy Lifestyle**

Time: 18 min

Method: Group Discussion

ACTIVITIES THAT HELP ACHIEVE A HEALTHY LIFESTYLE

Facilitate a discussion about activities that help achieve a healthy lifestyle, to include:

- activities that raise your heart rate;
- simple, everyday activities such as walking, skipping, running, raking leaves, skateboarding, etc.;
- playing physical games with friends/family; and
- options that do not cost money or require a gym membership.

Activities That Raise Your Heart Rate. This means any activity that gets your heart pumping. This would include walking, running, jumping, skateboarding, skiing, skating, tobogganing, swimming, biking, bowling, playing ball, raking leaves, shovelling snow, carrying groceries, joining a sports league, dancing, fitness classes (yoga, hip hop, aerobics, gymnastics), karate, judo, taking the stairs, etc.

Simple, Everyday Activities. Activities that can be done with little or no planning such as walking, skipping, running, raking leaves, mowing the lawn, gardening, skateboarding, rollerblading, ice skating, cycling, etc.

Playing Physical Games. Playing team games such as baseball, volleyball, soccer, football, hockey, etc. Gather some friends and encourage them to join in for some fun activity.

Options That Do Not Cost Money or Require a Gym Membership. Many of the activities listed above can be done at no cost to you. Being active is easily achievable without having to spend money or a great deal of time organizing an activity.



TIPS FOR ANSWERING/FACILITATING DISCUSSION

- Ask questions that help facilitate discussion; in other words, avoid questions with yes or no answers.
- Prepare questions ahead of time.
- Be flexible (you are not bound to only the prepared questions).
- Encourage cadets to participate by using praise such as “great idea” or “excellent response, can anyone add to that?”.
- Try to involve everyone by directing questions to non-participants.

SUGGESTED QUESTIONS TO ASK THE CADETS

- If they are active now and what activity they participate in.
- How often they are currently active.
- What physical benefits can be achieved through physical activity.
- What other benefits can be achieved (social, mental, etc.).
- What they enjoy about being active.



Do not let the discussion get off track. If the discussion veers in an undesired direction, simply redirect the discussion by returning to the prepared questions, or stating that the discussion needs to get back on track.

CONFIRMATION OF TEACHING POINT 2

QUESTIONS

- Q1. What are some of the physical benefits of physical activity?
- Q2. What are some of the social benefits of physical activity?
- Q3. What activities can help achieve a healthy lifestyle?

ANTICIPATED ANSWERS

- A1. Benefits include achieving a healthy weight, building strong bones and strengthening muscles, maintaining flexibility, promoting good posture and balance, improving fitness, strengthening the heart, increasing relaxation, and promoting healthy growth and development.
- A2. Meeting new friends, improving physical self-esteem.
- A3. Activities that can help achieve a healthy lifestyle include:
- activities that raise your heart rate;
 - simple, everyday activities such as walking, skipping, running, raking leaves, skateboarding, etc.; and
 - playing physical games with friends/family.



During the discussion, take notes on points that were raised and discussed by the group. At the end of the lesson, you will be able to recap the discussion.

END OF LESSON CONFIRMATION

The confirmation of this lesson will occur in EO M104.02 (Section 2) as the cadets develop a personal activity plan.

CONCLUSION

HOMEWORK/READING/PRACTICE

N/A.

METHOD OF EVALUATION

There is no formal assessment of this EO.

CLOSING STATEMENT

As physical fitness is one of the aims of the cadet program, it is important that cadets learn what activities contribute to an active lifestyle to help them achieve physical fitness.

INSTRUCTOR NOTES/REMARKS

N/A.

REFERENCES

- C1-011 (ISBN 0-662-32899) Minister of Health (2002). *Canada's Physical Activity Guide to Healthy Active Living* [Brochure].
- C3-024 (ISBN 0-7627-0476-4) Roberts, H. (1989). *Basic Essentials Backpacking*. Guildford, CT: The Globe Pequot Press.



COMMON TRAINING INSTRUCTIONAL GUIDE



SECTION 2

EO M104.02 – DEVELOP A PERSONAL ACTIVITY PLAN

Total Time:

30 min

INTRODUCTION

PRE-LESSON INSTRUCTIONS

A complete list of resources needed for the instruction of this EO is located at Chapter 2 of the QSP. Specific uses for said stores are identified throughout the Instructional Guide, within the teaching point for which they are required.

The instructor shall review the lesson content, and become familiar with the material prior to instruction of this lesson.

PRE-LESSON ASSIGNMENT

N/A.

APPROACH

For TP1 and TP2, the interactive lecture method was chosen as it allows the instructor to make a semi-formal presentation of the material where the cadets can participate by asking or responding to questions and commenting on the material. For this lesson, this method is most effective as it matches well the taxonomic level of the material and is age-appropriate by virtue of its participatory nature.

The practical activity in TP3 will verify the cadets' understanding of the material and will allow them to apply the knowledge acquired during the lesson. The cadets will complete the exercise under direction and supervision.

REVIEW

N/A.

OBJECTIVES

By the end of this lesson, the cadet will be expected to develop a personal activity plan.

IMPORTANCE

One of the aims of the air cadet program is physical fitness. In order to help the cadets achieve success in physical fitness, it is important to teach them how to set personal fitness goals and create an activity plan to help them achieve those goals.

Teaching Point 1**Explain How To Develop Goals**

Time: 8 min

Method: Interactive Lecture

DEFINITION OF A GOAL

The *Canadian Oxford Dictionary* defines a goal as the object of an ambition or effort, an aim.

SHORT- AND LONG-TERM GOALS

Short-term goals are smaller goals that work towards a long-term goal. For example, if your long-term goal was to run for 3 kilometres (km) in six months, a reasonable short-term goal would be to run for 1 kilometre in two months.

INDIVIDUAL AND TEAM GOALS

An individual can work towards achieving a goal, or a team can work towards achieving a common goal.

An individual goal is an aim or an ambition that one person strives to achieve. An individual goal is designed around the individual's abilities and personal expectations.

A team goal is an aim or ambition that a group of people work towards together to achieve. An example of a team goal could be walking across their province. The team would make a commitment to walk a predetermined amount of kilometres in a certain period of time. The team would keep track how many kilometres they have walked on their own and record their progress together on a map. As soon as the kilometres add up to the correct amount, the team has reached their goal.

HOW TO DEVELOP GOALS

Cadets should set a specific goal to work toward. The acronym SMART is a tool the cadets may find useful. The "S" of SMART stands for specific: the aim of the goal must be precisely defined. "M" stands for measurement: identify a standard with which to assess achievement. "A" stands for achievable: ensure needed resources are accessible for accomplishing the goal. "R" stands for relevant: ensure the goal is worthwhile for the cadet. "T" is for timing which represents the completion date of the goal. Ask the following questions to the cadets to help elicit SMART goals:

Specific. What specific activity can you do to help you reach your goal? Your goal should be concise and focused on one specific outcome (your goal cannot be too vague).

Measurable. How will you measure the achievement of the goal? What will you feel when the goal is achieved?

Achievable. What might hinder you as you progress toward the goal? What resources can you call upon?

Relevant. What will you get out of this?

Timing. When will you achieve this goal? What will be your first step?

CONFIRMATION OF TEACHING POINT 1

QUESTIONS

- Q1. What is the difference between short- and long-term goals?
- Q2. Explain individual and team goals.
- Q3. What does "SMART" stand for?

ANTICIPATED ANSWERS

- A1. Short-term goals are smaller goals that work towards a long-term goal.
- A2. An individual can work towards achieving a goal, or a team can work towards achieving a common goal.
- A3. Specific, Measurable, Achievable, Relevant, Timing.

Teaching Point 2**Explain How To Create a Personal Activity Plan**

Time: 8 min

Method: Interactive Lecture

CREATE AN ACTIVITY PLAN

Getting started is the hardest part. Creating an activity plan will help the cadet maintain focus and succeed at achieving set goals. An activity plan should meet the following criteria:

Activities That Will Help Achieve Set Goals. It is important to choose activities that will help the cadet achieve the goal(s) they have set for themselves. For instance, if the goal is to improve cardiovascular fitness, an appropriate activity would be one that builds up cardio stamina, e.g. start off running for one minute, then walking for one minute, and try working up to running for 10 minutes.

Moderate Activities and Vigorous Activities. Moderate activities would include activities like brisk walking, skating and biking. Vigorous activities would include running, weight training, basketball or soccer.

Fitting Your Lifestyle. Cadets should participate in activities at least once a week that fit their lifestyle. Activities that do not fit into their lifestyle will be difficult to carry out.

Simple Activities. Choosing simple activities that can be done with little planning will most likely carry the best results. When activities require a great deal of planning, it can become more of a chore than an activity or may become too difficult to follow through with.

CONFIRMATION OF TEACHING POINT 2**QUESTIONS**

- Q1. What are the two types of activities to choose from?
- Q2. What things should be considered when creating an activity plan?

ANTICIPATED ANSWERS

- A1. Vigorous and moderate activities.
- A2. Consider simple activities that will fit your lifestyle, and that will help achieve the goals that you have set for yourself.

Teaching Point 3**Have Cadets Create an Activity Plan**

Time: 9 min

Method: Individual Activity

CREATE AN ACTIVITY PLAN

Allow the cadets time to create their activity plans. This is to be done on an individual basis. An example of an activity plan is located in Annex A.



Allow the cadets to take their plan home to work on it further if desired. It is not mandatory that it be completed during this period.

END OF LESSON CONFIRMATION

End of lesson confirmation will take place as the cadets create their activity plans.

CONCLUSION

HOMEWORK/READING/PRACTICE

Cadets may take their plan home to work on it further if desired, as it is not mandatory that it be completed during this period.

METHOD OF EVALUATION

There is no formal assessment of this EO.

CLOSING STATEMENT

One of the aims of the air cadet program is physical fitness. In order to help the cadets achieve success in physical fitness, it is important to teach them how to set personal fitness goals and create an activity plan to help them achieve those goals.

INSTRUCTOR NOTES/REMARKS

N/A.

REFERENCES

- C0-019 (ISBN 0-7894-7147-7) Eaton, J., and Johnson, R. (2001). *Coaching Successfully*. New York: Dorling, Kindersley.
- C0-024 Barber, Katherine. (Ed.). (2001). *The Canadian Oxford Dictionary*. Don Mills: Oxford University Press.
- C1-011 (ISBN 0-662-32899) Minister of Health (2002). *Canada's Physical Activity Guide to Healthy Active Living* [Brochure].



COMMON TRAINING INSTRUCTIONAL GUIDE



SECTION 3

EO M104.03 – PARTICIPATE IN A DISCUSSION ON HYGIENIC PRACTICES DURING PHYSICAL ACTIVITY

Total Time:

30 min

INTRODUCTION

PRE-LESSON INSTRUCTIONS

A complete list of resources needed for the instruction of this EO is located at Chapter 2 of the QSP. Specific uses for said stores are identified throughout the Instructional Guide, within the teaching point for which they are required.

Prior to instructing this lesson the instructor shall:

- review the lesson content, and become familiar with the material;
- review TP1 of EO M104.02 (Section 2), which pertains to developing goals; and
- prepare questions for the group discussion.

PRE-LESSON ASSIGNMENT

N/A.

REVIEW

N/A.

OBJECTIVES

By the end of this lesson the cadets shall be expected to practice hygiene during physical activity.

APPROACH

The group discussion method was chosen to allow the cadets to share their knowledge, opinions, and feelings about the subject matter while still allowing the instructor to control the direction of the discussion. The instructor must ensure that points not brought forth by the class are presented. If the instructor follows the Instructional Guide, including the questions posed, this will allow the cadets to express, in their own words, what they learned from this lesson and how they may apply the information.

IMPORTANCE

As physical fitness is one of the aims of the cadet program, it is important that cadets adopt good hygiene practices when participating in physical activity.

Teaching Point 1**Lead a Discussion on Wearing Appropriate Clothing for Participating in Physical Activity**

Time: 15 min

Method: Group Discussion

CLOTHING

Loose-fitting clothing is best during exercise for freedom of movement. It should be comfortable and help the cadet feel self-assured.

As exercise generates a great amount of body heat, it is best to wear lighter clothes than what the temperature might actually indicate. In the summer, lighter coloured clothing will reflect the sun's rays and help you keep cool, and darker clothing is warmer in the winter. When the weather is very cold, it is better to wear several layers of light clothing than one or two heavy layers. The extra layers will maintain heat and can easily be shed if it becomes too warm.

The first layer is called the "core layer". This is the layer next to the skin. It should consist of a synthetic undershirt that is close fitting but not tight. It should be made of a material that will absorb perspiration and move it away from the skin.

The second layer should be loose fitting, but should keep the blood vessels of the neck and wrists protected and warm. It could consist of a zip-up top with a high neck or a shirt with a collar. Sleeves should be able to be rolled up and cuffs should be able to be buttoned. In hot weather, this layer may be used as an outside layer.

It is always best to wear something on your head, whether it is hot or cold outside. In the summer, a hat protects the head from the sun and provides shade, while in the winter a hat helps maintain warmth.

APPROPRIATE FOOT GEAR

Most importantly, properly fitting running shoes with arch support are necessary to ensure feet are not injured. Foot gear such as sandals or dress shoes are not appropriate for sporting activity, as they do not provide grip or support during movement.

Teaching Point 2**Participate in a Discussion on Hygiene During Physical Activity**

Time: 5 min

Method: Group Discussion

HYGIENE DURING PHYSICAL ACTIVITY

It is important to wear deodorant when participating in physical activity. Deodorant will help prevent any offensive body odour that may occur due to perspiration.

Start off any physical activity wearing clean clothing. Wearing dirty clothing may give an offensive odour and bother those around you. Clean clothing will give a fresh start to physical activity.



Do not let the discussion get off track. If the discussion veers in an undesired direction, simply redirect the discussion by returning to the prepared questions, or stating that the discussion needs to get back on track.

CONFIRMATION OF TEACHING POINT 2

QUESTIONS

- Q1. What can be worn to help avoid body odour?
- Q2. What should you start off wearing during physical activity?

ANTICIPATED ANSWERS

- A1. Deodorant.
- A2. Clean clothing.

Teaching Point 3

Participate in a Discussion on Hygiene After Physical Activity

Time: 10 min

Method: Group Discussion

HYGIENE AFTER PHYSICAL ACTIVITY

After physical activity, it is important to sponge bathe or shower in order to clean your body. Perspiration causes body odour that can only be cleaned with soap and water.

If showering is not possible immediately after physical activity, it is important to change damp or wet clothing and reapply deodorant. This will help prevent bacteria growth from perspiration, which causes body odour. It is a good idea to bring along a change of clothing if it is known ahead of time that showering facilities will not be available after a planned activity.

Clothing absorbs perspiration and odour so it needs to be washed before wearing it again.

CONFIRMATION OF TEACHING POINT 3

Confirmation of this lesson will occur as the cadets practice hygiene after physical activity.

END OF LESSON CONFIRMATION

The confirmation of this lesson will occur as the cadets participate in physical activities and practice hygiene.

CONCLUSION

HOMework/READING/PRACTICE

N/A.

METHOD OF EVALUATION

There is no formal assessment of this EO.

CLOSING STATEMENT

As physical fitness is one of the aims of the cadet program, it is important that cadets learn how to practice hygiene when participating in physical activity.

INSTRUCTOR NOTES/REMARKS

N/A.

REFERENCES

C0-026 Retrieved 19 April 2006, from Health <http://www.athealth.com/Consumer/disorders/FitnessFundamentals.html>.



COMMON TRAINING INSTRUCTIONAL GUIDE



SECTION 4

EO C104.01 – CREATE TEAM GOALS

Total Time:	30 min
-------------	--------

INTRODUCTION

PRE-LESSON INSTRUCTIONS

A complete list of resources needed for the instruction of this EO is located at Chapter 2 of the QSP. Specific uses for said stores are identified throughout the Instructional Guide, within the teaching point for which they are required.

Prior to instructing this lesson the instructor shall:

- review the lesson content, and become familiar with the material; and
- review TP1 of EO M104.02 (Section 2), which pertains to developing goals.

PRE-LESSON ASSIGNMENT

N/A.

REVIEW

Instructors shall review TP1 of EO M104.02 (Section 2).

OBJECTIVES

By the end of this lesson, the cadets will be expected to create team goals for their phase group.

APPROACH

The group discussion method was chosen to allow the cadets to share their knowledge, opinions, and feelings about the subject matter while still allowing the instructor to control the direction of the discussion. The instructor must ensure that points not brought forth by the class are presented. If the instructor follows the Instructional Guide, including the questions posed, this will allow the cadets to express, in their own words, what they learned from this lesson and how they may apply the information.

IMPORTANCE

As physical fitness is one of the aims of the cadet program, setting team goals will encourage participation in a variety of physical activities.

Teaching Point 1**Lead a Group Discussion Where the Cadets Are to Create Team Goals for the Year**

Time: 25 min

Method: Group Discussion

CREATE TEAM GOALS

Discuss with cadets what goals they may wish to achieve together as a team. Cadets may choose a goal that can be worked on as individuals and tracked as a group (collecting kilometres to walk across the city, province, country, etc.) or a goal that is to be worked on together (playing team sports twice a month together as a group). Their team goal should include short-term goals that work toward a long-term goal. The cadets are required to record their team goal and create a chart to track their progress.

Suggested types of activities:

- Learn a new physical skill together.
- Time – exercise for 100 hours.
- Participate in a skip-a-thon (could even collect sponsors and raise money for the squadron).
- Heart rate – improve resting heart rate as a group (before and after).
- Improve cardiovascular endurance (before and after).



The cadets should brainstorm ideas while the instructor records their ideas on an OHP or whiteboard. Each idea would then be discussed (pros, cons, etc.) to decide which goal would be best for the group.

CONFIRMATION OF TEACHING POINT 1

Confirmation of this teaching point will occur as the cadets participate in the group discussion.



During the discussion, take notes on points that were raised and discussed by the group. At the end of the lesson, you will be able to recap the discussion.

END OF LESSON CONFIRMATION

The confirmation of this lesson will occur as the cadets work together as a team to meet their common long-term goal.

CONCLUSION**HOMEWORK/READING/PRACTICE**

N/A.

METHOD OF EVALUATION

There is no formal assessment of this EO.

CLOSING STATEMENT

As physical fitness is one of the aims of the cadet program, it is important that cadets learn how to work as a team in order to achieve a common goal. This is a fun way to promote physical fitness and teamwork.

INSTRUCTOR NOTES/REMARKS

N/A.

REFERENCES

C1-011 (ISBN 0-662-32899) Minister of Health (2002). *Canada's Physical Activity Guide to Healthy Active Living* [Brochure].

THIS PAGE INTENTIONALLY LEFT BLANK

EXAMPLE OF AN ACTIVITY PLAN

Goal: To be able to run for 20 minutes.

- **Specific.** I want to be able to run for 20 minutes continuously.
- **Measurable.** I will keep track of my running progress every week. When the goal is completed, I will feel great for achieving my goal.
- **Achievable.** Possible hindrances – weather, injuries. No resources are needed for this goal because I can run outside.
- **Relevant.** I will improve my cardiovascular fitness and endurance.
- **Timing.** I will achieve this goal in 11 weeks by continuously walking and running for a total of 20 minutes, until I can run for 20 minutes straight.

ACTIVITY SCHEDULE

Week 1. Run 1 minute, walk 1 minute continuously for 20 minutes, 3 x per week.

Week 2. Run 2 minutes, walk 1 minute, continuously for 20 minutes, 3 x per week.

Week 3. Run 3 minutes, walk 1 minute, continuously for 20 minutes, 3 x per week.

Week 4. Run 4 minutes, walk 1 minute, continuously for 20 minutes, 3 x per week.

Week 5. Run 5 minutes, walk 1 minute, continuously for 20 minutes, 3 x per week.

Week 6. Run 6 minutes, walk 1 minute, continuously for 20 minutes, 3 x per week.

Week 7. Run 7 minutes, walk 1 minute, continuously for 20 minutes, 3 x per week.

Week 8. Run 8 minutes, walk 1 minute, continuously for 20 minutes, 3 x per week.

Week 9. Run 9 minutes, walk 1 minute, continuously for 20 minutes, 3 x per week.

Week 10. Run 10 minutes, walk 1 minute, continuously for 20 minutes, 3 x per week.

Week 11. Run for 20 minutes continuously.

THIS PAGE INTENTIONALLY LEFT BLANK

CHAPTER 5

PO 105 – PARTICIPATE IN RECREATIONAL SPORTS



COMMON TRAINING INSTRUCTIONAL GUIDE



SECTION 1

EO M105.01 – PARTICIPATE IN ORGANIZED RECREATIONAL TEAM SPORTS

Total Time:

3 Sessions or 1 Day

INTRODUCTION

PRE-LESSON INSTRUCTIONS

A complete list of resources needed for the instruction of this EO is located at Chapter 2 of the QSP. Specific uses for said stores are identified throughout the Instructional Guide, within the teaching point for which they are required.

Prior to instructing this lesson the instructor shall:

- review the lesson content, and become familiar with the material;
- determine what sport is to be played;
- consider the participant (age, skill level and physical condition of all members as these factors may play a role in injuries and injury prevention);
- consider the environment (ensure suitable for the chosen sport);
- ensure equipment for the sport is available;
- ensure a first aid station is set up;
- take into account the equipment and facilities which are readily available to the squadron; and
- ensure cadets are made aware prior to arriving to bring or wear proper sports attire.

PRE-LESSON ASSIGNMENT

Cadets are to bring appropriate sports attire.

APPROACH

The participation method was chosen for this lesson as it allows the cadets to engage freely in the activity. The cadets should be encouraged to interact with all other group members. The instructor must foster an environment that involves the contributions of all cadets, regardless of their skill level. This methodology requires adequate supervision by senior cadets and adult staff.

REVIEW

N/A.

OBJECTIVES

By the end of this lesson the cadet shall be expected to:

- demonstrate a basic understanding of the specific sport's rules and regulations;
- actively participate in a warm up;
- actively participate in organized team sports; and
- actively participate in a cool down.

IMPORTANCE

It is important for youth to be active in order to promote a healthy, physically active lifestyle. By participating in organized recreational team sports, the cadets are given the opportunity to be active in a team environment.

Teaching Point 1

Introduce Cadets to a Specific Sport's Rules and Regulations

Time: 10 min

Method: Interactive Lecture

HOW TO PLAY THE SPORT

The overview of how to play the sport will differ for each sport listed in the CCO's list of approved sports. Once the instructor has chosen the sport to be played, they should refer to [Annex B](#) for a full overview of how to play.

RULES AND REGULATIONS

The rules and regulations of each sport will differ. Once the instructor has chosen the sport to be played, they should refer to [Annex B](#) for an overview of the rules and regulations of the sport.

CONFIRMATION OF TEACHING POINT 1

QUESTIONS

- Q1. How many players per team?
- Q2. What are the general rules and regulations to be followed?

ANTICIPATED ANSWERS

- A1. Answer will be dependent on the sport played and can be found in [Annex B](#).
- A2. Answer will be dependent on the sport played and can be found in [Annex B](#).

Teaching Point 2

Participate in a Warm Up

Time: 10 min

Method: Participation

PURPOSE OF A WARM UP

A warm up will be composed of light cardiovascular activities designed to:

- stretch the muscles and ligaments;
- gradually increase respiratory action and heart rate;

- expand the muscles' capillaries to accommodate the increase in blood circulation which occurs during physical activity; and
- raise muscle temperature to facilitate reactions in muscle tissue.

FACTORS TO REMEMBER WHILE STRETCHING

The following factors are important to remember while stretching in order to get ready for physical activity and to help prevent injury:

- Stretch all major muscle groups, including your back, chest, legs, and shoulders.
- Never bounce when stretching.
- Hold each stretch for up to 30 seconds to let the muscles release fully.
- Repeat each stretch two to three times.
- When holding a stretch, support your limbs at the joint.
- Static stretching, which is stretching a muscle and holding it in this position without discomfort for 10 to 30 seconds, is considered the safest method of stretching.
- Stretching helps to relax your muscles and improves flexibility, which is the range of movement about your joints.
- As a guide, allow 10 minutes of pre-exercise stretching for every one hour of exercise.



The stretches used should focus on the areas of the body that will be used the most during the given sport.

ACTIVITY

Time: 9 min

OBJECTIVE

The purpose of the warm up is to stretch and do light cardiovascular activity to get the body ready for physical activity and to help prevent injury.

RESOURCES

- Gym mats (if available).
- Area large enough for all cadets.

ACTIVITY LAYOUT

- Dependent on numbers, position cadets so that they can see the instructor demonstrate each movement (as per Figure 5-1-1 or 5-1-2). It would be helpful, if possible, to have assistant instructors that can help in demonstrating the movements and ensuring the cadets are performing them properly.
- Have cadets spread out with at least two arm lengths between them.

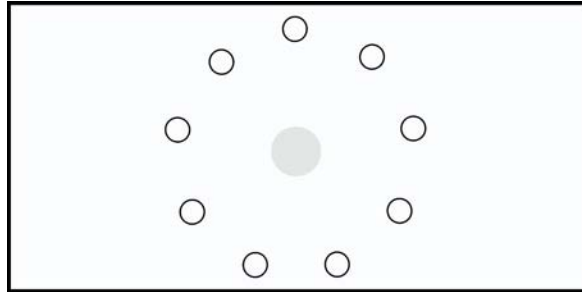

Figure 5-1-1 Instructor in Centre of Warm Up Circle

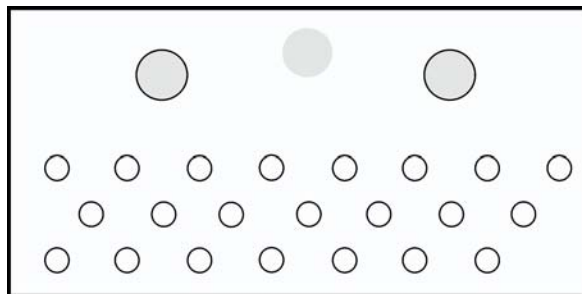

Figure 5-1-2 Instructor at Front With Assistant Instructors

SAFETY

- Ensure there is adequate space between the cadets for them to move freely.
- Ensure the cadets perform the stretches and light cardiovascular activities in a manner that is safe, following the guidelines listed above.

INSTRUCTOR GUIDELINES

- Demonstrate each stretch and light cardiovascular activity.
- If assistant instructors are present, brief them as to the manner of the activities and how to ensure the cadets are performing them in a safe manner.
- Have knowledge of what activities are safe and how to prevent injuries from occurring.
- Assess and supervise as each movement is completed to ensure a cadet is not doing them improperly in a manner which may cause injury.



Some sample stretches can be found at [Annex C](#). These are samples only and should not be considered an exhaustive list.

CONFIRMATION OF TEACHING POINT 2

QUESTIONS

Q1. How long should a stretch be held for?

Q2. What is the purpose of performing light cardiovascular activity before participating in physical activity?

ANTICIPATED ANSWERS

A1. Approximately 10 to 30 seconds.

A2. To gradually increase respiratory action and heart rate and to raise the muscle temperature to facilitate reactions in muscle tissue.

Teaching Point 3

Participate in a Given Sports Activity

Time: 240 min

Method: Participation

PARTICIPATE IN A GIVEN SPORT

In accordance with the rules and regulations, the cadets shall participate in a given sport from the CCO's list of approved sports.



- Sports are to be chosen from the CCO's list of approved sports, which can be found at [Annex A](#).
- The instructor should ensure safety at all times throughout the duration of the activity.

ACTIVITY

Time: 240 min

OBJECTIVE

- Demonstrate a basic understanding of the specific sport's rules and regulations.
- Actively participate in organized team sports.

RESOURCES

- Sports equipment required for the given sport.
- Safety equipment required for the given sport.
- Whistle.
- Stopwatch.
- First aid equipment.

ACTIVITY LAYOUT

- Prior to the commencement of the organized team sport, set-up the sporting venue for the chosen sport.
- Break cadets into even teams.
- Choose a timekeeper to keep the time.
- Choose a scorekeeper to keep the score.
- Choose a referee to call plays as necessary.

- A referee will have an auditory device, such as a whistle, to call plays as necessary.
- Upon completion of the game, the winner will be declared.



Minor changes may have to be made to the set-up of the sport dependent upon the resources and facilities available.

SAFETY

- Ensure cadets are aware of the rules and regulations.
- Supervise at all times throughout the conduct of the activity.
- Ensure a first aid station is set up and all personnel made aware of where it is.
- Ensure a first aider is identified at the beginning of the activity and is available at all times.

INSTRUCTOR GUIDELINES

- Must be in the sporting venue at all times throughout the conduct of the activity.
- Shall have a whistle, or other sound device, in which to stop play when necessary.
- Should make use of assistant instructors, other senior cadets, or officers, to assist in supervision.

Teaching Point 4

Participate in a Cool Down

Time: 10 min

Method: Participation

PURPOSE OF A COOL DOWN

A cool down will be composed of light cardiovascular activities meant to allow the body time to slowly recover from physical activity and to help prevent injury. Cool downs:

- prepare the respiratory system to return to its normal state; and
- stretch muscles and ligaments to help relax them and restore them to their resting length.

FACTORS TO REMEMBER WHILE STRETCHING

The following factors are important to remember while stretching in order to recover from physical activity and to help prevent injury:

- Stretch all major muscle groups, including your back, chest, legs and shoulders.
- Never bounce when stretching.
- Hold each stretch for up to 30 seconds to let the muscles release fully.
- Repeat each stretch two to three times.
- When holding a stretch, support your limbs at the joint.
- Static stretching, which is stretching a muscle and holding it in this position without discomfort for 10 to 30 seconds, is considered the safest method of stretching.

- Stretching helps to relax your muscles and restore them to their resting length, and improves flexibility, which is the range of movement about your joints.
- As a guide, allow 10 minutes of post-exercise stretching for every one hour of exercise.



The stretches used should focus on the areas of the body that were used the most during the sports activity.

ACTIVITY

Time: 9 min

OBJECTIVE

The purpose of the cool down is to stretch and do light cardiovascular activity to allow the body time to recover from physical activity and to help prevent injury.

RESOURCES

- Gym mats (if available).
- Area large enough for all cadets.

ACTIVITY LAYOUT

- Dependent on numbers, position cadets so that they can see the instructor as he or she demonstrates each movement (as per Figure 5-1-3 or 5-1-4). It would be helpful, if possible, to have assistant instructors that can help in demonstrating the movements and ensuring the cadets are performing them properly.
- Have cadets spread out with at least two arm lengths between them.

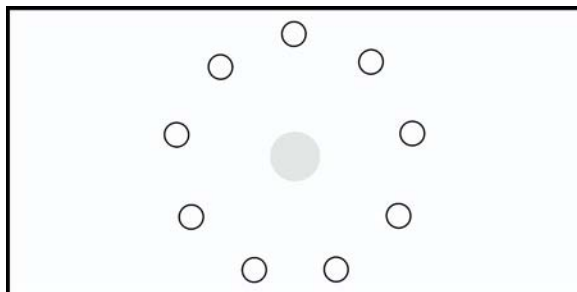

Figure 5-1-3 Instructor in Centre of Cool Down Circle

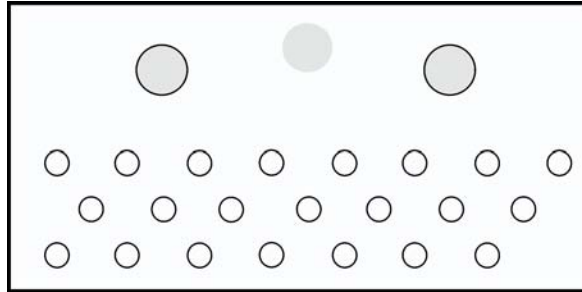

Figure 5-1-4 Instructor at Front With Assistant Instructors

SAFETY

- Ensure there is adequate space between cadets for them to move freely.
- Ensure the cadets perform the stretches and light cardiovascular activities in a manner that is safe, following the guidelines listed above.

INSTRUCTOR GUIDELINES

- Demonstrate each stretch and light cardiovascular activity.
- If assistant instructors are present, brief them as to the manner of the activities and how to ensure the cadets are performing them in a safe manner.
- Have knowledge of what activities are safe and how to prevent injuries from occurring.
- Assess and supervise as each movement is completed to ensure a cadet is not doing them improperly in a manner, which may cause injury.



Some sample stretches can be found at [Annex C](#). These are samples only and should not be considered an exhaustive list.

CONFIRMATION OF TEACHING POINT 4

QUESTIONS

Q1. What is the purpose of performing a cool down?

ANTICIPATED ANSWERS

A1. To prepare the respiratory and cardiovascular systems to return to their normal state and to stretch the muscles and ligaments to help relax them and restore them to their resting length.

END OF LESSON CONFIRMATION

Cadets will be supervised throughout the duration of the sports event. The focus shall be on the cadets' participation.

CONCLUSION

HOMework/READING/PRACTICE

N/A.

METHOD OF EVALUATION

There is no formal assessment of this EO. Cadets will be supervised throughout the duration of the sports event.

CLOSING STATEMENT

Every cadet in year one training should be given the opportunity to participate in organized recreational team sports. There should be no focus on competition at this level; rather, the cadets should be focused on participating and demonstrating sportsmanship as a member of a team.

INSTRUCTOR NOTES/REMARKS

The overall objective is for cadets to participate in nine periods of organized sports. This can be broken down in two ways. It can be carried out over three training sessions, where cadets can participate in the same sport, or a different sport, on each night. If done on three nights, cadets are to be introduced to the sport to be played, participate in a warm up, activity, and cool down on each night. If carried out as a training day, cadets are to be introduced to the sport or sports to be played, then are to participate in a warm up, a series of activities, and a cool down.

REFERENCES

- C0-001 (ISBN 0-88011-807-5) Human Kinetics with Thomas Hanlon. (1998). *The Sports Rules Book: Essential Rules for 54 Sports*. USA: Human Kinetics Publishers, Inc.
- C0-002 (ISBN 0-88962-630-8) LeBlanc, J., and Dickson, L. (1997). *Straight Talk About Children and Sport: Advice for Parents, Coaches, and Teachers*. Oakville, ON and Buffalo, NY: Mosaic Press.
- C0-030 Ringette Canada. Retrieved 27 April 2006, from www.ringette.ca.
- C0-031 Ultimate. Retrieved 27 April 2006, from www.whatisultimate.com.
- C0-032 Stanford Intramurals, Department of Athletics, Physical Education and Recreation. Retrieved 30 April 2006, from www.stanford.edu/group/Intramurals/kickballrules.html.
- C0-033 Slam Sports (2006). Retrieved 30 April 2006, from www.slam.canoe.ca/FlagFootball/Rules/home.html.
- C0-034 Ultimate Players Association (2000-2005). Retrieved 27 April 2006, from www.upa.org/ultimate.
- C0-035 World Adult Kickball Association (1998-2006). Retrieved 1 May 2006, from www.kickball.com.
- C0-036 Women's Heart Foundation (1999-2000). Retrieved 25 April 2006, from www.womensheart.org/content/Exercise/stretching_exercise.asp.
- C0-037 Walkablock Club of America (2005). Retrieved 25 April 2006, from www.walkablock.com/stretch2.gif.
- C0-038 Shelter Online (2006). Retrieved 25 April 2006, from www.shelterpub.com/_fitness/online_stretches.gif.
- C0-039 Retrieved 25 April 2006, from www.eeshop.unl.edu.

- C0-040 Lose the Back Pain (2006). Retrieved 25 April 2006, from www.losethebackpain.com.
- C0-041 Roadcycling (2006). Retrieved 25 April 2006, from www.roadcycling.com/artman/upload/stretch.jpg.
- C0-042 Spine Universe. Retrieved 25 April 2006, from www.spineuniverse.com.



COMMON TRAINING INSTRUCTIONAL GUIDE



SECTION 2

EO C105.01 – PARTICIPATE IN AN ORGANIZED SPORTS TABLOID

Total Time:

3 Sessions or 1 Day

INTRODUCTION

PRE-LESSON INSTRUCTIONS

A complete list of resources needed for the instruction of this EO is located at Chapter 2 of the QSP. Specific uses for said stores are identified throughout the Instructional Guide, within the teaching point for which they are required.

Prior to instructing this lesson the instructor shall:

- review the lesson content, and become familiar with the material;
- determine what events are to be incorporated into the tabloid;
- determine how many participants are expected as this will affect the number of events needed;
- consider the participant (age, skill level, and physical condition of all members as these factors may play a role in injuries and injury prevention);
- consider the environment (ensure it is suitable for the chosen activities);
- ensure equipment for the events are available; and
- ensure cadets are made aware prior to arriving to bring or wear proper sports attire.

PRE-LESSON ASSIGNMENT

Cadets are to bring appropriate sports attire.

APPROACH

The participation method was chosen for this lesson as it allows the cadets to engage freely in the activity. The cadets should be encouraged to interact with all other group members. The instructor must foster an environment that involves the contributions of all cadets, regardless of their skill level. This methodology requires adequate supervision by senior cadets and adult staff.

REVIEW

N/A.

OBJECTIVES

By the end of this lesson the cadet shall be expected to:

- actively participate in a warm up;
- actively participate in an organized sports tabloid;
- actively participate in a cool down; and
- demonstrate good sportsmanship.

IMPORTANCE

The sports tabloid allows cadets to participate in a variety of activities:

- It is an effective and enjoyable manner of involving a large number of cadets in low-level competition.
- Is motivation for the lower-level or average-level performers to participate.
- A large number of personnel can participate in activities at one time.
- One event can provide personnel participation in a wide variety of activities.
- Can be designed around already existing facilities and equipment.
- Emphasis is placed on team effort rather than individual high performance by a cadet.

Teaching Point 1

Introduction to Sports Tabloid Rules and Regulations

Time: 10 min

Method: Interactive Lecture

RULES AND REGULATIONS

The rules and regulations to be used for a sports tabloid will vary depending upon the squadron and the facilities available to them. Some considerations to take into account include the following:

- Competitors must rotate through events in a pre-arranged fashion – a diagram of stations can be displayed or signs with station numbers can be put at each station.
- A whistle, or other such signalling device, should be used to commence and complete each event, as well as to tell cadets when to rotate stations.
- Describe standards to be met at each event (how many points for achievement, etc.) – this may be done at the beginning as an overview if the tabloid is fairly small, or time can be given at the beginning of each event for the scorekeeper to brief each team on the station before they participate in the activity.
- There must be a runner for each team to bring their score from each station to the master scorer.
- Time should be given at the beginning of each station for the scorekeeper to give a demonstration of how the event should take place.

CONFIRMATION OF TEACHING POINT 1

QUESTIONS

Q1. Describe how teams are to rotate from event to event.

ANTICIPATED ANSWERS

A1. Teams are to rotate in the pre-arranged fashion according to some type of sounding device.

Teaching Point 2**Participate in a Warm Up**

Time: 10 min

Method: Participation

PURPOSE OF A WARM UP

A warm up will be composed of light cardiovascular activities designed to:

- stretch the muscles and ligaments;
- gradually increase respiratory action and heart rate;
- expand the muscles' capillaries to accommodate the increase in blood circulation which occurs during physical activity; and
- raise muscle temperature to facilitate reactions in muscle tissue.

FACTORS TO REMEMBER WHILE STRETCHING

The following factors are important to remember while stretching in order to get ready for physical activity and to help prevent injury:

- Stretch all major muscle groups, including your back, chest, legs and shoulders.
- Never bounce when stretching.
- Hold each stretch for up to 30 seconds to let the muscles release fully.
- Repeat each stretch two to three times.
- When holding a stretch, support your limbs at the joint.
- Static stretching, which is stretching a muscle and holding it in this position without discomfort for 10 to 30 seconds, is considered the safest method of stretching.
- Stretching helps to relax your muscles and improve flexibility, which is the range of movement about your joints.
- As a guide, allow 10 minutes of pre-exercise stretching for every one hour of exercise.

ACTIVITYTime: 9 min

OBJECTIVE

The purpose of the warm up is to stretch and do light cardiovascular activity to get the body ready for physical activity and to help prevent injury.

RESOURCES

- Gym mats (if available).
- Area large enough for all cadets.

ACTIVITY LAYOUT

- Dependent on numbers, position cadets so that they can see the instructor demonstrate each movement (as per Figure 5-2-1 or 5-2-2). It would be helpful, if possible, to have assistant instructors that can help in demonstrating the movements and ensuring the cadets are performing them properly.
- Have cadets spread out with at least two arm lengths between them.

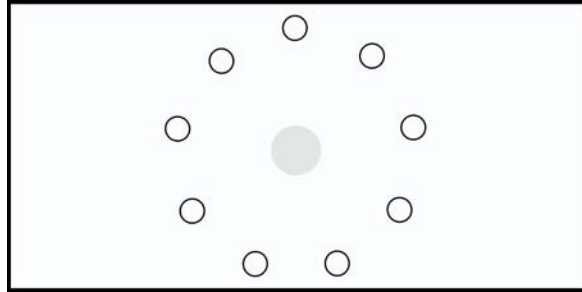

Figure 5-2-1 Instructor in Centre of Warm Up Circle

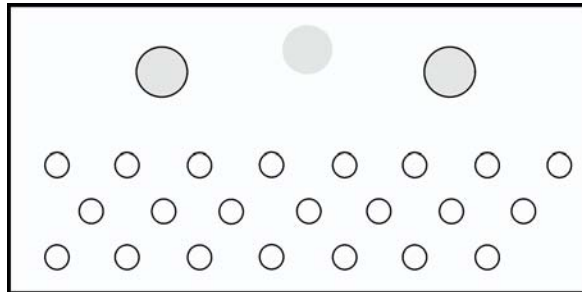

Figure 5-2-2 Instructor at Front With Assistant Instructors

SAFETY

- Ensure the cadets are spread out enough that they are not in each other's way.
- Ensure the cadets perform the stretches and light cardiovascular activities in a manner that is safe, following the guidelines listed above.

INSTRUCTOR GUIDELINES

- Demonstrate each stretch and light cardiovascular activity.
- If assistant instructors are present, brief them as to the manner of the activities and how to ensure the cadets are performing them in a safe manner.
- Have knowledge of what activities are safe and how to prevent injuries from occurring.
- Assess and supervise as each movement is completed to ensure a cadet is not doing them improperly in a manner which may cause injury.



Some sample stretches can be found at Annex C. These are samples only and should not be considered an exhaustive list.

CONFIRMATION OF TEACHING POINT 2

QUESTIONS

- Q1. How long should a stretch be held for?
- Q2. What is the purpose of performing light cardiovascular activity before participating in physical activity?

ANTICIPATED ANSWERS

- A1. Approximately 10 to 30 seconds.
- A2. To gradually increase respiratory action and heart rate and to raise the muscle temperature to facilitate reactions in muscle tissue.

Teaching Point 3**Participate in an Organized Sports Tabloid**

Time: 240 min

Method: Participation

PARTICIPATE IN AN ORGANIZED SPORTS TABLOID

In accordance with the rules and regulations, cadets should participate actively in an organized sports tabloid.



Activities may be taken from the sample list provided at Annex D or can be made up to suit the squadron's equipment and facilities which are available to them.



The instructor should ensure safety at all times throughout the conduct of the sports tabloid.

ACTIVITY

Time: 240 min

OBJECTIVE

To allow cadets to actively participate in an organized sports tabloid. The sports tabloid allows a larger number of cadets to participate at the same time in low-level competition. It also gives the lower or average-level performers motivation to participate as the emphasis is on team performance rather than individual skill or high-performance by an individual cadet.

RESOURCES

- Suggested activity/equipment list.
- Safety equipment, as necessary.
- First aid equipment.
- Tables (x number of stations, if required).

- Whistle (or other auditory signalling device).
- Stopwatch.
- Master score sheet (sample can be found at Annex G).
- Stations score sheets (sample can be found at Annex F).
- Station number posters (8 in. x 11 in. sheet of paper with numbers on them to be placed at stations for identification).
- Tape.



See Annexes D and E.

ACTIVITY LAYOUT

- Prior to the commencement of the sport tabloid, set up the activity area, similar to Figure 5-2-3.
- Break cadets into teams evenly.
- Send each team to a station.
- If required, station scorekeepers will have a specific amount of time to demonstrate the activity at their station.
- Upon a sound signal, stations will start the activity.
- A timekeeper/master scorekeeper will time each event.
- Upon a sound signal, teams will stop the activity and sit down at their station.
- Station scorekeepers will complete the tally and give it to a runner to take to the master scorekeeper.
- When the master scorekeeper has tallied all team scores, a sound signal will be given for teams to rotate to the next station.
- Teams will progress to the next station and get a demonstration of the activity at that station, if required.
- Teams will continue in this fashion, until they have completed all the stations.
- Upon completion of the tabloid, the master scorekeeper will complete the final tally.
- Winners are determined and announced.

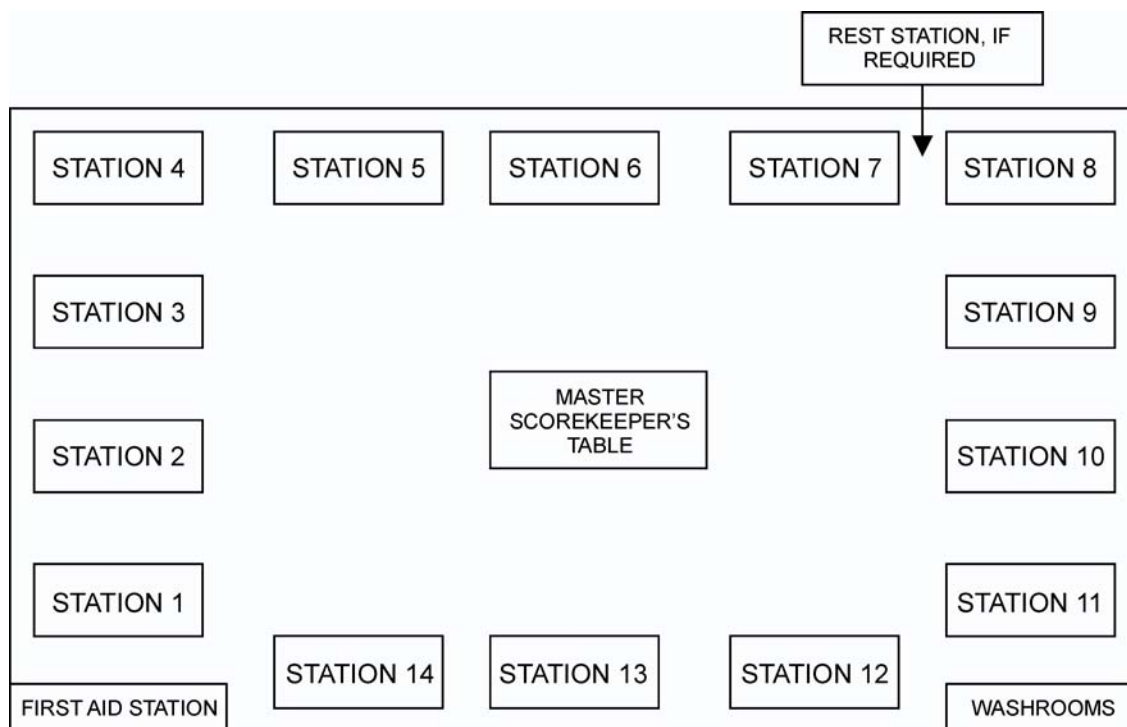

Figure 5-2-3 Sample Tabloid Set-up



Minor changes may have to be made to the set-up of the tabloid area dependent upon the resources and facilities available.

SAFETY

- Ensure cadets are aware of the proper rules and regulations.
- Supervise at all times throughout the conduct of the activity.
- Ensure a first aid station is set up and all personnel are made aware of where it is.
- Ensure a first aider is identified at the beginning of the activity and is available at all times.

INSTRUCTOR GUIDELINES

- Must be in the sporting venue at all times throughout the conduct of the activity.
- Shall have a whistle, or other auditory device, in which to stop play when necessary.
- A timekeeper must ensure timings are followed at each station and give a sound signal to start and stop each event.
- Should make use of assistant instructors, other senior cadets, or officers, to assist in supervision. This is easily done during a sports tabloid as it is necessary to have scorekeepers at each station who can be briefed on all safety regulations and assist in overall supervision of the cadets.

Teaching Point 4**Participate in a Cool Down**

Time: 10 min

Method: Participation

PURPOSE OF A COOL DOWN

A cool down will be composed of light cardiovascular activities meant to allow the body time to slowly recover from physical activity and to help prevent injury. Cool downs:

- prepare the respiratory system to return to its normal state; and
- stretch muscles and ligaments to help relax them and restore them to their resting length.

FACTORS TO REMEMBER WHILE STRETCHING

The following factors are important to remember while stretching in order to recover from physical activity and to help prevent injury:

- Stretch all major muscle groups, including your back, chest, legs and shoulders.
- Never bounce when stretching.
- Hold each stretch for up to 30 seconds to let the muscles release fully.
- Repeat each stretch two to three times.
- When holding a stretch, support your limbs at the joint.
- Static stretching, which is stretching a muscle and holding it in this position without discomfort for 10 to 30 seconds, is considered the safest method of stretching.
- Stretching helps to relax your muscles and restore them to their resting length, and improves flexibility, which is the range of movement about your joints.
- As a guide, allow 10 minutes of post-exercise stretching for every one hour of exercise.

ACTIVITYTime: 9 min

OBJECTIVE

The purpose of the cool down is to stretch and do light cardiovascular activity to allow the body time to recover from physical activity and to help prevent injury.

RESOURCES

- Gym mats (if available).
- Area large enough for all cadets.

ACTIVITY LAYOUT

- Dependent on numbers, position cadets so that they can see the instructor as they demonstrate each movement (as per Figure 5-2-4 or 5-2-5). It would be helpful, if possible, to have assistant instructors that can help in demonstrating the movements and ensuring the cadets are performing them properly.
- Have cadets spread out with at least two arm lengths between them.

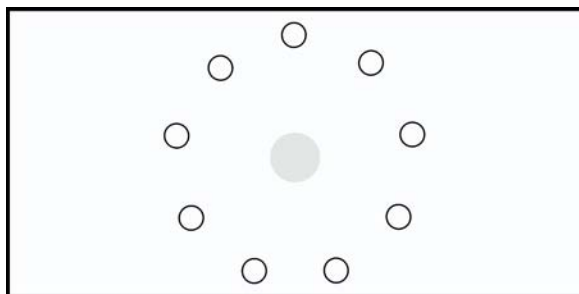

Figure 5-2-4 Instructor in Centre of Cool Down Circle

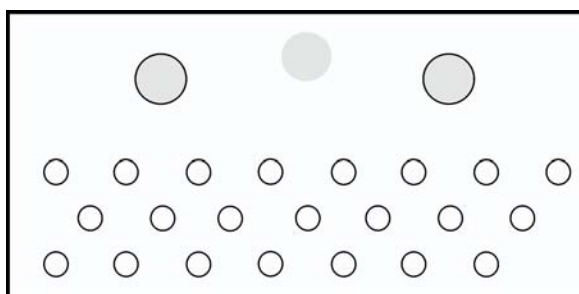

Figure 5-2-5 Instructor at Front With Assistant Instructors

SAFETY

- Ensure there is adequate space between cadets for them to move freely.
- Ensure the cadets perform the stretches and light cardiovascular activities in a manner that is safe, following the guidelines listed above.

INSTRUCTOR GUIDELINES

- Properly demonstrate each stretch and light cardiovascular activity.
- If assistant instructors are present, brief them as to the manner of the activities and how to ensure the cadets are performing them in a safe manner.
- Have knowledge of what activities are safe and how to prevent injuries from occurring.
- Assess and supervise as each movement is completed to ensure a cadet is not doing them improperly in a manner which may cause injury.



Some sample stretches can be found at Annex C. These are samples only and should not be considered an exhaustive list.

CONFIRMATION OF TEACHING POINT 4

QUESTIONS

- Q1. What is the purpose of performing a cool down?

ANTICIPATED ANSWERS

- A1. To prepare the respiratory and cardiovascular systems to return to their normal state and to stretch the muscles and ligaments to help relax the muscles and restore them to their resting length.

END OF LESSON CONFIRMATION

Cadets will be supervised throughout the conduct of the sports tabloid. The focus shall be on the cadets' participation and ability to act as a member of a team.

CONCLUSION

HOMEWORK/READING/PRACTICE

N/A.

METHOD OF EVALUATION

There is no formal assessment of this EO. Cadets will be supervised throughout the conduct of the sports tabloid.

CLOSING STATEMENT

Every cadet in year one training may be given the opportunity to participate in an organized sports tabloid. There should be no focus on competition at this level; rather, the cadets should be focused on participating and demonstrating sportsmanship as a member of a team.

INSTRUCTOR NOTES/REMARKS

The overall objective is for cadets to participate in nine periods of sports tabloid events. This can be carried out in two ways, if chosen as part of the complementary training package. Three complete training sessions or a full training day can be used to complete this event.

REFERENCES

- C0-002 (ISBN 0-88962-630-8) LeBlanc, J., and Dickson, L. (1997). *Straight Talk About Children and Sport: Advice for Parents, Coaches, and Teachers*. Oakville, ON and Buffalo, NY: Mosaic Press.
- C0-036 Women's Heart Foundation (1999-2000). Retrieved 25 April 2006, from www.womensheart.org/content/Exercise/stretching_exercise.asp.
- C0-037 Walkablock Club of America (2005). Retrieved 25 April 2006, from www.walkablock.com/stretch2.gif.
- C0-038 Shelter Online (2006). Retrieved 25 April 2006, from www.shelterpub.com/_fitness/online_stretches.gif.
- C0-039 Retrieved 25 April 2006, from www.eeshop.unl.edu.
- C0-040 Lose the Back Pain (2006). Retrieved 25 April 2006, from www.losethebackpain.com.
- C0-041 Roadcycling (2006). Retrieved 25 April 2006, from www.roadcycling.com/artman/upload/stretches.jpg.
- C0-042 Spine Universe. Retrieved 25 April 2006, from www.spineuniverse.com.



COMMON TRAINING INSTRUCTIONAL GUIDE



SECTION 3

EO C105.02 – PARTICIPATE IN AN ORGANIZED INTRAMURAL SPORTS EVENT

Total Time:

3 Sessions or 1 Day

INTRODUCTION

PRE-LESSON INSTRUCTIONS

A complete list of resources needed for the instruction of this EO is located at Chapter 2 of the QSP. Specific uses for said stores are identified throughout the Instructional Guide, within the teaching point for which they are required.

Prior to instructing this lesson the instructor shall:

- review the lesson content, and become familiar with the material;
- determine what sport(s) are to be played dependent on the number of expected participants;
- organize a timetable and distribute it to all participants;
- consider the participant (age, skill level, and physical condition of all members as these factors may play a role in injuries and injury prevention);
- consider the environment (suitable environment for the chosen sport);
- ensure equipment for event(s) is available;
- consider the type of tournament – the type of tournament to be held will directly affect how winners will be defined;
- determine the type of tournament based on Annex H; and
- ensure cadets are made aware prior to arriving to bring or wear proper sports attire.

PRE-LESSON ASSIGNMENT

Cadets are to bring appropriate sports attire.

APPROACH

The participation method was chosen for this lesson as it allows the cadets to engage freely in the activity. The cadets should be encouraged to interact with all other group members. The instructor must foster an environment that involves the contributions of all cadets, regardless of their skill level. This methodology requires adequate supervision by senior cadets and adult staff.

REVIEW

N/A.

OBJECTIVES

By the end of this lesson the cadet shall be expected to:

- demonstrate a basic understanding of the sport's rules and regulations;
- actively participate in a warm up;
- actively participate in organized intramural sports; and
- actively participate in a cool down.

IMPORTANCE

It is important for today's youth to be active and to learn how to act as a member of a team. By playing organized intramural sports, the cadets are given the opportunity to participate in something that contributes to a healthy, physically active lifestyle.

Teaching Point 1

Introduce Cadets to a Specific Sport and Its Rules and Regulations

Time: 5 min

Method: Interactive Lecture

OVERVIEW OF HOW TO PLAY THE SPORT(S)

The overview of how to play the sport(s) will differ for each sport listed in the Canadian Cadet Movement's list of approved sports, found at Annex A. Once the instructor has chosen the sport(s) to be played, they should refer to Annex B for a full overview of how to play.

RULES AND REGULATIONS

The rules and regulations of each sport will differ. Once the instructor has chosen the sport(s) to be played, they should refer to Annex B, for a full overview of the rules and regulations of the sport(s). Dependent upon the level of competition, only the rules and regulations determined necessary to play to that level will have to be given to the cadets.

Teaching Point 2

Introduce Cadets to the Procedures To Be Used for the Intramural Sports Event

Time: 5 min

Method: Interactive Lecture

INTRAMURAL SPORTS EVENT PROCEDURES

The procedure to be used will be dependent upon the sport(s) taking place, the venue it is taking place in, the number of participants, the type of tournament and the type of competition. Information to help assist in determining types of tournaments and how they should be set up can be found in Annex H.

Teaching Point 3

Participate in a Warm Up

Time: 10 min

Method: Participation

PURPOSE OF A WARM UP

A warm up will be composed of light cardiovascular activities designed to:

- stretch the muscles and ligaments;

- gradually increase respiratory action and heart rate;
- expand the muscles' capillaries to accommodate the increase in blood circulation which occurs during physical activity; and
- raise the muscle temperature to facilitate reactions in muscle tissue.

FACTORS TO REMEMBER WHILE STRETCHING

The following factors are important to remember while stretching in order to get ready for physical activity and to help prevent injury:

- Stretch all major muscle groups, including your back, chest, legs and shoulders.
- Never bounce when stretching.
- Hold each stretch for up to 30 seconds to let the muscles release fully.
- Repeat each stretch two to three times.
- When holding a stretch, support your limbs at the joint.
- Static stretching, which is stretching a muscle and holding it in this position without discomfort for 10 to 30 seconds, is considered the safest method of stretching.
- Stretching helps to relax your muscles and improves flexibility, which is the range of movement about your joints.
- As a guide, allow 10 minutes of pre-exercise stretching for every one hour of exercise.



The stretches used should focus on the areas of the body that will be used the most during the given sport(s).

ACTIVITY

Time: 9 min

OBJECTIVE

The purpose of the warm up is to stretch and do light cardiovascular activity to get the body ready for physical activity and to help prevent injury.

RESOURCES

- Gym mats (if available).
- Area large enough for all cadets.

ACTIVITY LAYOUT

- Dependent on numbers, position cadets so that they can see the instructor demonstrate each movement (as per Figure 5-3-1 or 5-3-2). It would be helpful, if possible, to have assistant instructors that can help in demonstrating the movements and ensuring the cadets are performing them properly.
- Cadets should be spread out to have at least two arm lengths between them.

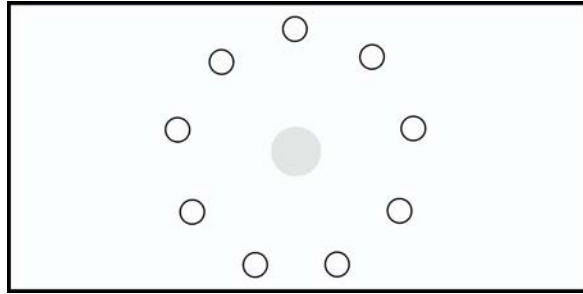

Figure 5-3-1 Instructor in Centre of Warm Up Circle

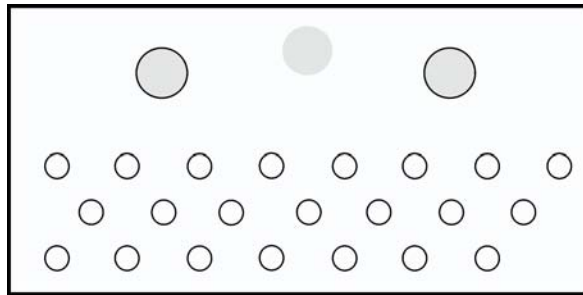

Figure 5-3-2 Instructor at Front With Assistant Instructors

SAFETY

- Ensure there is adequate space between the cadets for them to move freely.
- Ensure the cadets perform the stretches and light cardiovascular activities in a manner that is safe, following the guidelines listed above.

INSTRUCTOR GUIDELINES

- Properly demonstrate each stretch and light cardiovascular activity.
- If assistant instructors are present, brief them as to the manner of the activities and how to ensure the cadets are performing them in a safe manner.
- Have knowledge of what activities are safe and how to prevent injuries from occurring.
- Assess and supervise as each movement is completed to ensure a cadet is not doing them improperly in a manner which may cause injury.



Some sample stretches can be found at Annex C. These are samples only and should not be considered an exhaustive list.

CONFIRMATION OF TEACHING POINT 3

QUESTIONS

Q1. How long should a stretch be held for?

Q2. What is the purpose of performing light cardiovascular activity before participating in physical activity?

ANTICIPATED ANSWERS

A1. Approximately 10 to 30 seconds.

A2. To gradually increase respiratory action and heart rate and to raise the muscle temperature to facilitate reactions in muscle tissue.

Teaching Point 4

Participate in an Organized Intramural Sports Event

Time: 240 min (1 Day)

Method: Participation

PARTICIPATE IN AN ORGANIZED INTRAMURAL SPORTS EVENT

In accordance with the rules and regulations, the cadets shall participate in a given sport from the CCO's list of approved sports, which can be found in Annex A.



The instructor is to ensure safety at all times throughout the conduct of the activity.

ACTIVITY

Time: 240 min

OBJECTIVE

- Demonstrate a basic understanding of the specific sport's rules and regulations.
- Participate actively in organized intramural sports.

RESOURCES

- Sports equipment required for the given sport.
- Safety equipment required for the given sport.
- Whistle.
- Stopwatch.
- First aid equipment.

ACTIVITY LAYOUT

- Prior to the commencement of the organized intramural sport event, set up the sporting venue for the chosen sport(s).
- Break participants into teams evenly (via squadron flight).
- A timekeeper will keep the time.
- A scorekeeper will keep the score.

- A referee will have an auditory device, such as a whistle, to call plays as necessary.
- Upon completion of the game, declare the winner.



Minor changes may have to be made to the set-up of the sport dependent upon the resources and facilities available.

SAFETY

- Ensure cadets are aware of the rules and regulations.
- Ensure assistant instructors are providing supervision at all times during the duration of the activity.
- Ensure a first aid station is set up and all personnel are made aware of where it is.
- Ensure a first aider is identified at the beginning of the activity and is available at all times.

INSTRUCTOR GUIDELINES

- Must be in the sporting venue at all times throughout the conduct of the activity.
- Shall have a whistle, or other sound device, with which to stop play when necessary.
- Should make use of assistant instructors, other senior cadets, or officers, to assist in supervision.

Teaching Point 5

Participate in a Cool Down

Time: 10 min

Method: Participation

PURPOSE OF A COOL DOWN

A cool down will be composed of light cardiovascular activities meant to allow the body time to slowly recover from physical activity and to help prevent injury. Cool downs:

- prepare the respiratory system to return to its normal state; and
- stretch muscles and ligaments to help relax them and restore them to their resting length.

FACTORS TO REMEMBER WHILE STRETCHING

The following factors are important to remember while stretching in order to recover from physical activity and to help prevent injury:

- Stretch all major muscle groups, including your back, chest, legs and shoulders.
- Never bounce when stretching.
- Hold each stretch for up to 30 seconds to let the muscles release fully.
- Repeat each stretch two to three times.
- When holding a stretch, support your limbs at the joint.
- Static stretching, which is stretching a muscle and holding it in this position without discomfort for 10 to 30 seconds, is considered the safest method of stretching.

- Stretching helps to relax your muscles and restore them to their resting length, and improves flexibility, which is the range of movement about your joints.
- As a guide, allow 10 minutes of post-exercise stretching for every one hour of exercise.



The stretches used should focus on the areas of the body that were used the most during the sport(s) activity.

ACTIVITY

Time: 9 min

OBJECTIVE

The purpose of the cool down is to stretch and do light cardiovascular activity to allow the body time to recover from physical activity and to help prevent injury.

RESOURCES

- Gym mats (if available).
- Area large enough for all cadets.

ACTIVITY LAYOUT

- Dependent on numbers, position cadets so that they can see the instructor as they demonstrate each movement (as per Figure 5-3-3 or 5-3-4). It would be helpful, if possible, to have assistant instructors that can help in demonstrating the movements and ensuring the cadets are performing them properly.
- Cadets should be spread out to have at least two arm lengths between them.

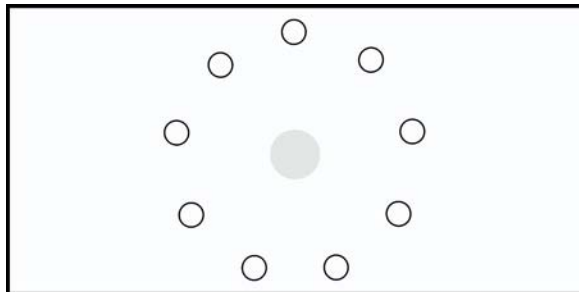

Figure 5-3-3 Instructor in Centre of Cool Down Circle

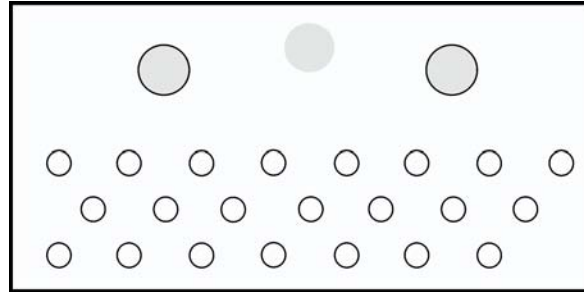

Figure 5-3-4 Instructor at Front With Assistant Instructors

SAFETY

- Ensure there is adequate space between cadets for them to move freely.
- Ensure the cadets perform the stretches and light cardiovascular activities in a manner that is safe, following the guidelines listed above.

INSTRUCTOR GUIDELINES

- Demonstrate each stretch and light cardiovascular activity.
- If assistant instructors are present, brief them as to the manner of the activities and how to ensure the cadets are performing them in a safe manner.
- Have knowledge of what activities are safe and how to prevent injuries from occurring.
- Assess and supervise as each movement is completed to ensure a cadet is not doing them improperly in a manner which may cause injury.



Some sample stretches can be found at Annex C. These are samples only and should not be considered an exhaustive list.

CONFIRMATION OF TEACHING POINT 5

QUESTIONS

Q1. What is the purpose of performing a cool down?

ANTICIPATED ANSWERS

A1. To prepare the respiratory and cardiovascular systems to return to their normal state and to stretch the muscles and ligaments to help relax them and restore them to their resting length.

END OF LESSON CONFIRMATION

Cadets will be supervised throughout the duration of the intramural sport(s) event. The focus shall be on the cadets' participation.

CONCLUSION

HOMework/READING/PRACTICE

N/A.

METHOD OF EVALUATION

There is no formal assessment for this EO. Cadets will be supervised throughout the duration of the intramural sports event.

CLOSING STATEMENT

Every cadet in year one training may be given the opportunity to participate in organized intramural sports. There should be no focus on competition at this level; rather, the cadets should be focused on participating and demonstrating sportsmanship as a member of a team.

INSTRUCTOR NOTES/REMARKS

The organized intramural sports can be broken down in two ways. The overall objective is for cadets to participate in nine periods of intramural sports. This can be carried out over three training sessions, or it can be done as a training day.

REFERENCES

- Cadets Canada. (2007). Canadian Cadet Movement List of Approved Sports (Annexes A and B).
- C0-001 (ISBN 0-88011-807-5) Hanlon, T. (1998). *The Sports Rules Book: Essential Rules for 54 Sports*. USA: Human Kinetics Publishers.
- C0-002 (ISBN 0-88962-630-8) LeBlanc, J., and Dickson, L. (1997). *Straight Talk About Children and Sport: Advice for Parents, Coaches, and Teachers*. Oakville, ON and Buffalo, NY: Mosaic Press.
- C0-030 Ringette Canada. Retrieved 27 April 2006, from www.ringette.ca.
- C0-031 Ultimate. Retrieved 27 April 2006, from www.whatisultimate.com.
- C0-032 Stanford Intramurals, Department of Athletics, Physical Education and Recreation. Retrieved 30 April 2006, from www.stanford.edu/group/Intramurals/kickballrules.html.
- C0-033 Slam Sports (2006). Retrieved 30 April 2006, from www.slam.canoe.ca/FlagFootball/Rules/home.html.
- C0-034 Ultimate Players Association (2000-2005). Retrieved 27 April 2006, from www.upa.org/ultimate.
- C0-035 World Adult Kickball Association (1998-2006). Retrieved 1 May 2006, from www.kickball.com.
- C0-036 Women's Heart Foundation (1999-2000). Retrieved 25 April 2006, from www.womensheart.org/content/Exercise/stretching_exercise.asp.
- C0-037 Walkablock Club of America (2005). Retrieved 25 April 2006, from www.walkablock.com/stretch2.gif.
- C0-038 Shelter Online (2006). Retrieved 25 April 2006, from www.shelterpub.com/_fitness/online_stretches.gif.
- C0-039 Retrieved 25 April 2006, from www.eeshop.unl.edu.

- C0-040 Lose the Back Pain (2006). Retrieved 25 April 2006, from www.losethebackpain.com.
- C0-041 Roadcycling (2006). Retrieved 25 April 2006, from www.roadcycling.com/artman/upload/stretch.jpg.
- C0-042 Spine Universe. Retrieved 25 April 2006, from www.spineuniverse.com.



COMMON TRAINING INSTRUCTIONAL GUIDE



SECTION 4

EO C105.03 – PARTICIPATE IN AN ORIENTEERING EVENT

Total Time:

3 Sessions or 1 Day

INTRODUCTION

PRE-LESSON INSTRUCTIONS

A complete list of resources needed for the instruction of this EO is located at Chapter 2 of the QSP. Specific uses for said stores are identified throughout the Instructional Guide, within the teaching point for which they are required.

Prior to instructing this lesson the instructor shall:

- review the lesson content, and become familiar with the material;
- gather all equipment discussed in the lesson;
- put a sample score card on each cadet's desk for TP1;
- photocopy samples of real orienteering score cards, so the cadets may keep them after the lesson;
- arrange for assistants to help with TP5 to TP7; and
- set up an orienteering course.

PRE-LESSON ASSIGNMENT

Cadets are to bring appropriate sports attire.

APPROACH

The interactive lecture method was chosen for TP1 and TP4 as it allows the instructor to make a semi-formal presentation of the material where the cadets can participate by asking or responding to questions and commenting on the material. For this lesson, this method is most effective as it matches well the taxonomic level of the material and is age-appropriate by virtue of its participatory nature.

The demonstration and performance methods were chosen for TP2 due to the practical nature of the subject matter. These methods provide the instructor the opportunity to introduce the subject matter, demonstrate procedures and observe the cadets practicing and performing the skill. The demonstration and performance methods must always be used when the taxonomic level of the material requires a performance of a skill. These methods are highly developmentally appropriate for young cadets.

The participation method was chosen for TP5 to TP7 as it allows the cadets to engage freely in the activity. The cadets should be encouraged to interact with all other group members. The instructor must foster an environment that involves the contributions of all cadets, regardless of their skill level. This methodology requires adequate supervision by senior cadets and adult staff.

REVIEW

N/A.

OBJECTIVES

By the end of this lesson the cadet shall be expected to have participated in an orienteering event.

IMPORTANCE

It is important for today's youth to be active and to learn how to act as a member of a team. By participating as an individual or as a member of an orienteering team, the cadets are given the opportunity to be active in a sport that will contribute to their living a healthy, physically active lifestyle.

Teaching Point 1

Identify Orienteering Equipment



Time: 15 min

Method: Interactive Lecture

MARGINAL INFORMATION ON MAPS

The marginal information found on a map includes:

- **Scale.** Map scale is found at the bottom of the map title. The most common scales for topographical maps in Canada are 1:25 000 and 1:50 000. Common orienteering map scales are 1:5000, 1:10 000, 1:15 000 and 1:20 000. This means that one unit on the map represents 5000 units on real terrain. The smaller the map scale, the smaller the area is, and the more detail there is available to the competitor.
- **International Orienteering Federation (IOF) Colours.** The IOF has standardized colours:
 - Brown: Land forms/elevation features.
 - Black: Man made features.
 - Blue: Water and marsh.
 - Yellow: Open and semi-open areas with good visibility.
 - White: Forest providing good running for that type of forest.
 - Green: Vegetation.
 - Violet: Course overprinting and out-of-bounds areas.
- **IOF Symbols.** These symbols are simplified representations of map features that are universal to all orienteering competitors in all countries in the world. These are hints that appear on a description sheet. These symbols have been divided into five groups as follows:
 - landforms;
 - rock features;
 - man-made features;
 - water features; and
 - vegetation.

	Cave	A hole in a rock face or hillside, often leading to underground workings.
	Boulder	A prominent free-standing block of rock or stone.
	Boulder Field	An area covered by so many boulders that they cannot be individually mapped.

International Specifications for Control Descriptions

Figure 5-4-1 Example of IOF Symbols

- **Contour Lines.** A contour line is an imaginary line on the ground along which all points are at the same height above sea level (Orienteering: Level 1 Coaching). Contour lines help illustrate shapes and forms on the ground and give a picture of the terrain to the map user. When contour lines are close together, the slope is steeper. When they are spaced apart, the slope is gentle.
- **Contour Intervals.** The contour interval is the vertical distance in the terrain between points situated on two adjacent contour lines (Orienteering: Level 1 Coaching). This interval is usually in feet on a topographical map and in metres on an orienteering map.



IOF symbols and information found on a description card are located on the IOF's Website at <http://www.orienteering.org/footo/pictsymb.htm>.

PARTS OF THE ORIENTEERING COMPASS

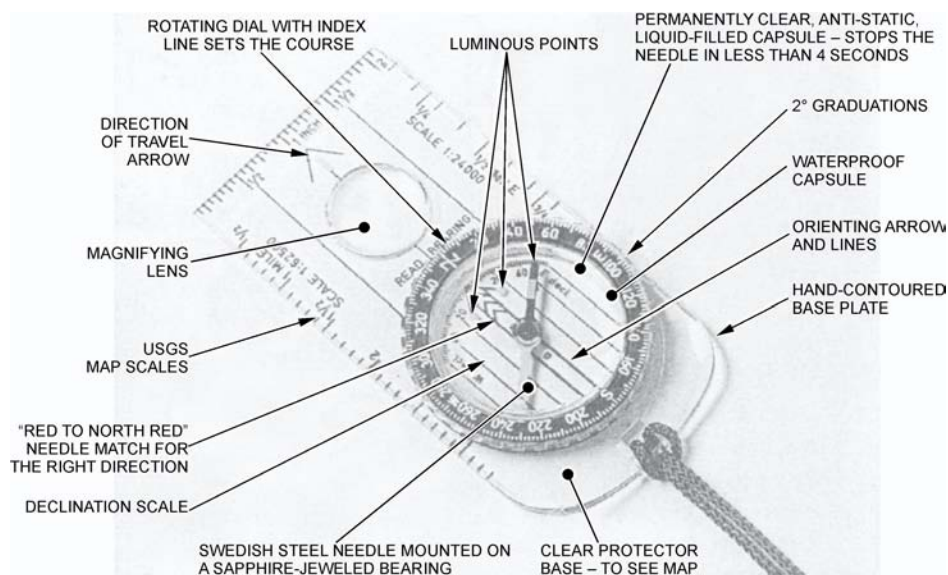

Be Expert With Map & Compass: The Complete Orienteering Handbook

Figure 5-4-2 Orienteering Compass

- **Magnetic Needle.** Suspended on a sharp point so it can swing freely. The north end of it is red, and on some models, it is also marked with a luminous band.

- **Compass Housing.** Marked with the initials of the four cardinal points, it is also divided into degree lines. Each space between the lines is 2°. The bottom is transparent and has an orienting arrow which points to 360° north. The housing can be rotated manually on the standard base plate model, but is fixed on the thumb compass.
- **Base Plate.** Rectangular and transparent, which can be turned easily. It runs from the edge of the compass housing to the front edge of the plate where it spreads into an arrow, called the direction of travel arrow. The raised part of the base plate has a black index pointer on a white background to show at what degree number the compass housing is set. The side edge of the base plate has markings for measuring and is the measuring scale. Some are in millimetres and some are in more common map scales.

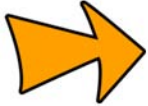

The diagram refers to “red to north red” needle match for determining the right direction. You may also hear it referred to as “red in the bed”, and may offer it to the cadets as a way to check that their compass is oriented.

SCORING EQUIPMENT

Scoring equipment includes:

- **Control Markers.** Found at control points on an orienteering course, they consist of three squares joined together into a hollow triangular shape. Control markers are divided diagonally bottom left to top right into two triangles. The top left hand triangle is white and the bottom right hand triangle is an orange-red colour.

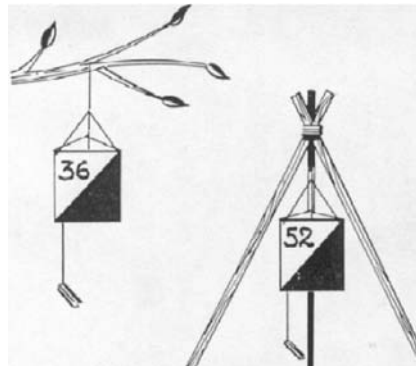

Be Expert With Map & Compass: The Complete Orienteering Handbook

Figure 5-4-3 Control Markers

- **Control Punches (Clippers).** Attached to the control markers, the punch will often hang from the control marker. Each one on an orienteering course is different and therefore aids an orienteering competition in having the competitors collect them in a specified order. Each punch has a different series of numbers or letters.
- **Description Sheets.** The control description sheet contains all the information on the competitor and their race, as well as IOF symbols or written descriptions of the control points.
- **Score Cards.** Also known as the control card, it is what the competitor uses to collect the stamps of the control markers on the course. It is handed in at the end of the race.

Orienteering® Control Point Card		CLASS MI	COURSE W	No. 16	FINISH 1:46:45					START 18:00						
COLOUR		NAME JOHN DOE			CLUB NONESUCH					compass						
SILVA®		day	time ck	punch ck	place	TIME 1:28:45					DETACH					
ALL COMPETITORS MUST REPORT TO THE FINISH												FOLD				
11	12	13	14	15	16	17	18	19	20	PLACE	TIME	DAY	COURSE	COLOUR		
1	2	3	4	5	6	7	8	9	10	DAY	1:28:45		MI	W		
										CLASS	NAME	CLUB				
											JOHN DOE	NONESUCH				

Be Expert With Map & Compass: The Complete Orienteering Handbook

Figure 5-4-4 Silva Score Card



Orienteering control markers can be improvised by using cardboard or plastic gallon jugs.

CONFIRMATION OF TEACHING POINT 1

QUESTIONS

- Q1. What colour represents water and marsh?
- Q2. If contour lines are close together, what slope would you expect to come across?
- Q3. What is one of the three main parts on an orienteering compass?
- Q4. What are some types of scoring equipment?
- Q5. What is found on the description card?

ANTICIPATED ANSWERS

- A1. Blue represents water and marsh.
- A2. The slope is steep.
- A3. The magnetic needle, compass housing or base plate.
- A4. Any of the following: description card, score sheet, control markers.
- A5. The description card offers the competitor a description of what can be found at the control point.

Teaching Point 2

Explain and Demonstrate Orienteering Techniques

Time: 15 min

Method: Demonstration and Performance

ORIENTEERING TECHNIQUES

Orienteering techniques include:

- **Folding and Holding the Map.** Folding the map involves the orienteer gently folding the map once so that the route is showing, running along the direction of travel, with everything else folded out of the way.

It helps the orienteer see only the information pertaining to them at the time. Holding the map depends on what kind of compass the orienteer is using and the hand the compass will be carried in.

- **Orienting the Map.** A map is oriented when north on the map is aligned with north on the terrain. The map user should pick out two to three objects in front of them, and then locate them on the map. The real landmarks and the ones on the map should line up. This is called orienting the map by inspection. To orient a map with a compass, the easiest way is to place the edge of the base plate parallel with the magnetic-north line, then turn the map until the compass on it is oriented.

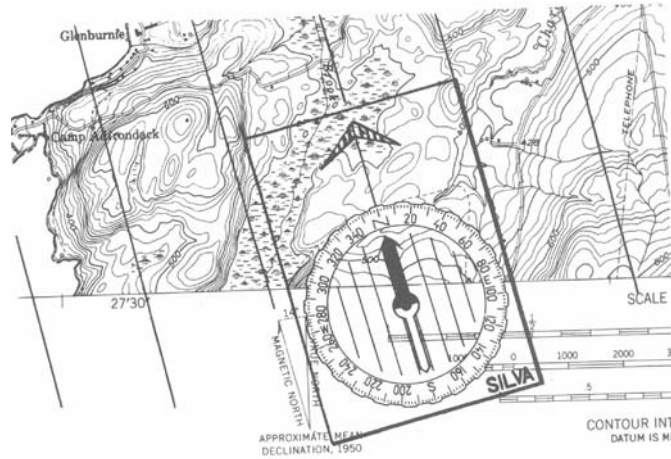

Be Expert With Map & Compass: The Complete Orienteering Handbook

Figure 5-4-5 Orienting a Compass to Map

- **Thumbing Position on the Map.** The orienteer should be holding the map properly and then place their thumb on the map to mark their position at all times. It saves time, helping to quickly determine where the orienteer is, no matter how many times they have to stop and look at their map. Two main steps involved in this process are ensuring the map is held properly and holding the map so it is oriented to the north.

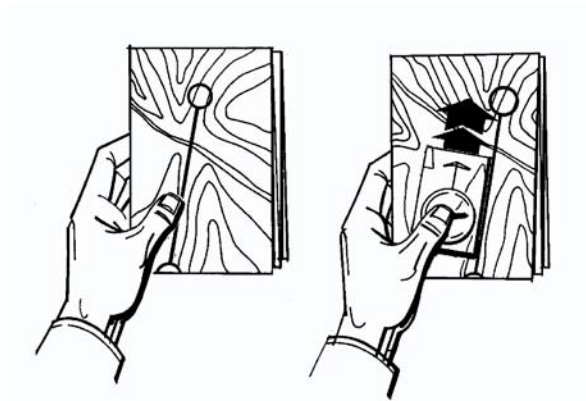

Be Expert With Map & Compass: The Complete Orienteering Handbook

Figure 5-4-6 Thumbing Position

- **Determining Distance.** Orienteers should not rely on features for judging distance. They may no longer exist though they still appear on the map. The best way is “step counting” or pacing. This is determined by knowing how many steps or paces an individual takes in 100 metres. To save time, an orienteer should know this before beginning a race.

- **Checking Off Features.** Linear features that appear before the control alert the orienteer that the control is nearby. As an orienteer navigates toward the control, they have a mental checklist of the features as they come upon them.



The instructor should walk the cadets through using these techniques outside explaining them as they go.

CONFIRMATION OF TEACHING POINT 2

QUESTIONS

- Q1. What is the purpose of keeping your thumb on your map?
- Q2. What is the best way of judging distance for an orienteer?
- Q3. What is checking off features?

ANTICIPATED ANSWERS

- A1. To keep track of location.
- A2. Counting steps or pacing.
- A3. Checking off features is a technique where the orienteer makes a mental checklist of the features leading to their control, helping them determine how close they are to the control.

Teaching Point 3

Explain Techniques for Route Evaluation

Time: 10 min

Method: Demonstration and Performance

TECHNIQUES FOR ROUTE EVALUATION

Techniques for route evaluation include:

- **Handrails.** A prominent linear feature that runs more or less parallel to the direction you are supposed to go and takes you to your control. A path between two points would be a handrail.
- **Catching Features.** Sometimes called collecting features. A technique for route evaluation that helps the orienteer make a mental checklist of all the features they must collect or catch before they can get to their control. It is a large distinct feature situated across the line of travel on the route to, or beyond, the control. It must be a feature that is easy to recognize in the terrain, such as a large pond or power line. If it is situated in front of the control it acts as an alert to the control. When situated beyond the control it alerts the orienteer that they have travelled past the point of the control.
- **Attack Points.** Some points are located on small features which are not easily found. For this, the orienteer might locate a larger feature as close to the control as possible. The orienteer will look for this feature, called the “attack point”, run towards this point, and then look for the control close by.
- **Attacking From Above.** A control located on the side of a slope is easier for the orienteer to find when they are coming down the slope. The orienteer gets a better view of the terrain by looking down on it, and is therefore able to find the best route to the control.

- **Height Assessment Versus Detouring Around.** When a hill is in the way of running from one control to the next, a decision must be made by the orienteer whether to go over or around. It must be decided if it is easier for the individual to climb up the slope and possibly expend more energy, or to go around, which may be a longer route but easier to run due to level ground. The elevation of the slope may be a deciding factor.
- **Long Easy Route Versus Short Tough Route.** Another decision that must be made by the competitor is the progress that can be made dependent on the vegetation that will be encountered. They must take into consideration the distance to travel both routes, and how quickly they will be able to travel over the type of terrain.



The instructor should walk the cadets through the use of these techniques outside explaining them as they go.



This may seem overwhelming for the novice orienteer, but cadets should know that they would naturally use some of these techniques without realizing it.

CONFIRMATION OF TEACHING POINT 3

QUESTIONS

- Q1. Why does the orienteer need attack points?
- Q2. What are catching or collecting features?

ANTICIPATED ANSWERS

- A1. The orienteer needs attack points, because controls are often placed on small features that are difficult to find.
- A2. An orienteer may make a mental checklist of features before their control and collect them so they can tell how far away they are from the control.

Teaching Point 4

Identify Map Reading Techniques

Time: 10 min

Method: Interactive Lecture

MAP READING TECHNIQUES

Map reading techniques include:

- **“CART” Technique.** A systematic approach to map reading, represented by an acronym meaning:
 - **Control.** What control is the orienteer trying to find?
 - **Attack Point.** What is an attack point that is easy to identify? It should be close to and before the marker, should be distinct, prominent and easy to reach.
 - **Route Choice.** What is the best route to the attack point? This will depend on the nature of the terrain, the distance to be covered, and the skills and abilities of the orienteer.

- **Technique.** What is the best technique to use on each leg of the competition? This will once again depend on the terrain, distance, and the individual orienteer, but must be decided before starting the leg.
- **Map Simplification.** Is a process where only the large and relevant features are noted while irrelevant and/or minor details are ignored. Modern maps are very detailed and can be confusing to an orienteer who might read all detail. This method of simplifying the map makes it easier for the orienteer to proceed quickly through detailed terrain and to go from one control to the next attack point by reading only the large and more pertinent details.
- **Rough Map Reading.** In this manner an orienteer navigates through the course by reading the large, easily recognizable features while excluding small details. It allows for faster running while reading the large features and noting only approximate positions from the map. This technique is used to navigate from one control, or the start point, to the attack point for the next control in terrain with distinct features. An important rule to remember is to never run further than where you know you approximately are on the map.
- **Precision Map Reading.** In this manner an orienteer reads the small accurate details in the terrain, allowing them to know their exact position at all times. This technique is used primarily when navigating from the attack point to the control, in an area which is full of map detail. When precision map reading, it is important to run at a speed that permits you to know exactly where you are on the map.
- **Pace Counting.** Many orienteers will use it along a handrail to find an attack point and then from an attack point to a control located on a point feature. To count your paces, count every second pace, or how many times your left foot hits the ground, over a 100-metre distance. An orienteer should always know their paces before starting a meet.
- **Distance Estimation.** For distance estimation, the orienteer would notice that two distances on the map are almost identical and would count their paces over the first distance, and thus determine how many paces would be necessary to cover the second distance based on their first number.

CONFIRMATION OF TEACHING POINT 4

QUESTIONS

- Q1. What is the “CART” technique?
- Q2. What is map simplification?

ANTICIPATED ANSWERS

- A1. A systematic approach to map reading that encompasses control, attack point, route choice, and technique.
- A2. Map simplification is a process of noting only the large, important features and ignoring the smaller features in order to make it easier to get to the next control.

Teaching Point 5

Participate in a Warm Up

Time: 10 min

Method: Participation

PURPOSE OF A PROPER WARM UP

A warm up will be composed of light cardiovascular activities designed to:

- stretch the muscles and ligaments;

- gradually increase respiratory action and heart rate;
- expand the muscles' capillaries to accommodate the increase in blood circulation which occurs during physical activity; and
- raise the muscle temperature to facilitate reactions in muscle tissue.

FACTORS TO REMEMBER WHILE STRETCHING

The following factors are important to remember while stretching in order to get ready for physical activity and to help prevent injury:

- Stretch all major muscle groups, including your back, chest, legs and shoulders.
- Never bounce when stretching.
- Hold each stretch for up to 30 seconds to let the muscles release fully.
- Repeat each stretch two to three times.
- When holding a stretch, support your limbs at the joint.
- Static stretching, which is stretching a muscle and holding it in this position without discomfort for 10 to 30 seconds, is considered the safest method of stretching.
- Stretching helps to relax your muscles and improves flexibility, which is the range of movement about your joints.
- As a guide, allow 10 minutes of pre-exercise stretching for every one hour of exercise



The stretches used should focus on the areas of the body that will be used the most during the orienteering event.

ACTIVITY

Time: 9 min

OBJECTIVE

The purpose of the warm up is to stretch and do light cardiovascular activity to get the body ready for physical activity and to help prevent injury.

RESOURCES

- Gym mats (if available).
- Area large enough for all cadets.

ACTIVITY LAYOUT

- Dependent on numbers, position cadets so that they can see the instructor demonstrate each movement (as per Figure 5-4-7 or 5-4-8). It would be helpful, if possible, to have assistant instructors that can help in demonstrating the movements and ensuring the cadets are performing them properly.
- Cadets should be spread out to have at least two arm lengths between them.

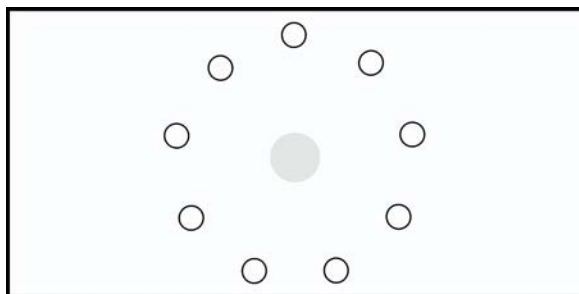

Figure 5-4-7 Instructor in Centre of Warm Up Circle

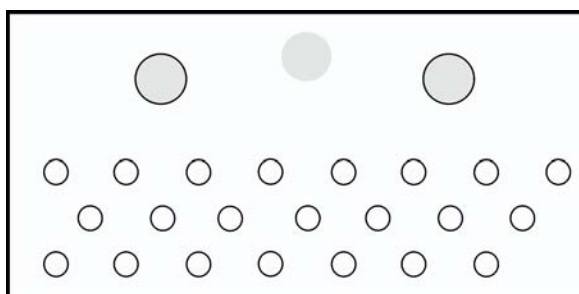

Figure 5-4-8 Instructor at Front With Assistant Instructors

SAFETY

- Ensure there is adequate space between the cadets for them to move freely.
- Ensure the cadets perform the stretches and light cardiovascular activities in a manner that is safe, following the guidelines listed above.

INSTRUCTOR GUIDELINES

- Demonstrate each stretch and light cardiovascular activity.
- If assistant instructors are present, brief them as to the manner of the activities and how to ensure the cadets are performing them in a safe manner.
- Have knowledge of what activities are safe and how to prevent injuries from occurring.
- Assess and supervise as each movement is completed to ensure a cadet is not doing them improperly in a manner which may cause injury.



Some sample stretches can be found at Annex C. These are samples only and should not be considered an exhaustive list.

CONFIRMATION OF TEACHING POINT 5

QUESTIONS

- Q1. How long should a stretch be held for?

Q2. What is the purpose of performing light cardiovascular activity before participating in physical activity?

ANTICIPATED ANSWERS

A1. Approximately 10 to 30 seconds.

A2. To gradually increase respiratory action and heart rate and to raise the muscle temperature to facilitate reactions in muscle tissue.

Teaching Point 6

Participate in an Orienteering Event

Time: 190 min

Method: Participation

STARTING

At this point, the cadets will move to the starting line to be sent off by a blast from the instructor's whistle. At this point a departure time must be written down on the recorder's sheet, as per the example in Figure 5-4-10.

Usually at the beginning of the event there will be an area called the starting grid. This gives the participants a three-minute preparation period prior to starting the event.

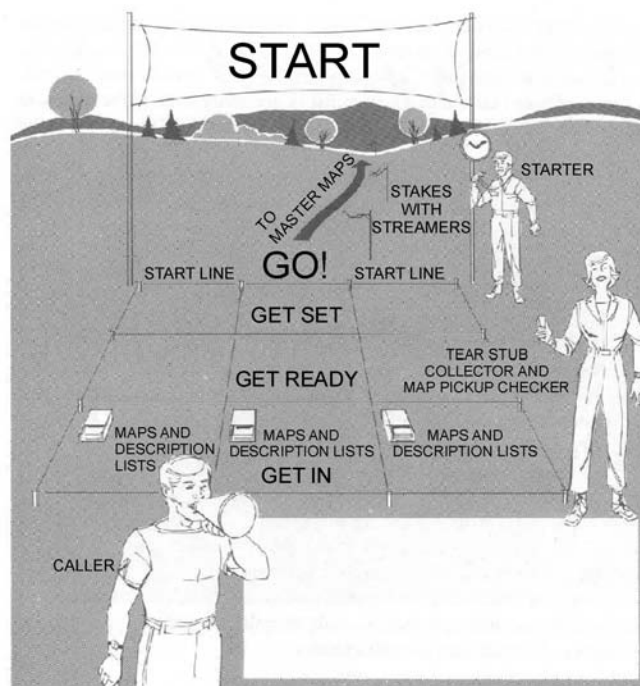

Be Expert With Map & Compass: The Complete Orienteering Handbook

Figure 5-4-9 Sample Start Grid

Three minutes before the cadet is to start, they are called to the "Get In" row of the starting grid. A minute later, upon hearing a whistle, the cadets move forward to the "Get Ready" row, where they review a copy of the description list and the map (if it is not a pre-marked map). One minute before the start, the cadets move to the "Get Set" row, where pre-marked maps would be distributed, but are not allowed to be looked at until they hear the "Go" whistle.

On the zero-minute, there will be a "Go" whistle, signalling cadets to begin. It is at this point that the departure time is recorded on the recorder's sheet.

- Stopwatches.
- Orienteering maps.
- Orienteering compasses.
- Control markers with punches.
- Pencils.
- Description sheets.
- Rope.
- Radios, when available.
- First aid equipment.

ACTIVITY LAYOUT

- Prior to the commencement of the orienteering event:
 - set up the orienteering course;
 - fill out description sheets;
 - make pre-marked orienteering maps; and
 - arrange for assistants.
- Break cadets into groups of two.
- Choose a timekeeper who will keep the time and record it on the master recording sheet.
- Have the cadets begin the event one group at a time, by starting in the first part of the starting grid, and progressing through it in sequence.
- Have each subsequent group of cadets follow through in the same manner, at specifically timed intervals.
- As each group arrives back at the finish line, have the timekeeper call out the time and write it down on the master recording sheet.
- The winning team is the team who finishes in the fastest time with the least amount of deductions.

SAFETY

Ensure senior cadets/officers are stationed at intervals along the course to assist cadets who may get disoriented or who may get hurt.

INSTRUCTOR GUIDELINES

- Ensure safety at all times throughout the event.
- Have a whistle to signal times in the starting grid.
- Use assistants to keep the time, record information on the recording sheet, and position themselves at periodic intervals throughout the course.

Teaching Point 7**Participate in a Cool Down**

Time: 10 min

Method: Participation

PURPOSE OF A COOL DOWN

A cool down will be composed of light cardiovascular activities meant to allow the body time to slowly recover from physical activity and to help prevent injury. Cool downs:

- prepare the respiratory system to return to its normal state; and
- stretch muscles and ligaments to help relax them and restore them to their resting length.

FACTORS TO REMEMBER WHILE STRETCHING

The following factors are important to remember while stretching in order to recover from physical activity and to help prevent injury:

- Stretch all major muscle groups, including your back, chest, legs and shoulders.
- Never bounce when stretching.
- Hold each stretch for up to 30 seconds to let the muscles release fully.
- Repeat each stretch two to three times.
- When holding a stretch, support your limbs at the joint.
- Static stretching, which is stretching a muscle and holding it in this position without discomfort for 10 to 30 seconds, is considered the safest method of stretching.
- Stretching helps to relax your muscles and restore them to their resting length, and improves flexibility, which is the range of movement about your joints.
- As a guide, allow 10 minutes of post-exercise stretching for every one hour of exercise.



The stretches used should focus on the areas of the body that were used the most during the orienteering event.

ACTIVITYTime: 9 min

OBJECTIVE

The purpose of the cool down is to stretch and do light cardiovascular activity to allow the body time to recover from physical activity and to help prevent injury.

RESOURCES

- Gym mats (if available).
- Area large enough for all cadets.

ACTIVITY LAYOUT

- Dependent on numbers, position cadets so that they can see the instructor as they demonstrate each movement (as per Figure 5-4-11 or 5-4-12). It would be helpful, if possible, to have assistant instructors that can help in demonstrating the movements and ensuring the cadets are performing them properly.
- Cadets should be spread out to have at least two arm lengths between them.

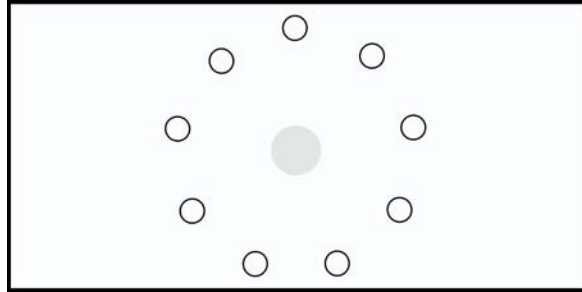

Figure 5-4-11 Instructor in Centre of Cool Down Circle

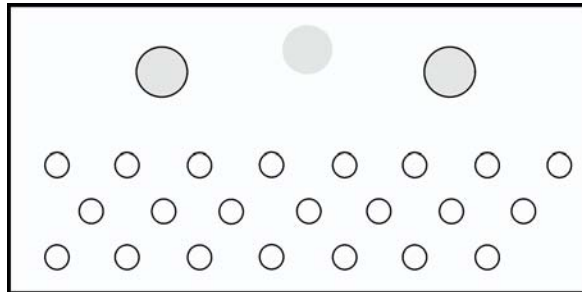

Figure 5-4-12 Instructor at Front With Assistant Instructors

SAFETY

- Ensure there is adequate space between cadets for them to move freely.
- Ensure the cadets perform the stretches and light cardiovascular activities in a manner that is safe, following the guidelines listed above.

INSTRUCTOR GUIDELINES

- Demonstrate each stretch and light cardiovascular activity.
- If assistant instructors are present, brief them as to the manner of the activities and how to ensure the cadets are performing them in a safe manner.
- Have knowledge of what activities are safe and how to prevent injuries from occurring.
- Assess and supervise as each movement is completed to ensure a cadet is not doing them improperly in a manner which may cause injury.

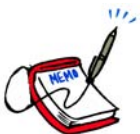

Some sample stretches can be found at Annex C. These are samples only and should not be considered an exhaustive list.

CONFIRMATION OF TEACHING POINT 7

QUESTIONS

Q1. What is the purpose of performing a cool down?

ANTICIPATED ANSWERS

A1. To prepare the respiratory and cardiovascular systems to return to their normal state and to stretch the muscles and ligaments to help relax them and restore them to their resting length.

END OF LESSON CONFIRMATION

Cadets will participate in an orienteering event as part of this lesson.

CONCLUSION

HOMEWORK/READING/PRACTICE

N/A.

METHOD OF EVALUATION

There is no formal assessment of this EO. Instructors will supervise the cadets while they participate in an orienteering event.

CLOSING STATEMENT

Every cadet in year one training should be given the opportunity to participate in an organized orienteering event. There should be no focus on competition at this level; rather, the cadets should be focused on participating and demonstrating sportsmanship.

INSTRUCTOR NOTES/REMARKS

Orienteering can be broken down in two ways. The overall objective is for cadets to participate in nine periods of orienteering. This can be carried out over three training sessions, where the first night would encompass TP1 to TP4, and the two subsequent nights would encompass TP5 to TP7. It can also be done in one training day.

REFERENCES

- C0-002 (ISBN 0-88962-630-8) LeBlanc, J., and Dickson, L. (1997). *Straight Talk About Children and Sport: Advice for Parents, Coaches, and Teachers*. Oakville, ON and Buffalo, NY: Mosaic Press.
- C0-007 (ISBN 0-02-029265-1) Kjellstrom, B. (1994). *Be Expert With Map & Compass: The Complete Orienteering Handbook*. New York: Hungry Minds, Inc.
- C0-008 (A-CR-CCP-151/PT-001) Canadian Orienteering Federation (1983). *Orienteering Level 1 Coaching Certification*. National Coaching Certification Program, Canadian Orienteering Federation.
- C0-009 International Orienteering Federation (2006). Retrieved 20 April 2006, from <http://www.orienteering.org/footo/pictsymb.htm>.

- C0-010 Stott, W. (1987). *Armchair Orienteering II: A Practical Guide to Route Planning*. Winnipeg: Manitoba Orienteering Association.
- C0-011 Canadian Orienteering Federation (1985). *Orienteering Level Two Coaching Certification*.
- C0-023 (A-CR-CCP-150/PT-001) Chapman, J.R. Major, M.B.E. (1968). *Orienteering: an Aid to Training*. London, England: Hillside Printing & Publishing Co.
- C0-036 Women's Heart Foundation (1999-2000). Retrieved 25 April 2006, from www.womensheart.org/content/Exercise/stretching_exercise.asp.
- C0-037 Walkablock Club of America (2005). Retrieved 25 April 2006, from www.walkablock.com/stretch2.gif.
- C0-038 Shelter Online (2006). Retrieved 25 April 2006, from www.shelterpub.com/_fitness/online_stretches.gif.
- C0-039 Retrieved 25 April 2006, from www.eeshop.unl.edu.
- C0-040 Lose the Back Pain (2006). Retrieved 25 April 2006, from www.losethebackpain.com.
- C0-041 Roadcycling (2006). Retrieved 25 April 2006, from www.roadcycling.com/artman/upload/stretches.jpg.
- C0-042 Spine Universe. Retrieved 25 April 2006, from www.spineuniverse.com.

CANADIAN CADET ORGANIZATION LIST OF APPROVED SPORTS

- Baseball.
- Basketball.
- Floor Hockey.
- Lacrosse.
- Orienteering.
- Ringette.
- Soccer.
- Soccer Baseball.
- Softball.
- Touch Football.
- Ultimate Frisbee.
- Volleyball.

THIS PAGE INTENTIONALLY LEFT BLANK

RECREATIONAL SPORTS OVERVIEW

The list of activities provided for recreational sports is not an exhaustive list. There are other sports that may be approved if a corps or squadron wishes to request approval from their regional chain of command.

The basic rules that are provided for the approved sports are the rules for professional or competitive sports, which have been adapted in some instances. The rules and diagrams may be altered according to the resources and facilities that are available to the squadron. For example, in ultimate frisbee, the game can be altered for play in an indoor gymnasium instead of outdoors on a field.

In many instances, the number of players per team can be adapted according to the number of cadets who are playing the sport. For example, for touch/flag football the number of players is listed for five, but teams can play with more than five players on the field at a given time. Times and breakdowns of timings can be altered as well in order to fit into timeframes.

Any sport that usually involves some form of contact between competitors shall be adapted to ensure there is no contact when played by cadets.

A basic overview of orienteering is not found in this section as it can be found in EO C105.03 (Section 4).

BASEBALL

Objective: While trying to prevent the opposing team from scoring runs, each team tries to score as many runs as possible. A run is scored when a team's player runs (in a counterclockwise direction) and steps on all three bases and the home plate, which is also known as completing the circuit. A game lasts nine innings where the team with the highest score wins, unless there is a tie. In that case the game will continue for additional innings until a team scoring an additional run breaks the tie (www.angelfire.lycos.com).

Scoring: One point is awarded as a member completes a circuit around the bases.

Definitions:

Ball	A ball is when the pitch is not within the strike zone.
Bunt	When a batter hits the ball by letting the ball meet the bat to drop as a soft ground ball on the infield.
Double Play	When two outs are made on the same play.
Fly Ball	A ball batted high into the air.
Fly-out	Is a fly ball that is caught before it touches the ground or the fence.
Force Play	This occurs when a runner is forced to move to the next base because the batter becomes a runner.
Foul Ball	A ball that is hit into foul territory (see Figure 5B-1).
Foul Territory	The area outside the foul lines.
Home Run	When a batter hits a fair ball over the fence, or circles the bases on a hit inside the fence without getting out on their way around.
Inning	An inning consists of a top and a bottom. During either the top or bottom half each team will get the opportunity to bat and field accordingly.
Out	An out can be given due to strikeout (three strikes), force-out, tag-out, and fly-out.
Strike	A pitch that the batter takes but does not swing at which is in the strike zone, that the batter swings at and misses, or that the batter hits into foul territory during their first two strikes. A foul ball on the third is not considered a strike.
Walk	A batter is awarded first base if a pitcher pitches four "balls" during one time up to bat.

Number of Players: Nine players per team.

BASEBALL	
Equipment Required:	
<ul style="list-style-type: none"> • Bases x 4. • Bat x 2. • Batter's helmets x 2. 	<ul style="list-style-type: none"> • Baseball x 1 (extras should be on hand). • Various gloves. • Baseball/Softball field.
Basic Rules:	
<ul style="list-style-type: none"> • The game consists of nine innings, with three outs per inning (for each team). May be limited due to time constraints. • One team takes the field first, taking up the various positions, to include: pitcher, catcher, first baseman, second baseman, third baseman, shortstop, left fielder, centre fielder, and right fielder (see Figure 5B-1). • The other team bats first in the top half of the inning, according to the batting order for their players. • The pitcher attempts to get the batter out, preventing him or her from reaching first base and the subsequent bases. • A batter is out if they receive three strikes or if they hit the ball but it is caught by someone in the field before it hits the ground. • The batters objective is to get around the bases before the ball reaches the base. The batter has to attempt to get to first base before the ball reaches the base and to possibly continue going until they feel they can get no further. Once their play is over the next batter is up. • A team scores a run when a player has safely touched first, second, and third base and has made it back home, or hits the ball over the fence. 	
<p>Further details on the sport of baseball can be found in <i>The Sports Rules Book: Essential Rules for 54 Sports</i> (1998), pp. 25-35.</p>	

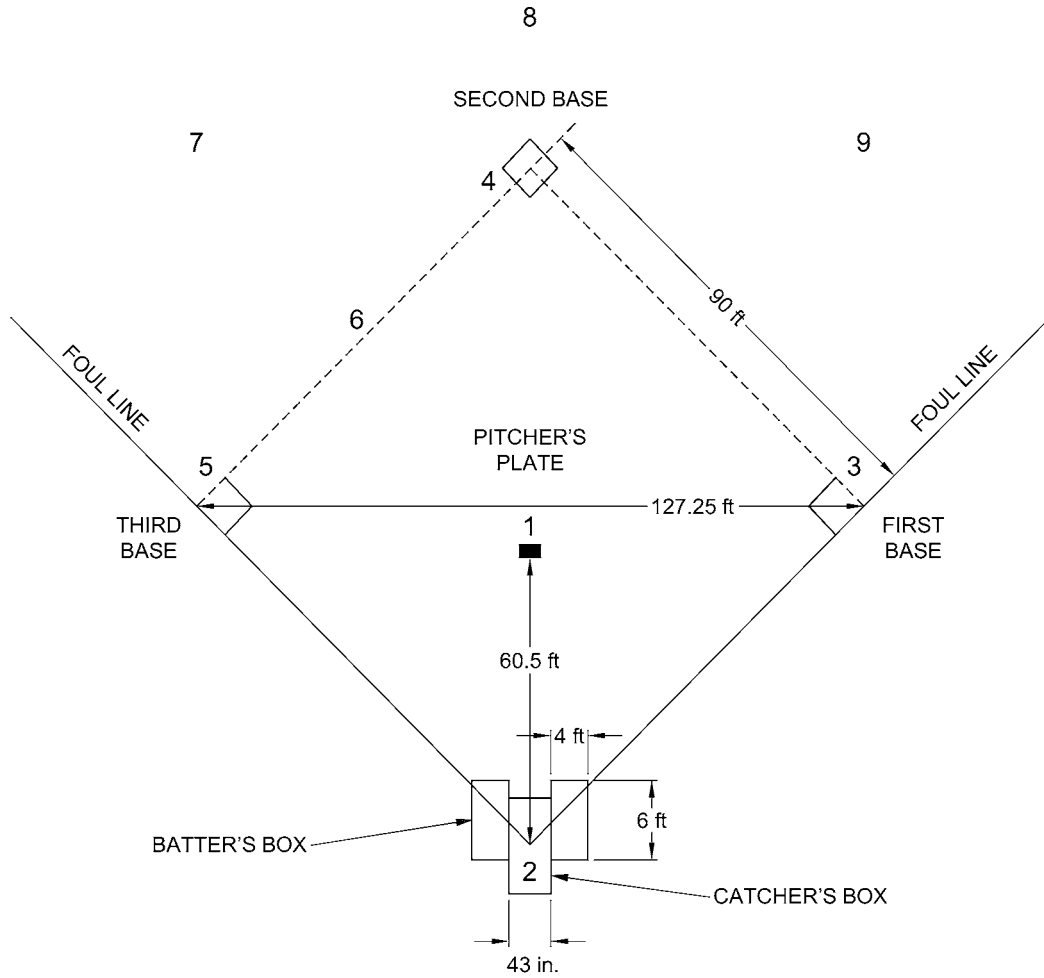

LEGEND

- 1. Pitcher
- 2. Catcher
- 3. First Baseman
- 4. Second Baseman
- 5. Third Baseman
- 6. Shortstop
- 7. Left Fielder
- 8. Centre Fielder
- 9. Right Fielder

The Sports Rules Book: Essential Rules for 54 Sports

Figure 5B-1 Baseball Diamond

BASKETBALL	
Objective: To pass the basketball through the opposing teams' basket in order to obtain the most points at the end.	
Scoring: Each successful basketball in a basket will be awarded with two or three points. Those shots taken from within the three-point line will be scored as two points, and those shots taken at or beyond the three-point line will be awarded three points (see Figure 5B-2).	
Definitions:	
Dribble	Dribbling consists of bouncing the ball on the floor, using only one hand at a time. This can be done while moving on the court or while the player is stationary. Once a player stops dribbling and holds the ball, they cannot dribble again until another player touches the ball.
Double Dribble	Dribbling with both hands at once is a violation that results in a turnover.
Rebound	When a player controls possession of a missed shot, either by a teammate or an opponent.
Pass	The movement of the ball by a player to another player by throwing, batting, or rolling the ball.
Pivot	When a player holding the ball pivots with one foot kept at a point of contact with the floor, while stepping in other directions with the other foot.
Traveling	When a player advances on the court with the ball without dribbling it.
Number of Players: Five players per team on the court at a time.	
Equipment Required:	
<ul style="list-style-type: none"> • Basketball x 1. • Gymnasium/outdoor court. 	<ul style="list-style-type: none"> • Nets x 2.
Basic Rules:	
<ul style="list-style-type: none"> • The game consists of two 20 minute halves. • The game begins with what is known as a "Jump Ball". Player from each team will meet face to face in at the centre of the court. Here the ball will be tossed straight up between them where both players will attempt to catch or hit the ball to a teammate. • Teams will consist of: point guard, off guard/shooting guard, small forward, power forward, and centre/post. • Once the game has begun the player in possession of the ball must dribble at all times in order to continue to move forward along the court. The player may pass the ball at any time to a teammate. • If a player in possession of the ball stops at any time they may only pivot on the spot or take a maximum of three steps and then pass or shoot the ball towards the basket. • If a team scores, the opposing team will gain possession. The team that was scored on begins under the net, with one player passing the ball to a teammate. 	

BASKETBALL

- During the game if the ball is tossed out of bounds or a person is fouled, the opposite team will gain the ball where a free throw will be awarded or a sideline pass takes place.

Further details on the sport of basketball can be found in *The Sports Rules Book: Essential Rules for 54 Sports* (1998), pp. 37-46.

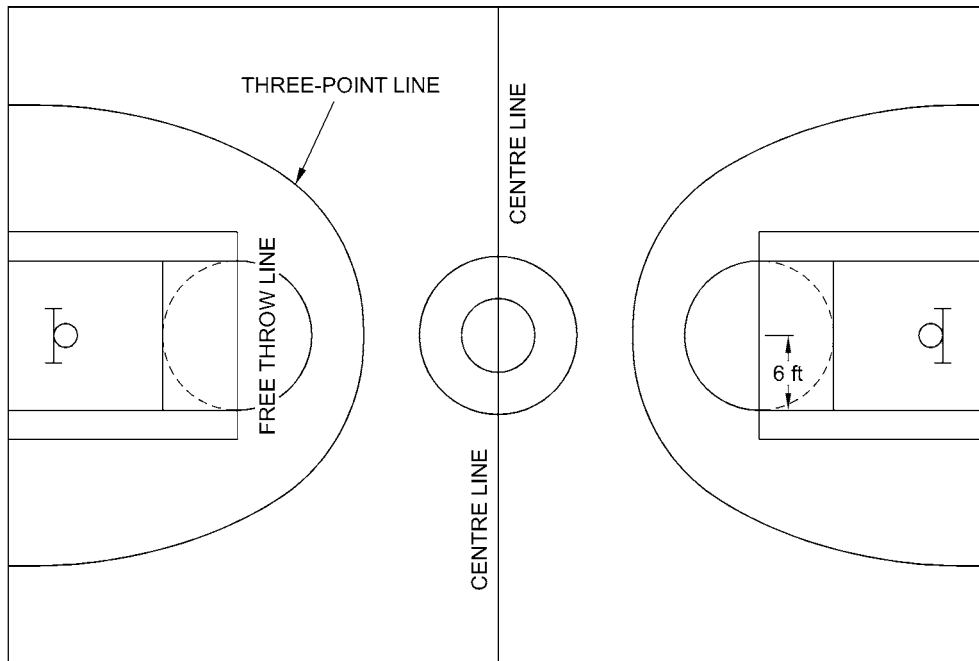

The Sports Rules Book: Essential Rules for 54 Sports

Figure 5B-2 Basketball Court

FOOTBALL (FLAG/TOUCH)	
Objective: Is an adaptation of football, where teams attempt to score as many points as possible through touchdowns. The team with the highest score at the end is the winner.	
Scoring: Touchdown – six points: <ul style="list-style-type: none"> When a player possesses the ball and the ball touches or crosses the plane of the opponent’s goal line. This can be accomplished by running the ball, catching a pass, or by recovering a fumble on or over the opponent’s goal line. Extra Points: <ul style="list-style-type: none"> One point if played from the five-yard line. Two points if played from the 12-yard line. Safety – two points. Note: An interception return to the opponent’s end zone on any extra-point play by the defence will result in the defence scoring two points plus they will gain possession for the next series at their own five-yard line.	
Definitions:	
Dead Ball	When the ball is dead and the play is over.
First Down	Is a new set of four downs. Each team gets four downs when they are playing offence, in which to make a play.
Fumble	When a player loses possession of the ball while the play is still in progress.
No-running Zones	Located five-yards from each end zone. When the ball is on or inside this five-yard line going towards the opponent’s end zone, the offence cannot use a running play to cross the scrimmage line.
Scrimmage Line	The point where the players line up for the snap.
Touchback	Occurs when a ball is dead on or behind a team’s own goal line, provided the ball’s force came from an opponent and it is not a touchdown.
Number of Players: Five players per team on the field at one time.	
Equipment Required:	
<ul style="list-style-type: none"> Football x 1. Field. 	<ul style="list-style-type: none"> Safety/protective equipment.
Basic Rules:	
<ul style="list-style-type: none"> The game consists of two 25-minute halves. One team takes first possession of the ball. This team becomes the offensive team and takes possession of the ball at their five-yard line. They have three plays to cross the midfield. Once they cross midfield, they have three plays to score a touchdown. 	

FOOTBALL (FLAG/TOUCH)

- If the offensive team fails to score, possession of the ball changes and the new offensive takes possession of the ball at their five-yard line.
- The team that plays defence at the start of the first half gets possession at the start of the second half.
- If a team fails to make it across midfield within three plays, possession of the ball changes.
- An automatic first down by penalty overrules the requirements regarding the three plays to make either the first down or score. Possession goes to other team.
- To start the play, the ball must be snapped between the legs of the snapper, who is also the centre. The ball is snapped back to the quarterback.
- The centre cannot take a handoff back from the quarterback after the ball is snapped.
- The quarterback cannot run with the ball past the scrimmage line.
- All defensive players are allowed to rush once the ball has been handed off or tossed, or if there has been a play-action fake or fake handoff.
- The quarterback only has seven seconds to throw the ball or the play is dead.
- Players are not allowed to catch a pass if their flag has fallen off in flag football.
- Must be played as **non-contact**. Blocking and tackling are not allowed.

Further details on the sport of football can be found in *The Sports Rules Book: Essential Rules for 54 Sports* (1998), pp. 125-136. These rules then must be adapted for flag/touch football, some of the modifications of which can be found on pp. 132-133. Information on flag football can also be found at www.slam.canoe.ca/FlagFootball/Rules/home.html.

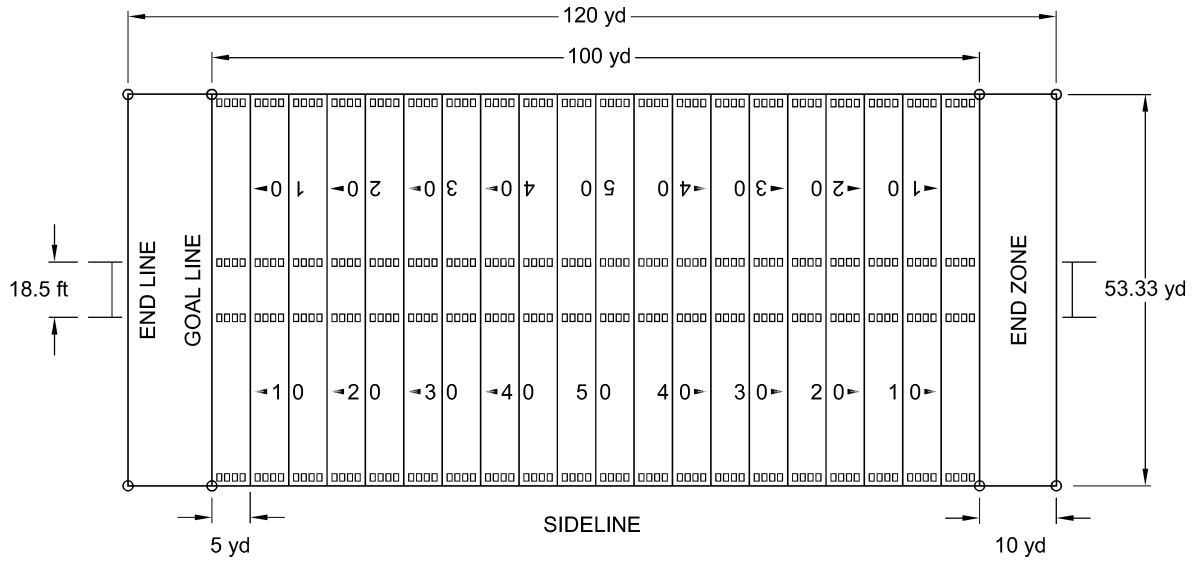

The Sports Rules Book: Essential Rules for 54 Sports

Figure 5B-3 Football Field

FLOOR HOCKEY

Objective: To pass the ball into the opposing teams net, between the posts, and under the cross bar of the opponent's goal in order to obtain the most points at the end.

Scoring: A player passing the ball through the net off their stick scores a goal. The team with the highest score at the end of the third period is the winner.

Definitions:

Face-off	When two players meet to try to gain possession of the puck when dropped by the referee.
Goal	A point/goal is scored when a player gets the ball across the goal line.
Rebound	A puck that bounces off the goalkeeper or the goal post.
Save	When the goalkeeper prevents a goal from being scored.

Number of Players: Six players per team on the floor at one time.

Equipment Required:

- | | |
|--|---|
| <ul style="list-style-type: none">• Hockey ball x 1.• Hockey sticks x number of players.• Goalie sticks x 2. | <ul style="list-style-type: none">• Goalie equipment, such as scoop, face mask, etc.• Hockey nets x 2. |
|--|---|

Basic Rules:

- A game consists of three 20-minute periods.
- A game begins with a face-off between two opposing players where an official drops the ball at the centre of the sporting venue.
- Teams will consist of a goalkeeper/goalie, three forwards – centre, left wing, and right wing, and two defencemen.
- Players advance toward the ball while running with the ball or passing it to fellow teammates. The ball must be in motion at all times.
- Every time a goal is scored, the players return to the initial set-up for a face-off at centre.
- If an attacker in the team's attacking zone cause the play to stop, a face-off will occur at the nearest face-off spot in the neutral zone.
- If a defender in the team's defensive zone causes the play to stop, a face-off occurs at the point of stoppage.

Further details on the sport of hockey can be found in *The Sports Rules Book: Essential Rules for 54 Sports* (1998), pp. 159-168. These rules then must be adapted for floor hockey.

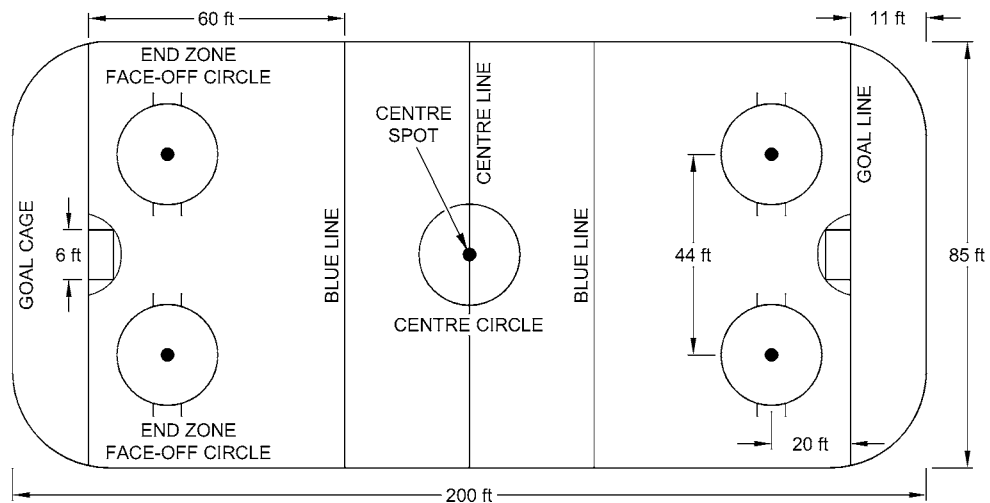

The Sports Rules Book: Essential Rules for 54 Sports

Figure 5B-4 Hockey Set-up

LACROSSE (WOMEN'S RULES)

Objective: To pass the ball into the opposing team's goal in order to obtain the most points at the end.

Scoring: A goal is scored when the ball passes completely over the goal line, between the posts, and under the cross bar of the opponent's goal.

Definitions:

Blocking	Occurs when one player moves into the path of an opponent with the ball without giving the opponent a chance to stop or change direction without contact.
Critical Scoring Area	An area at each end of the field, where the attacking team shoots for a goal.
Deputy	A player on the defensive goalkeeper's team who may enter the goal circle when his or her team is in possession of the ball and the goalkeeper is out the goal circle.
Free Space to Goal	The path to the goal within the critical scoring area.
Marking	Guarding an opponent within a stick's length.
Penalty Lane	The path to the goal that is cleared when a free position is awarded to the attacking team within the critical scoring area in front of the goal line.
Pick	A technique used by a player without the ball to force an opponent to take a different direction. The player must give the opponent time to see the pick and react to it.
Throw	The players stand one metre apart; the umpire, stands four to eight metres away, and throws the ball into the air and the players take it as they move toward the field. No other player can be within four metres of the players at the throw.

Number of Players: Twelve players per team on the field at one time.

Equipment Required:

- | | |
|--|--|
| <ul style="list-style-type: none"> • Ball x 1. • Field crosse's x number of players. • Goalkeeper's crosse x 2. | <ul style="list-style-type: none"> • Goalkeeper's helmet, face mask, and throat and chest protector x 2. • Mouth guards x number of players. |
|--|--|

Basic Rules:

- The game is usually 60 minutes in length and is split into halves.
- The game begins with a draw with two opposing players toeing the centreline, holding their crosses in the air, parallel to the centreline. The umpire places the ball between the players and when they call ready the players pull their sticks up and away, lifting the ball into the air. All other players must be outside the centre circle for the draw.
- The team in possession of the ball attempts to score goals by advancing the ball down the field. This can be done by carrying, throwing, rolling, or batting it.
- If the ball goes out of bounds, it is given to the closest player. If two players of opposing teams are an equal distance from the ball, the game is continued with a throw.

LACROSSE (WOMEN'S RULES)

- Only one player can be in the goal circle at a time. This can only be the goalkeeper or the deputy.
- Within the goal circle, the goalkeeper must clear the ball within 10 seconds. This can be done with the goalkeeper's crosse or hands and body.
- After each goal, the ball is put back into play with a draw.

Further details on the sport of lacrosse can be found in *The Sports Rules Book: Essential Rules for 54 Sports* (1998), pp. 179-186.

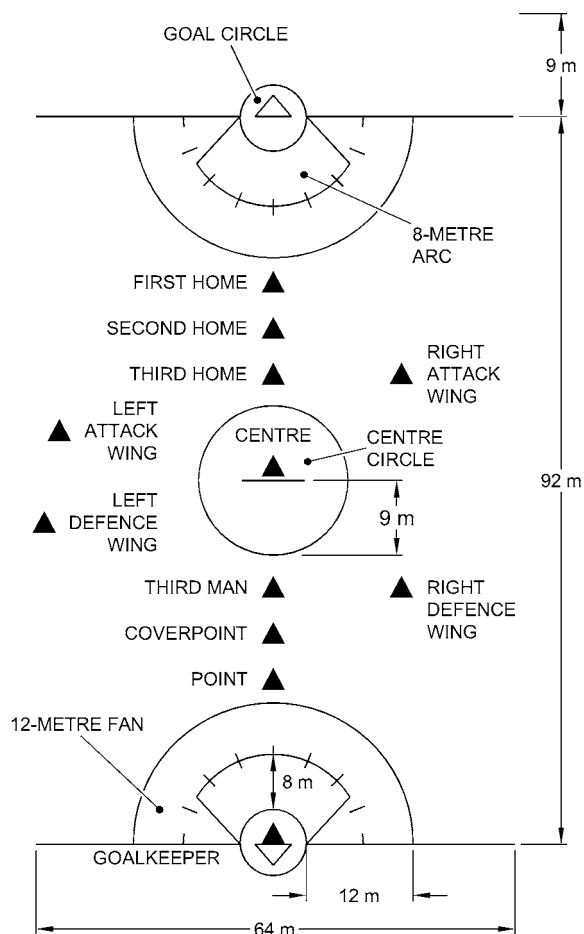

The Sports Rules Book: Essential Rules for 54 Sports

Figure 5B-5 Lacrosse Field

RINGETTE (OFF ICE VERSION)

Objective: To get the ring in the opposing team's net, between the posts, and under the cross bar of the opponent's goal in order to obtain the most points at the end.

Scoring: One point for every time a player gets the ring in the opposing team's net.

Definitions: N/A.

Number of Players: Six players per team on the floor at one time.

Equipment Required:

- | | |
|--|---|
| <ul style="list-style-type: none">• Nets x 2.• Safety equipment.• Rubber ring. | <ul style="list-style-type: none">• Straight sticks x number of players.• Goalkeeper's sticks x 2.• Goalkeepers mask. |
|--|---|

Basic Rules:

- Play begins with the visiting team being given a free centre free pass circle (which is like a face off circle in hockey).
- Teams consist of a goalkeeper/goalie, two defencemen, and three forwards.
- The ring is passed up the sporting venue similar to that in hockey in order to get the ring in the opposing team's goal.
- Free passes are used in ringette to restart play. The ring is placed in the free pass circle for this and one player gets to take possession, having five seconds to pass the ring to a teammate. Shots on goal are allowed from the free pass.
- The stick is placed inside the ring to play, not just on the outside like playing hockey.
- If the ring is within the goal crease the only player who is allowed to touch it is the goalie. The goalie usually will pick up the ring and throw it like a frisbee to a teammate but it cannot be thrown beyond the blue line. However, the goalie may also hit it with a stick or their foot.

Further details on the sport of ringette can be found at www.ringette.ca.

TEAM A'S DEEP DEFENSIVE ZONE

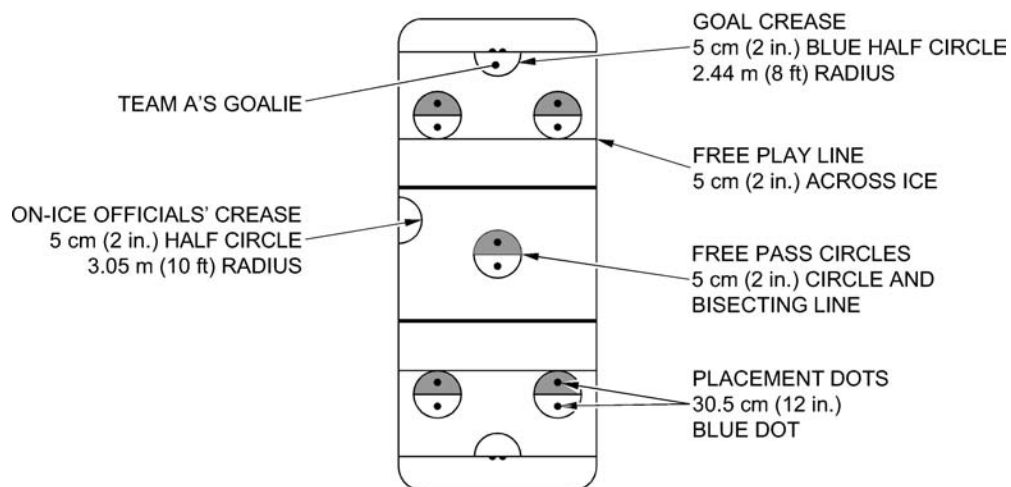

TEAM A'S DEEP OFFENSIVE ZONE

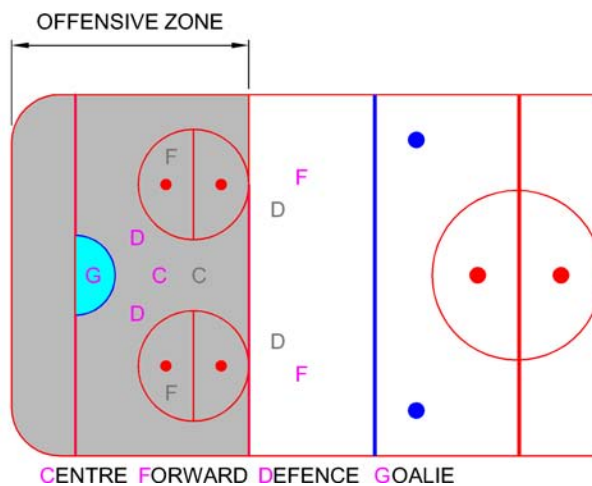

www.ringette.ca

Figure 5B-6 Ringette Ice/Sporting Venue

SOCCER

Objective: To pass the soccer ball into the opposing team's net, between the posts, and under the cross bar of the opponent's goal in order to obtain the most points at the end.

Scoring: One point is scored for every goal made into the opposing team's net, which completely crosses the goal line.

Definitions:

Corner Kick	Awarded to the opposing team when players kick the ball over their own goal line. All opposing players must be at least 10 yards from the ball for a corner kick.
Dribble	To move the ball with the feet in a continuous motion by passing the ball from one foot to the other.
Foul	Results in a direct or indirect free kick for the opposing team at the spot where the foul occurred.
Goal Kick	Occurs when a player kicks the ball over the opposing team's goal line. The opposing team is awarded the goal kick. Opposing players must be outside the penalty box area; either the goalkeeper or another player may kick the ball. It must be kicked beyond the penalty box area to be put into play. The player who performs the goal kick cannot touch the ball again until another player has done so.
Heads the Ball	When a player hits the ball with their head.
Penalty Kick	Is awarded to a team when an opposing player commits an intentional foul. All players except the kicker and the goalkeeper must stand outside the penalty area, at least 10 yards from the ball. The goalkeeper must stand on the goal line and not move their feet until the kick is made. If a goal is not scored and the ball goes out of bounds after being touched by the goalkeeper, the attacking team gets a corner kick.
Throw-in	Is awarded to a team when the ball goes over the sideline and was last touched by an opponent. A player throws the ball in from over their head, keeping both feet on the ground while releasing the ball. At least part of each foot must be on or behind the sideline.

Number of Players: Up to 11 players per team on the field at one time.

Equipment Required:

- | | |
|---|---|
| <ul style="list-style-type: none"> • Soccer ball x 1. • Nets x 2. | <ul style="list-style-type: none"> • Field or gymnasium. |
|---|---|

Basic Rules:

- The game consists of two 45-minute halves.
- The game begins with a kick off at the centre of the sporting venue.
- Teams consist of: the goalkeeper, defenders, midfielders, and forwards, or strikers.
- All players must be on their own half of the sporting venue before the kick off takes place. The player who kicks off may not touch the ball again until another player has.

SOCCER

- Players have to move the ball up the field with their feet, head, or chest. They may not touch the ball with their hands.
- The game continues in this manner, with players dribbling the ball and moving it toward the opposing teams goal in order to score.
- A goal may not be scored directly off a kick off, goal kick, or throw-in.

Further details on the sport of soccer can be found in *The Sports Rules Book: Essential Rules for 54 Sports* (1998), pp. 237-245.

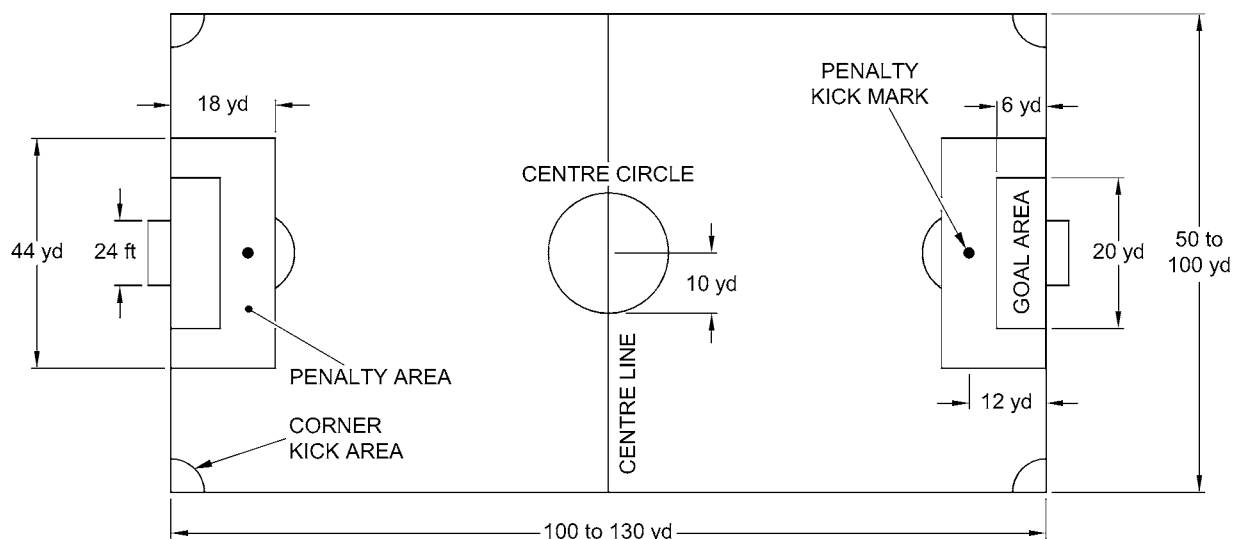

The Sports Rules Book: Essential Rules for 54 Sports

Figure 5B-7 Soccer Field

SOCCER BASEBALL/KICKBALL

Objective: While trying to prevent the opposing team from scoring runs, each team tries to score as many runs as possible. A run is scored when a team's player runs (in a counterclockwise direction) and steps on all three bases and the home plate, which is also known as completing the circuit. A game lasts nine innings where the team with the highest score wins, unless there is a tie. In that case the game will continue for additional innings until a team scoring an additional run breaks the tie (www.angelfire.lycos.com).

Scoring: One point is awarded as a member completes a circuit around the bases.

Definitions:

Double	A hit in which the batter safely reaches the second base.
Double Play	When two outs are made on the same play.
Force Play	Occurs when a runner is forced to advance to the next base because the batter becomes a runner.
Foul Play	Any ball hit into foul territory.
Foul Territory	The area outside the foul lines.
Home Run	When a batter hits a fair ball over the fence or circles the bases on a ball that was hit inside the fence.
Lead Off	When a runner leads off a base before the ball has left the pitcher's hand.
Legal Touch	This results in an out, when a defensive player tags a runner with the ball while the runner is not on a base.
Out	An out can be given due to strikeout, force-out, tag-out, and fly-out.
Steal	When a runner attempts to steal a base during a pitch to the kicker.
Tag-up Rule	If the ball is caught in the air after the kicker has kicked it, the kicker is out. As well, other players who are on bases must touch the base they were on after the ball is caught before they can run to the next base.

Number of Players: Eight players per team on the field at one time while not batting.

Equipment Required:

- | | |
|--|---|
| <ul style="list-style-type: none"> • Soccer ball x 1. • Baseball/softball field or a gymnasium or field. | <ul style="list-style-type: none"> • Bases/pylons x 4. |
|--|---|

Basic Rules:

- The game consists of five innings, with three outs per inning (for each team).
- One team takes the field first, taking up the various positions, to include: pitcher, catcher, first baseman, second baseman, third baseman, shortstop, left fielder, centre fielder, right fielder, and other fielders dependent on the number of players.

SOCCER BASEBALL/KICKBALL

- When pitching, the ball must touch the ground at least once and cannot be higher than one foot above the plate when it gets to the kicker. The ball should be pitched to roll as smoothly as possible.
- A ball is put into play once the pitcher rolls the ball toward home plate and the kicker has attempted to kick the ball.
- The kicker must wait for the ball to be within 3 ft of the home plate before they can attempt to kick the ball.
- Leading off and stealing of bases are not allowed.
- Bunts are not permitted.
- The kicker at home plate must kick the ball with the leg or foot, below the knee.
- Field players can tag the runner out while either carrying the ball or throwing it at the runner and making contact. Thrown balls are to hit below the waist.
- A runner who leaves their base before the pitch reaches home plate or is hit, is out and the ball is considered dead.

Further details on the sport of soccer baseball/kickball can be found at www.stanford.edu/group/Intramurals/kickballrules.html or www.kickball.com.

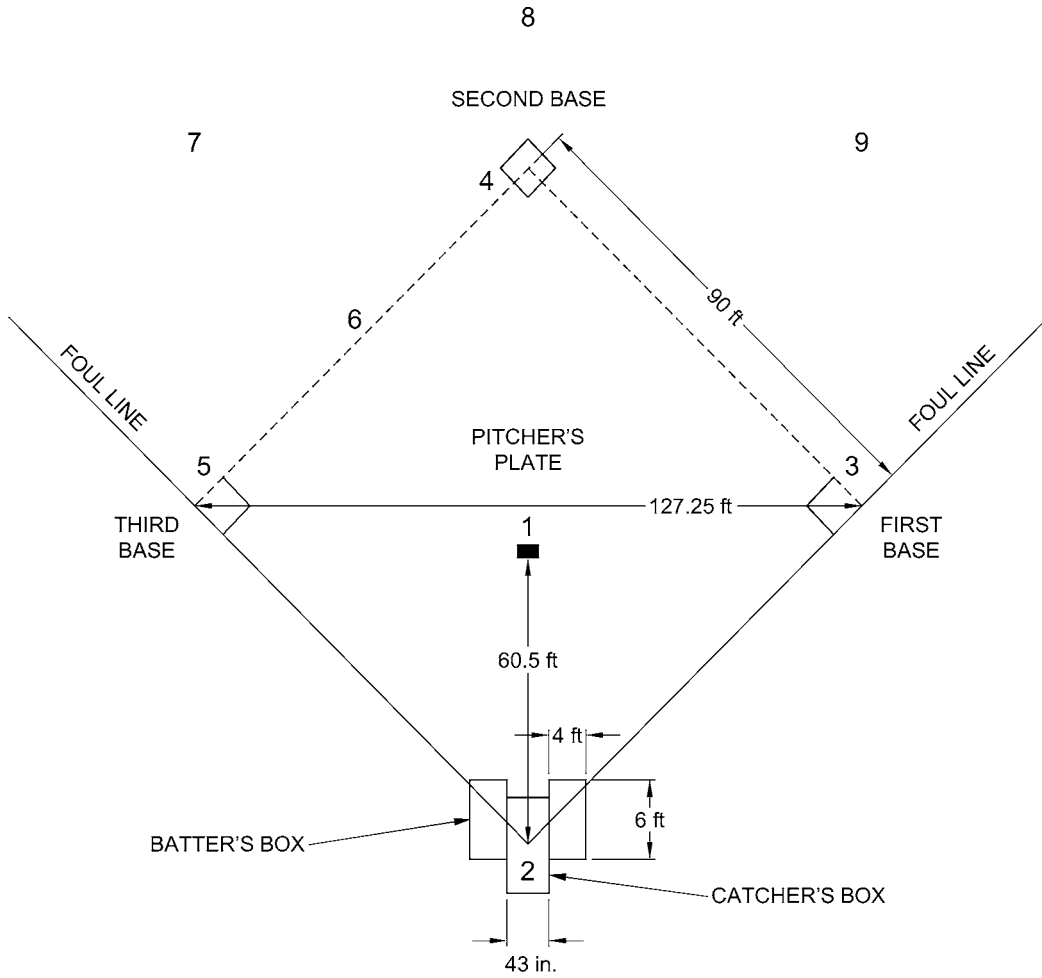

LEGEND

- 1. Pitcher
- 2. Catcher
- 3. First Baseman
- 4. Second Baseman
- 5. Third Baseman
- 6. Shortstop
- 7. Left Fielder
- 8. Centre Fielder
- 9. Right Fielder
- 10. Extra Fielder

The Sports Rules Book: Essential Rules for 54 Sports

Figure 5B-8 Baseball Diamond (Can Be Used for Soccer Baseball)

SOFTBALL

Objective: While trying to prevent the opposing team from scoring runs, each team tries to score as many runs as possible. A run is scored when a team's player runs (in a counterclockwise direction) and steps on all three bases and the home plate, which is also known as completing the circuit. A game lasts nine innings where the team with the highest score wins, unless there is a tie. In that case the game will continue for additional innings until a team scoring an additional run breaks the tie (www.angelfire.lycos.com).

Scoring: One point is awarded as a member completes a circuit around the bases.

Definitions:

Ball	A ball is when the pitch is not within the strike zone.
Bunt	When a batter hits the ball by letting the ball meet the bat to drop as a soft ground ball on the infield.
Double Play	When two outs are made on the same play.
Fake Tag	Is a form of obstruction of a runner by a fielder who neither has the ball nor is about to receive it. The umpire will award the runner the base they would have made, if the obstruction had not been made.
Fly Ball	A ball batted high into the air.
Fly-out	Is a fly ball that is caught before it touches the ground or the fence.
Force Play	Occurs when a runner is forced to advance to the next base because the batter becomes a runner.
Foul Play	Any ball hit into foul territory.
Foul Territory	The area outside the foul lines (see Figure 5B-9).
Home Run	When a batter hits a fair ball over the fence or circles the bases on a ball that was hit inside the fence.
Inning	An inning consists of a top and a bottom. During either the top or bottom half each team will get the opportunity to bat and field accordingly.
Interference	This occurs when an offensive player impedes or confuses a defensive player as they are trying to make a play. Interference can be physical or verbal.
Lead Off	When a run leads off a base in fast-pitch when the ball has left the pitcher's hand. In slow-pitch, a runner may not leave the base until the ball has been batted, touches the ground, or reaches home plate, but must return to the base if the ball is not hit.
Legal Touch	This results in an out, when a defensive player tags a runner with the ball while the runner is not on a base.
Out	An out can be given due to strikeout, force-out, tag-out, and fly-out.
Overslide	When a player overslides first base when running. It is allowed at first base, but at second and third base the runner may be tagged out.

SOFTBALL

Steal In fast-pitch, a runner may attempt to steal a base during a pitch to the batter.

Walk A batter is awarded first base if a pitcher pitches four “balls”.

Number of Players: Ten players per team on the field at a time if team is not batting.

Equipment Required:

- | | |
|---|--|
| <ul style="list-style-type: none">• Bases x 4.• Bat.• Batter’s helmets. | <ul style="list-style-type: none">• Softball.• Various gloves x number of players.• Baseball/softball field. |
|---|--|

Basic Rules:

- The game consists of seven innings, with three outs per inning (for each team).
- One team takes the field first, taking up the various positions, to include: pitcher, catcher, first baseman, second baseman, third baseman, shortstop, left fielder, centre fielder, right fielder, and extra fielder.
- The other team bats first in the top half of the inning, according to the batting order for their players.
- The pitcher attempts to get the batter out, preventing them from reaching first base and the subsequent bases.
- The pitcher **must** use an underhand pitch.
- A batter is out if they receive three strikes or if they hit the ball but it is caught by someone in the field before it hits the ground.
- The batters objective is to get around the bases without being tagged and before the ball reaches the base. A team scores a run when a player has safely touched first, second, and third base, and has made it back home or hits the ball over the fence.

Further details on the sport of softball can be found in *The Sports Rules Book: Essential Rules for 54 Sports* (1998), pp. 247-259.

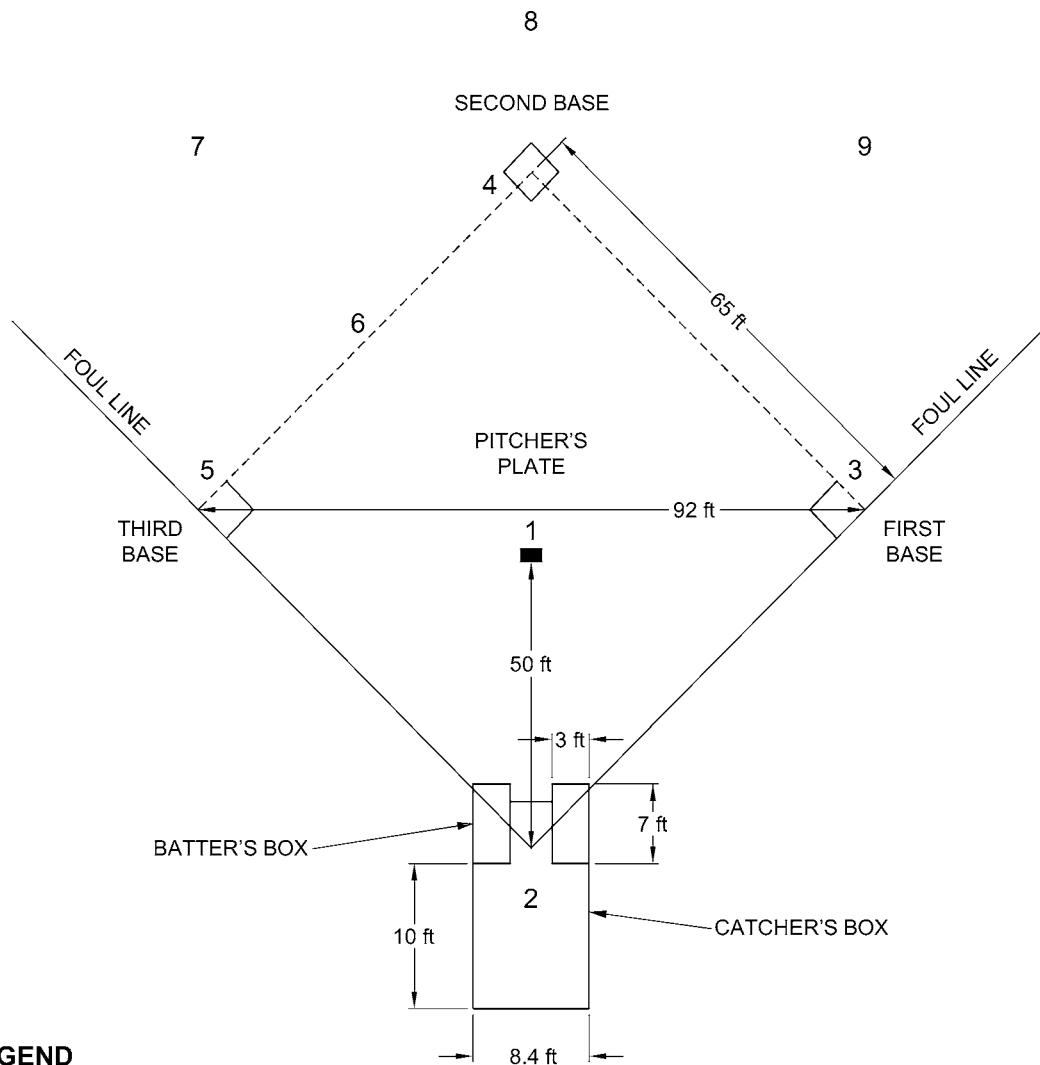

LEGEND

- 1. Pitcher
- 2. Catcher
- 3. First Baseman
- 4. Second Baseman
- 5. Third Baseman
- 6. Shortstop
- 7. Left Fielder
- 8. Centre Fielder
- 9. Right Fielder
- 10. Extra Fielder

The Sports Rules Book: Essential Rules for 54 Sports

Figure 5B-9 Softball Field

ULTIMATE FRISBEE

Objective: To score by catching a pass in the opponent's end zone in order to obtain the most points at the end.

Scoring: Points are awarded to a team when a player catches a pass in the opponent's end zone. A typical game is scored to 15 points.

Definitions:

Clearing	To get out of the area where the thrower wants to pass the disc.
Cut	An attempt to get free of other players in order to receive a pass.
Force	To make it difficult for the thrower to throw the disc in a certain direction in an attempt to try to get them to pass it the other way.
Huck	A long pass that is nearly the length of the field and is high.
Layout	When a player dives to catch or intercept the disc.
Poach	When a defender moves away from their marker to try to intercept a pass to another player.
Swing	A lateral pass across the pitch, instead of upfield.
Switch	When two defenders exchange the offensive players they were marking.

Number of Players: Seven players per team on the field at one time.

Equipment Required:

- | | |
|---|--|
| <ul style="list-style-type: none">• Plastic disc (frisbee) x 1. | <ul style="list-style-type: none">• Pylons to mark boundaries. |
|---|--|

Basic Rules:

- Each team lining up on the front of their respective end zone line initiates play. The defence throws the disc to the offence.
- The disc may be played in any direction by passing to teammates. Players must remain stationary when they hold the disc. It must be passed to other players on the field that is closer to the opponent's end zone.
- A player may not hold the disc for longer than 10 seconds. The defender who is guarding the player holding the disc (staller) must count out the stall count.
- When a pass is not completed due to out of bounds, being dropped, blocked or intercepted, etc., the defence takes possession of the disc and becomes the offence.
- To bring the disc back into play it must be brought to the point on the pitch where it went out, or the nearest point where a defender touched it.
- There is no physical contact allowed between the players.
- A throw can be made without stopping if it is within three steps of the catch. The thrower cannot change direction or speed up after catching the disc.

Further details on the sport of ultimate frisbee can be found at www.whatisultimate.com or www.upa.org/ultimate.

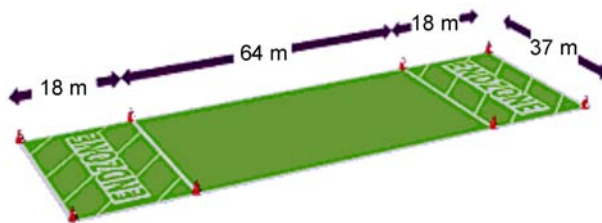

www.whatisultimate.com

Figure 5B-10 Ultimate Frisbee Field

VOLLEYBALL

Objective: To gain points by hitting the ball into the opposing team's portion of the court in order to obtain the most points at the end.

Scoring: One point is awarded every time the ball hits inside the boundary lines of the opposing teams court; the opponents are unable to return the serve within three hits; the opponents hit the ball out of bounds; or the opponents commit a fault or foul when the team was the serving team.

Definitions:

- | | |
|----------------|--|
| Attack Hit | A hit aimed into the opponent's court. |
| Attack Lines | These separate each side of the court into a front zone and a back zone. |
| Block | Occurs when one or more players stop the ball before, or just after, it crosses the net. |
| Rally | The exchange of hits back and forth between the teams. The team that wins the rally gets the serve. |
| Rotation Order | Each team has a rotation order that must be kept when it gains the serve. Each time it gains a serve, players rotate one position clockwise. |

Number of Players: Six players per team on the court at one time.

Equipment Required:

- | | |
|--|---|
| <ul style="list-style-type: none"> • Volleyball x 1. • Volleyball net x 1. | <ul style="list-style-type: none"> • Volleyball court. |
|--|---|

Basic Rules:

- The game continues until a team scores 15 points and has a two-point advantage.
- The team has three players on the front of the court and three on the back of the court.
- Players may hit the ball with their hands clasped together and can strike the ball overhand, underhand, and with either an open or closed fist.
- One team will start the serving, the other receiving. A player retains the serve until the other team wins the right to serve.
- Upon completing the serve a team must rotate positions.
- The server may stand anywhere behind the end line to serve.
- A service fault occurs if the ball touches a player of the serving team; fails to pass through the crossing space over the net; touches the net or any other object; or lands out of bounds.
- Only the team, which serves, can score points.
- If the team that is serving stops their opponents from scoring, they are then awarded the serve.
- Each team has three hits in order to get the ball over the net to return the ball. This is in addition to blocking.
- A ball may still be in play if it touches the net, except on the serve.

Further details on the sport of volleyball can be found in *The Sports Rules Book: Essential Rules for 54 Sports* (1998), pp. 325-334.

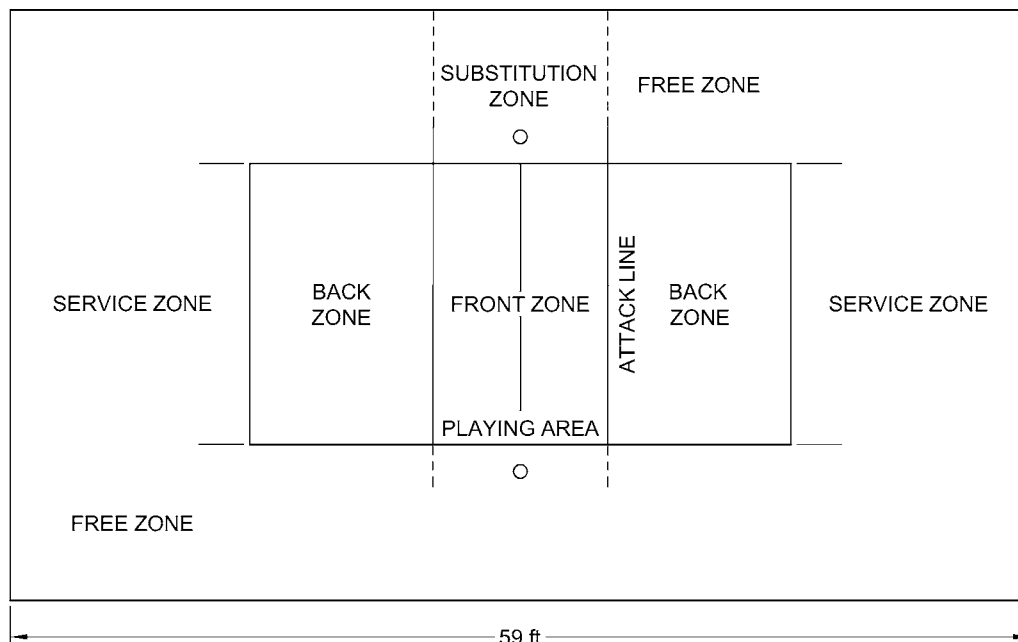

The Sports Rules Book: Essential Rules for 54 Sports

Figure 5B-11 Volleyball Court

REFERENCES

(ISBN 0-88011-807-5) Human Kinetics with Thomas Hanlon (1998). *The Sports Rules Book: Essential Rules for 54 Sports*. USA: Human Kinetics Publishers, Inc.

Ringette Canada. Retrieved 27 April 2006, from www.ringette.ca.

Ultimate. Retrieved 27 April 2006, from www.whatisultimate.com.

Stanford Intramurals, Department of Athletics, Physical Education and Recreation. Retrieved 30 April 2006, from www.stanford.edu/group/Intramurals/kickballrules.html.

NFLCANADA.COM. Retrieved 30 April 2006, from www.slam.canoe.ca/FlagFootball/Rules/home.html.

Ultimate Players Association. Retrieved 27 April 2006, from www.upa.org/ultimate.



World Adult Kickball Association (WAKA). Retrieved 1 May 2006, from www.kickball.com.

SAMPLE STRETCHES

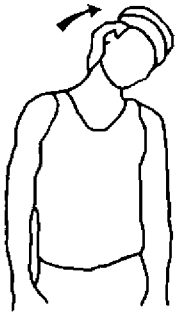
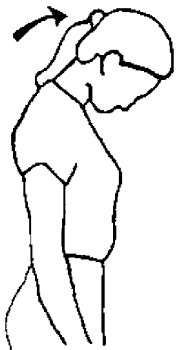

Neck

 <p>www.womensheart.org/content/Exercise/stretching_exercise.asp</p> <p>Figure 5C-1 Neck Stretch</p>	<p>Slowly stretch your neck so your head turns toward your left shoulder, hold. Repeat on opposite side. Hold for 10 to 30 seconds.</p> <p>There should be no swivelling motion of the neck.</p>
 <p>www.womensheart.org/content/Exercise/stretching_exercise.asp</p> <p>Figure 5C-2 Neck Stretch</p>	<p>Slowly stretch your neck so your head tilts toward your left shoulder, hold. Repeat on opposite side. Hold for 10 to 30 seconds.</p> <p>Drop your head toward your chest, stretching the back of your neck. Hold for 10 to 30 seconds.</p>
 <p>www.womensheart.org/content/Exercise/stretching_exercise.asp</p> <p>Figure 5C-3 Back of Neck Stretch</p>	<p>Drop your head toward your chest, stretching the back of your neck. Hold for 10 to 30 seconds.</p>

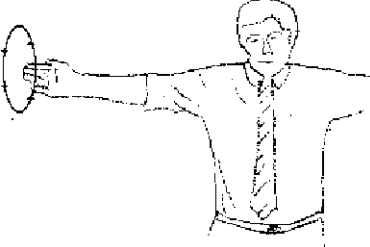
Shoulders

 <p>10 SECONDS</p> <p>www.walkablock.com/stretch2.gif</p> <p>Figure 5C-4 Shoulder Push</p>	<p>Stand, extend your arms down and behind, and interlock your fingers. Push up and back with your shoulders. Hold for a minimum of 10 seconds.</p>
 <p>www.shelterpub.com/_fitness/online_stretches.gif</p> <p>Figure 5C-5 Shoulder Shrugs</p>	<p>Stand and raise your shoulders as high as possible and then lower your shoulders, stretching your neck. Pull your shoulders back as far as possible and then round your shoulders forward by pulling your arms forward as far as possible. Hold each movement for approximately 10 seconds.</p>
 <p>www.eeshop.unl.edu</p> <p>Figure 5C-6 Arm Rotators</p>	<p>Hold arms straight out from your sides, palms up. Bring each arm under and around using small circles and gradually increasing the size of the circles. Reverse and repeat.</p>
<p>Shoulder Stretch – No Diagram</p>	<p>Standing or sitting, take your right arm in your left hand and bring it across the chest, supporting the joint by holding it behind the elbow. Pull lightly on the elbow toward the chest. You should feel the stretch in your right shoulder. Hold for 30 seconds, switch sides, and repeat on both sides.</p>



Arms

 <p>www.shelterpub.com/_fitness/online_stretches.gif Figure 5C-7 Wrist Rotations</p>	<p>Rotate your hands around in circular motions from the wrist. Rotate and repeat in each direction.</p>
 <p>www.walkablock.com/stretch2.gif Figure 5C-8 Triceps Stretch</p>	<p>Stand and bring your right arm overhead, flexed at the elbow. Use your left hand to gently pull the arm down. Hold for a minimum of 10 seconds and relax. Reverse arms and repeat.</p>
<p>Forearm Stretch – No Diagram</p>	<p>Kneel down with toes bent and place your hands on the floor in front of you with your fingers facing your knees, thumbs pointed out. While keeping your hands flat on the floor, lean back. Hold for 30 seconds and repeat.</p>

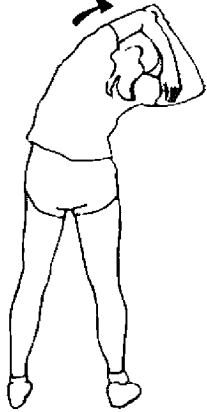
Chest and Abdominals

<p>Chest Stretch – No Diagram</p>	<p>Stand facing a wall. Reach an arm out to the wall at shoulder height with palm against the wall and thumb up, arm extended straight. Turn your body away from your extended arm. You should feel the stretch on the front side of your armpit and across the front of you chest. Hold for 30 seconds, switch sides, and repeat on both sides.</p>
 <p>www.womensheart.org/content/Exercise/stretching_exercise.asp</p> <p>Figure 5C-9 Side Stretch (Oblique)</p>	<p>Stand with your left arm up and bend at the waist to the right side of the body. Support your elbow with your opposite hand. Hold for 20 seconds. Reverse sides and repeat on both sides.</p>

Back

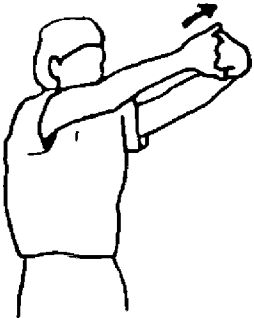
 <p>www.losethebackpain.com</p> <p>Figure 5C-10 Full Back Stretch</p>	<p>On your hands and knees, stretch the back upward and hold at its highest point for approximately 10 seconds. Return to starting position. Repeat.</p>
 <p>www.roadcycling.com/artman/upload/stretches.jpg</p> <p>Figure 5C-11 Lower Back Stretch</p>	<p>Lie on your back and bring your knees toward your chest. Hold just under your knees. Hold for 30 seconds and repeat.</p>
 <p>www.roadcycling.com/artman/upload/stretches.jpg</p> <p>Figure 5C-12 Back Stretch</p>	<p>Lie on your back with arms extended above your head. Cross your left leg over your right at hip level, keeping it straight. Keep your shoulders flat on the ground. Return to starting position, reverse, and repeat on both sides. Hold each position for 10 to 30 seconds.</p>
 <p>www.womensheart.org/content/Exercise/stretching_exercise.asp</p> <p>Figure 5C-13 Upper Back Stretch</p>	<p>Extend arms straight in front of you at shoulder height. Intertwine your fingers, then turn your palms facing outward (away from your body). Press out through your arms. Let your chin fall to your chest as you exhale. You should feel the stretch in the upper back. Hold for 30 seconds and then repeat.</p>

Hip and Groin

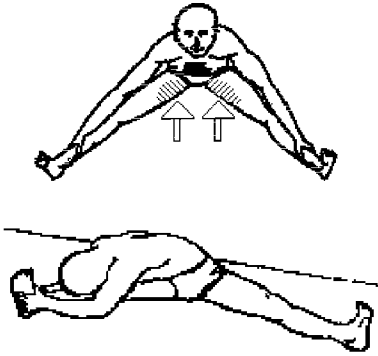

www.spineuniverse.com

Figure 5C-14 Hip and Groin Stretch

Sit on the floor with legs straight and spread apart as far as you can comfortably. With your back straight, lean forward as far as possible trying to push your chest toward the floor. Hold for 30 seconds.

Twist your body to face your right/left foot with your body over your right/left leg respectfully. Push your chest toward your knee, holding for 30 seconds. Switch sides; hold each position for 30 seconds. Repeat each movement.

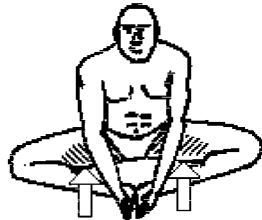

www.spineuniverse.com

Figure 5C-15 Hip and Groin Stretch

Sit on the floor with your knees bent out and the soles of your feet together.

Grab your toes and pull yourself forward while keeping your back and neck straight. Ensure you pivot from your hips and don't roll your back. Hold for 30 seconds and repeat.

Grab your ankles and push your knees down toward the floor with your elbows. Hold for 30 seconds and repeat.



www.womensheart.org/content/Exercise/stretching_exercise.asp

Figure 5C-16 Hip Stretch

While sitting on the floor in an upright position and legs out in front of you, bend your right knee, crossing it across your left leg, and place your left elbow against it. Place your right hand on the floor behind you while twisting your upper body. You must be cautious to keep your back straight. Hold for 20 to 30 seconds, switch sides, repeat on both sides.

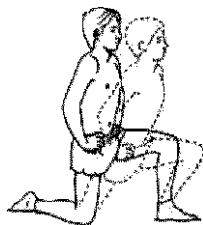

www.roadcycling.com/artman/upload/stretches.jpg

Figure 5C-17 Hip Flexor

Kneel on your right knee. Place your left foot in front of you, bending your knee and placing your left hand on that leg for stability. Place your right hand on your right hip to avoid bending at the waist. Keep your back straight and abdominal muscles tight. Lean forward, shifting more body weight onto your front leg. You'll feel a stretch in the front of the hip and thigh of the leg you're kneeling on. Cushion your kneecap with a folded towel. Hold the stretch for 30 seconds. Repeat the stretch on your left side.

Legs

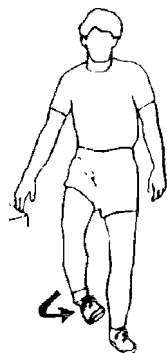

www.womensheart.org/content/Exercise/stretching_exercise.asp

Figure 5C-18 Ankle Rotations

From a standing position, rotate your foot in a clockwise and then counterclockwise direction. Switch sides and repeat on both sides.

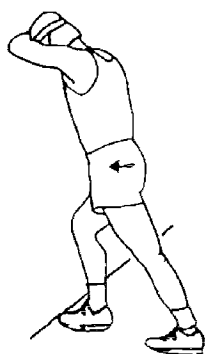

www.womensheart.org/content/Exercise/stretching_exercise.asp

Figure 5C-19 Calf Stretch

Take three steps away from a wall. Turn around and face the wall. Stand straight, with toes, hips, and shoulders all facing the wall. Step with your right leg in toward the wall, bending your right knee and keeping your left leg straight. Extend arms out; with palms forward, reach out to the wall and let your body fall toward the wall, arms straight. Keep toes forward and heels down. Lean your body into the wall with your left leg straight behind your body. You should feel the stretch in your left calf. Hold 30 seconds, switch sides, repeat on both sides.



www.womensheart.org/content/Exercise/stretching_exercise.asp

Figure 5C-20 Quadriceps Stretch

Stand straight with toes, hips and shoulders all facing forward. Lift your left foot off the ground, bending the knee as if you're trying to kick your bottom with your heel. Stand straight, do not lean forward at the hips. Grab and hold your ankle with your left/right hand and keep standing straight. You should feel this stretch in your left thigh. Hold 30 seconds, switch sides, and repeat on both sides.



www.womensheart.org/content/Exercise/stretching_exercise.asp

Figure 5C-21 Hamstring Stretch

Sit on the floor with your back straight and your right leg extended forward. Bend your right knee. Extend the arms forward and lean forward (back straight) slowly until you feel an easy stretch. Repeat several times and reverse sides. Hold for 10 to 30 seconds.

For more stretches, consult the following Websites:

- www.womensheart.org
- www.walkablock.com
- www.shelterpub.com
- www.eeshop.unl.edu
- www.losethebackpain.com
- www.roadcycling.com
- www.spineuniverse.com

SUGGESTED SPORTS TABLOID EVENTS

Sports Related Events

Name of Event	Brief Description	Suggested Points (pts)
Shuttle Toss	Each team member has to toss a badminton shuttle into a bucket a specified distance away. This continues until the time has elapsed.	2 pts for each successful shuttle.
Accuracy Throw	Each team member has to toss a bean bag, or similar item, into a ring of concentric circles with various point values. Circles can be made with masking tape on the floor. This continues until the time has elapsed.	5 pts for the inner ring, and so forth until the outer ring value is 1 pt.
Ball Over and Under	Team forms a line all facing in single file and passes a ball over and under until the end, then the last member runs to the front and starts it again. The first person in line passes the ball over their head and the next person passes it under their legs. This continues until the time has elapsed.	1 pt for each fully completed line (no point awarded if ball is dropped, and it must go back to the beginning).
Basketball Throw	Each team member has to shoot a basketball into the net from a point a specified distance away. This continues until the time has elapsed.	2 pts for each basket.
Volleyball Bump	Team stands in a circle and the volleyball has to be bumped from person to person continuously without it dropping on the floor until the time has elapsed.	1 pt for each time the ball is bumped successfully without it dropping.
Soccer Dribbling Obstacle Course	Set up a course with pylons and each member has to successfully dribble a soccer ball around the pylons and then pass the ball to the next person.	2 pts for each successful member.
Basketball Dribbling Obstacle Course	Set up a course with pylons and each member has to successfully dribble a basketball around the pylons and then pass the ball to the next person.	2 pts for each successful member.
Skipping	Each member of the team has to skip with a jump rope as many times as they can without stopping or getting caught up in the rope.	5 pts for each member who gets to a specified number (ex. 15 jumps) and 10 pts for an increased specified number (ex. 30 jumps).

Name of Event	Brief Description	Suggested Points (pts)
Running Long Jump	Tape or markers to be set up with points to be awarded depending on how far each member jumps.	Successive pts for various distances, to be marked on the tape or markers (ex. 2 pts for each member who gets beyond marker A and 5 pts for those beyond marker B).
Standing Long Jump	Tape or markers to be set up with points to be awarded depending on how far each member jumps.	Successive pts for various distances, to be marked on the tape or markers (ex. 2 pts for each member who gets beyond marker A and 5 pts for those beyond marker B).
Floor Hockey Goals	Each member of the team has to stand at a specified point and try to get a ball into a net with a floor hockey stick. One section of the net could be marked off for bonus points.	1 pt for every successful member and 3 pts if they get it in the bonus section.
Mini Obstacle Course	Set up a mini obstacle course that each member of the team has to successfully complete. This could include hurdling over benches, crawling under and over sturdy items, running through pylons, etc.	3 pts for each member who successfully completes the course.

Fun Events

Name of Event	Brief Description	Suggested Points (pts)
Egg/Candy Carry	Each member of the team has to carry an egg/candy on a spoon to a specified point and return without dropping the egg/candy, where in turn every cadet takes a turn doing the same.	1 pt awarded for each successful member.
Sweater Pull	First member of the team puts on a large sweater and runs to a specified point and back to the group where they join hands with the next member and two people pull the sweater from one person to the next which continues on until the end of the time limit for that event.	3 pts for each time the entire group completes.
Pantyhose Pull-on With Mittens/Oven Mitts	Each member of the team has to put pantyhose on over their pants while wearing mittens or oven mitts without tearing them.	2 pts for each successful member.
Boots Nailed to 2x4, Group Walks Together	Members of the team place their feet in the boots that are nailed to the planks, and the team has to walk together to a specified point.	2 pts for each successful attempt.
Three-legged Race	Two members tie their opposite feet together with a scarf and have to walk together to a specified point. Each successive pair continues.	2 pts for each successful pair.
Human Knot	Each member of the team stands in a circle with both arms up in the air. Then everyone closes their eyes, and slowly take one or two steps forward upon the word of the scorekeeper. Everyone taking the hands of other members. The idea is for everyone to untie the knot so that every member of the group is standing in a circle side by side, with the hands of the team members next to them.	5 pts for each successful knot being untied.

Name of Event	Brief Description	Suggested Points (pts)
Old Clothes Race	<p>From a pile of old clothes, each member of the team will have to put on old clothes over their own clothes and run to a specified point before returning to the team, taking it off and the next member has to put it on and do the same thing.</p> <p>Examples of old clothes that each member has to put on include: shorts or track pants, T-shirt, sweater, hat, scarf, mitts or gloves, etc.</p>	3 pts for each member who completes.
Orange in Pantyhose Relay Race	<p>One by one, each member of the team has to tie a pair of pantyhose around their waist that has an orange in the toe. With this they have to push another loose orange with the one in the pantyhose, up to and around a pylon and return to the starting point, where the next member of the team performs the same thing.</p>	1 pt for each successful member.

SPORTS TABLOID EVENTS EQUIPMENT LIST

Sports Related Events

Name of Event	Equipment Required
Shuttle Toss	<ul style="list-style-type: none"> • Bucket. • Badminton shuttles (minimum three). • Tape to mark line on floor for participant to stand.
Accuracy Throw	<ul style="list-style-type: none"> • Tape to mark concentric circles on floor. • Bean bags (minimum three) or other similar item to be thrown.
Ball Over and Under	<ul style="list-style-type: none"> • Ball (soccer ball or volleyball sized ball).
Basketball Throw	<ul style="list-style-type: none"> • Basketball net. • Basketball.
Volleyball Bump	<ul style="list-style-type: none"> • Volleyball.
Soccer Dribbling Obstacle Course	<ul style="list-style-type: none"> • Pylons or other similar type markers, such as chairs. • Soccer ball.
Basketball Dribbling Obstacle Course	<ul style="list-style-type: none"> • Pylons or other similar type markers, such as chairs. • Basketball.
Skipping	<ul style="list-style-type: none"> • Skipping rope.
Running Long Jump	<ul style="list-style-type: none"> • Tape to mark points on floor. • Tape or pylons to mark starting position.
Standing Long Jump	<ul style="list-style-type: none"> • Tape to mark points on floor. • Tape or pylons to mark starting position.
Floor Hockey Goals	<ul style="list-style-type: none"> • Floor hockey net. • Floor hockey stick. • Floor hockey ball (or similar ball). • Target for bonus area.
Mini Obstacle Course	<p>Sample items could include:</p> <ul style="list-style-type: none"> • Benches. • Pylons or other similar type markers, such as chairs. • Tables. • Balls.

Fun Events

Name of Event	Equipment Required
Egg/Candy Carry	<ul style="list-style-type: none"> • Candy (or some similar object). • Spoons. • Pylons or other similar type markers, such as chairs.
Sweater Pull	<ul style="list-style-type: none"> • Very large sweater. • Pylon or other similar type markers, such as chairs.
Pantyhose Pull-on With Mittens/ Oven Mitts	<ul style="list-style-type: none"> • Pantyhose (amount to be dependent upon number of cadets participating). • Mittens or oven mitts (three to four pairs).
Boots Nailed to 2x4, Group Walks Together	<ul style="list-style-type: none"> • Pre-made pieces of wood with boots secured to it.
Three-legged Race	<ul style="list-style-type: none"> • Scarves.
Human Knot	<ul style="list-style-type: none"> • N/A.
Old Clothes Race	<p>A multitude of very large clothing to include:</p> <ul style="list-style-type: none"> • T-shirts. • Sweatshirts. • Track pants. • Shorts. • Hats. • Mitts/gloves. • Scarves.
Orange in Pantyhose Relay Race	<ul style="list-style-type: none"> • Pantyhose (numerous pairs). • Oranges (numerous)/tennis balls. • Pylon or other similar type markers, such as chairs.

STATIONS SCORE SHEETS

STATION 1 GROUP 1 SCORE:	STATION 1 GROUP 2 SCORE:	STATION 1 GROUP 3 SCORE:	STATION 1 GROUP 4 SCORE:	STATION 1 GROUP 5 SCORE:
STATION 1 GROUP 6 SCORE:	STATION 1 GROUP 7 SCORE:	STATION 1 GROUP 8 SCORE:	STATION 1 GROUP 9 SCORE:	STATION 1 GROUP 10 SCORE:
STATION 2 GROUP 1 SCORE:	STATION 2 GROUP 2 SCORE:	STATION 2 GROUP 3 SCORE:	STATION 2 GROUP 4 SCORE:	STATION 2 GROUP 5 SCORE:
STATION 2 GROUP 6 SCORE:	STATION 2 GROUP 7 SCORE:	STATION 2 GROUP 8 SCORE:	STATION 2 GROUP 9 SCORE:	STATION 2 GROUP 10 SCORE:

STATION 3 GROUP 1 SCORE:	STATION 3 GROUP 2 SCORE:	STATION 3 GROUP 3 SCORE:	STATION 3 GROUP 4 SCORE:	STATION 3 GROUP 5 SCORE:
STATION 3 GROUP 6 SCORE:	STATION 3 GROUP 7 SCORE:	STATION 3 GROUP 8 SCORE:	STATION 3 GROUP 9 SCORE:	STATION 3 GROUP 10 SCORE:
STATION 4 GROUP 1 SCORE:	STATION 4 GROUP 2 SCORE:	STATION 4 GROUP 3 SCORE:	STATION 4 GROUP 4 SCORE:	STATION 4 GROUP 5 SCORE:
STATION 4 GROUP 6 SCORE:	STATION 4 GROUP 7 SCORE:	STATION 4 GROUP 8 SCORE:	STATION 4 GROUP 9 SCORE:	STATION 4 GROUP 10 SCORE:

STATION 5 GROUP 1 SCORE:	STATION 5 GROUP 2 SCORE:	STATION 5 GROUP 3 SCORE:	STATION 5 GROUP 4 SCORE:	STATION 5 GROUP 5 SCORE:
STATION 5 GROUP 6 SCORE:	STATION 5 GROUP 7 SCORE:	STATION 5 GROUP 8 SCORE:	STATION 5 GROUP 9 SCORE:	STATION 5 GROUP 10 SCORE:
STATION 6 GROUP 1 SCORE:	STATION 6 GROUP 2 SCORE:	STATION 6 GROUP 3 SCORE:	STATION 6 GROUP 4 SCORE:	STATION 6 GROUP 5 SCORE:
STATION 6 GROUP 6 SCORE:	STATION 6 GROUP 7 SCORE:	STATION 6 GROUP 8 SCORE:	STATION 6 GROUP 9 SCORE:	STATION 6 GROUP 10 SCORE:

STATION 7 GROUP 1 SCORE:	STATION 7 GROUP 2 SCORE:	STATION 7 GROUP 3 SCORE:	STATION 7 GROUP 4 SCORE:	STATION 7 GROUP 5 SCORE:
STATION 7 GROUP 6 SCORE:	STATION 7 GROUP 7 SCORE:	STATION 7 GROUP 8 SCORE:	STATION 7 GROUP 9 SCORE:	STATION 7 GROUP 10 SCORE:
STATION 8 GROUP 1 SCORE:	STATION 8 GROUP 2 SCORE:	STATION 8 GROUP 3 SCORE:	STATION 8 GROUP 4 SCORE:	STATION 8 GROUP 5 SCORE:
STATION 8 GROUP 6 SCORE:	STATION 8 GROUP 7 SCORE:	STATION 8 GROUP 8 SCORE:	STATION 8 GROUP 9 SCORE:	STATION 8 GROUP 10 SCORE:

STATION 9 GROUP 1 SCORE:	STATION 9 GROUP 2 SCORE:	STATION 9 GROUP 3 SCORE:	STATION 9 GROUP 4 SCORE:	STATION 9 GROUP 5 SCORE:
STATION 9 GROUP 6 SCORE:	STATION 9 GROUP 7 SCORE:	STATION 9 GROUP 8 SCORE:	STATION 9 GROUP 9 SCORE:	STATION 9 GROUP 10 SCORE:
STATION 10 GROUP 1 SCORE:	STATION 10 GROUP 2 SCORE:	STATION 10 GROUP 3 SCORE:	STATION 10 GROUP 4 SCORE:	STATION 10 GROUP 5 SCORE:
STATION 10 GROUP 6 SCORE:	STATION 10 GROUP 7 SCORE:	STATION 10 GROUP 8 SCORE:	STATION 10 GROUP 9 SCORE:	STATION 10 GROUP 10 SCORE:

THIS PAGE INTENTIONALLY LEFT BLANK

SPORTS TABLOID MASTER SCORE SHEET

	Group 1	Group 2	Group 3	Group 4	Group 5	Group 6	Group 7	Group 8	Group 9	Group 10
Station 1										
Station 2										
Station 3										
Station 4										
Station 5										
Station 6										
Station 7										
Station 8										
Station 9										
Station 10										
TOTAL										

THIS PAGE INTENTIONALLY LEFT BLANK

TYPES OF TOURNAMENTS

Ladder Tournament

- The ladder tournament is based on a draw.
- A ladder with spaces on it will record the progress of the tournament. The names of competitors are printed and placed on the ladder in the order of the draw.
- The following rules must be applied as the tournament progresses:
 - Each contestant is permitted to challenge the player above them, up to a maximum of three above.
 - If the challenger wins, or if the challenge is not accepted within a given amount of time, the tags are interchanged, with the challenger moving up the ladder.
 - Organizers may have to modify rules slightly to suit the nature of the competition; however, all parties should be aware of the modifications prior to commencement of the tournament.
- If the number of entries is too large to accommodate on one ladder, more than one can be used, with competitors moving from the junior ladder up. In this situation, the rules are as follows:
 - A player who wishes to enter the competition must challenge the player at the bottom of the lowest ladder.
 - Upon reaching the top of the ladder, the competitor can then challenge the bottom player of the next ladder.

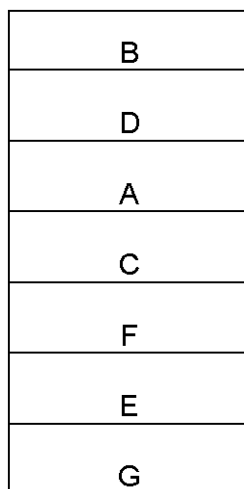

Figure 5H-1 Ladder Tournament

Pyramid Tournament

- The pyramid tournament is based on a draw.
- The board is set up in the form of a pyramid, with one player at the top, two in the next row, and so forth. The names of competitors are printed and placed on the pyramid in the order of the draw.
- Each competitor or team is able to challenge anyone in the row above them.
- If a challenger wins, they switch positions with the competitor they challenged.
- If the challenger wins, or if the challenge is not accepted within the given timeframe, the tags are interchanged.
- Organizers may have to modify rules slightly to suit the nature of the competition, but all parties should be aware of all modifications prior to commencement of the tournament.

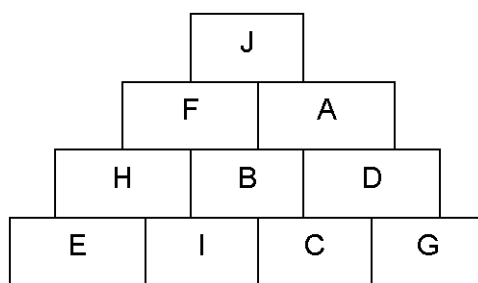

Figure 5H-2 Pyramid Tournament

Single Round-Robin Tournament

- Every competitor, either team or individual, will play each other once.
- The maximum amount of entries should be eight. Otherwise some form of preliminary elimination round may need to be held to bring the number of entries down to eight.
- The number of games required to be completed is calculated by multiplying the number of entries by the same number minus one, then divided by two.

Example: Number of Teams = 8

$$\text{Number of Games} = (8 \times [8 - 1]) \div 2 = 28 \text{ games}$$

- Methods of Draw
 - To arrange the rounds and the games scheduled for an even number of entries, keep the first entry constant and rotate the rest in the following manner:

Round 1	Round 2	Round 3	Round 4	Round 5
1-6	1-5	1-4	1-3	1-2
2-5	6-4	5-3	4-2	3-6
3-4	2-3	6-2	5-6	4-5

Note: The number of rounds for an even number of entries equals the number of entries minus one. As per the example, there are five rounds for six teams.

- To arrange the rounds and games schedule for an uneven number of entries, give each contestant (team or individual) a bye in one round of play, and rotate the remaining entries, in the following manner:

Round 1	Round 2	Round 3	Round 4	Round 5
5-bye	4-bye	3-bye	2-bye	1-bye
1-4	1-3	1-2	1-5	3-5
2-3	5-2	4-5	3-4	2-4

Note: The number of rounds for an uneven number of entries is the same as the number of entries.

Single Elimination Tournament

- This type of tournament is the quickest way of determining a winner.
- Important terminology to understand include the following:
 - **Round (Series).** The part of the competition during which each participant or team meets one of the opponents according to a draw.
 - **Bye.** When a participant or team moves into the next round of the competition without participating in the previous round.
 - **Walk-over (or Win by Default).** When a participant wins without competing because their opponent failed to appear for the competition; no participant in a competition should have a bye immediately followed by a walk-over or two consecutive walk-overs.
 - **Bagnall-wild Tournament.** This is used in connection with a single elimination in order to decide the second and third place winners. The two losers in the semi-finals play off, and the winner then meets the loser of the finals. This winner is then given the second place and the loser is given third place.
- The single elimination tournament is based on the following principles:
 - Each entrant is eliminated after the first defeat.
 - The number of entries is not limited.
 - When the number of entries is not a power of two, it is necessary to have a number of byes. All byes must be given in the first round so that the number of entries remaining in the subsequent rounds are always a power of two.
 - In computing the number of byes, the number of entries is subtracted from the next highest power of two, for example:
 - 11 entries = 5 byes ($16 - 11 = 5$)
 - 6 entries = 2 byes ($8 - 6 = 2$)
 - 21 entries = 11 byes ($32 - 21 = 11$)
 - Competitors drawing a bye in the first round shall be the first to compete in the second round.
 - No competitor may receive a bye in the first round and a walk-over in the second round or two consecutive walk-overs. Should such a situation arise, a fresh draw shall be made of the opponents for those competitors who have already received a bye or walk-over in the preceding round.
 - The number of games required to complete the schedule equals the number of entries minus one.
 - The following elements should be adhered to when making the draw:
 - Draw up the skeleton plan.
 - Draw the names out of the hat and place them in the order of the draw.
 - If seeded players are competing, first place them in each section of the draw so that they may be expected to reach the semi or quarter finals without meeting another seeded player before drawing the remaining positions out of the hat. Seeded players are known to the tournaments and are placed in a position where they are expected to do well.

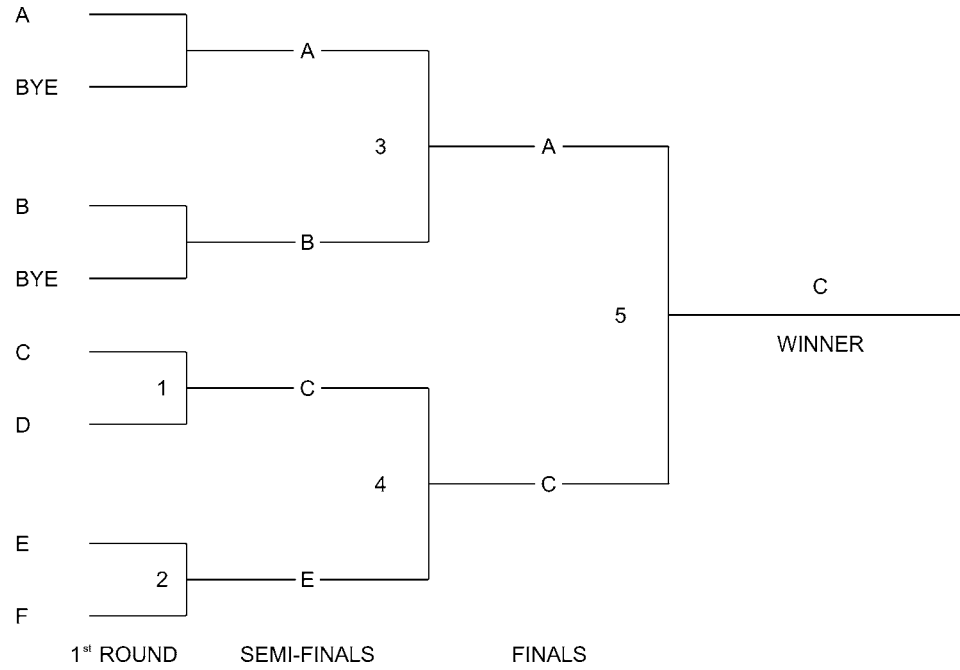

Figure 5H-3 Single Elimination Tournament

Double Elimination Tournament

- This type of tournament is longer than the single elimination tournament, as entrants are eliminated only after their second defeat.
- This type of tournament is organized in the same manner as a single elimination tournament with the added variance of a B table being created. As a team loses a game it becomes entered into the corresponding slot in the B table. Teams losing in the first round, which is where all members start, become placed in the first round of the B table. Players losing in the second round of the A table get placed in the second round of the B table.
- Byes are allotted in the first round and odd man entries into the B table move into the next round of the B table.
- Doubling the number of entrants and subtracting one determines the maximum number of games for a double elimination tournament

(Team number x 2) - 1 = maximum as per the example below.

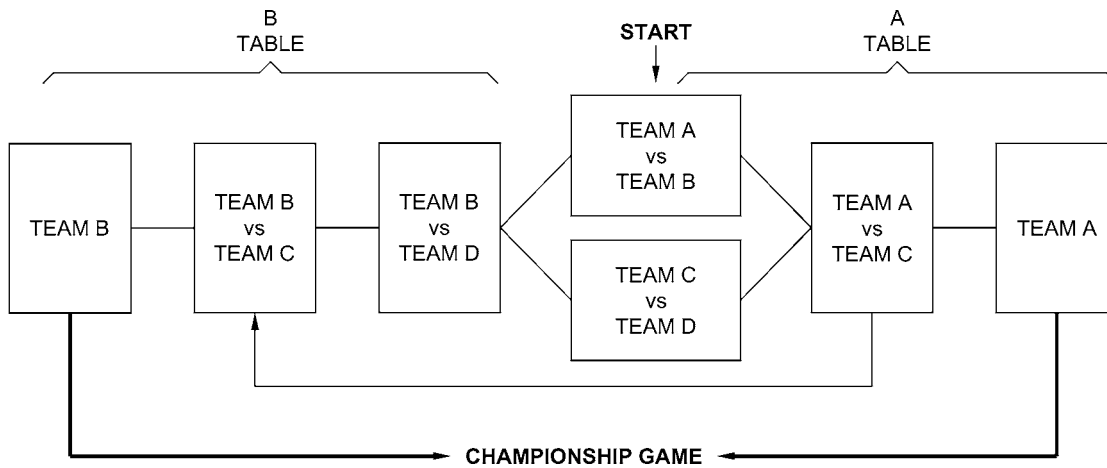

Figure 5H-4 Double Elimination Tournament Example

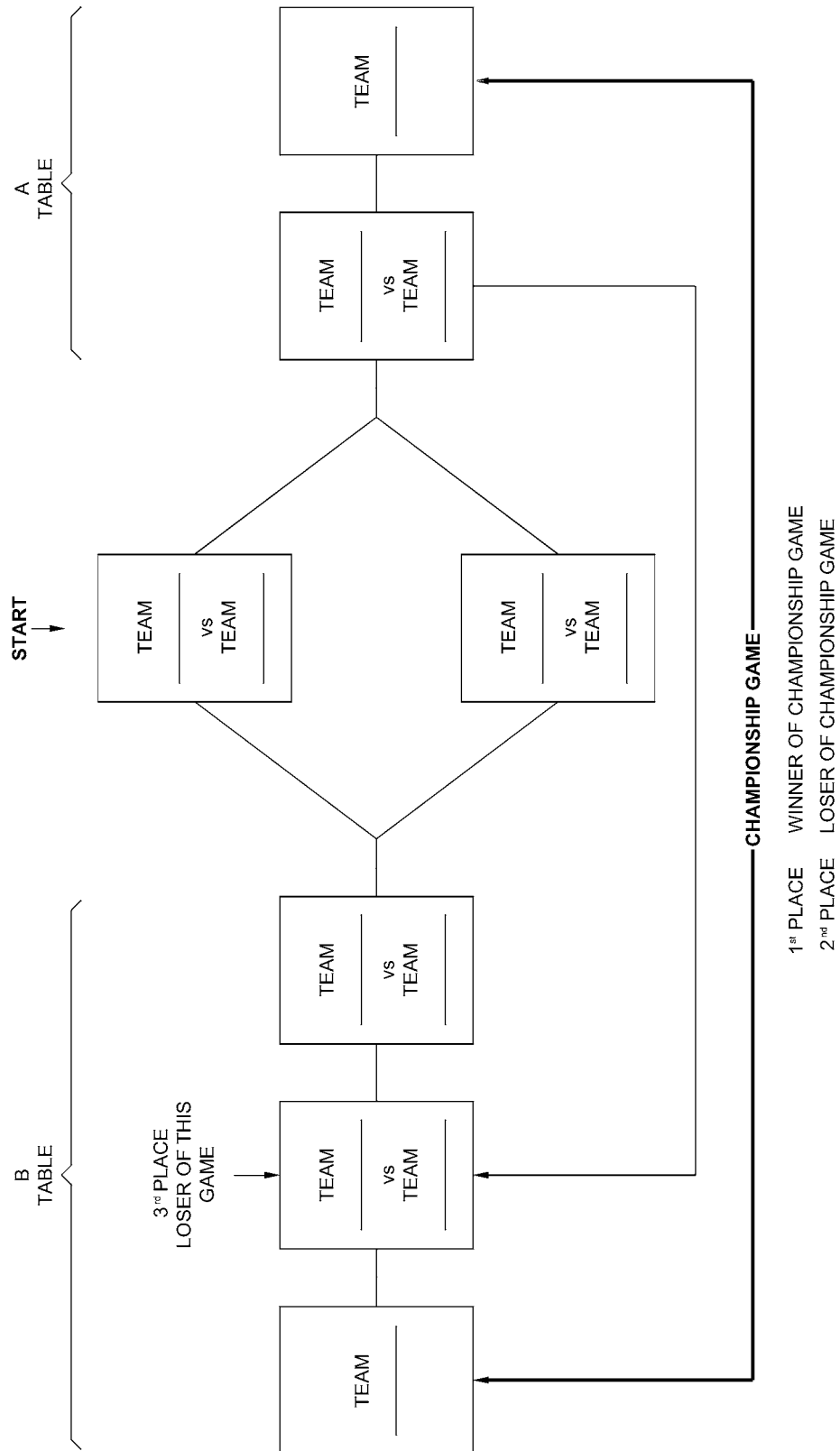

Figure 5H-5 Double Elimination Tournament

THIS PAGE INTENTIONALLY LEFT BLANK

CHAPTER 6
PO 106 – FIRE THE CADET AIR RIFLE



COMMON TRAINING INSTRUCTIONAL GUIDE



SECTION 1

EO M106.01 – IDENTIFY THE PARTS AND THE CHARACTERISTICS OF THE DAISY 853C AIR RIFLE

Total Time:

30 min

INTRODUCTION

PRE-LESSON INSTRUCTIONS

A complete list of resources needed for the instruction of this EO is located at Chapter 2 of the QSP. Specific uses for said stores are identified throughout the Instructional Guide, within the teaching point for which they are required.

Prior to instructing this lesson the instructor shall:

- review the lesson content, and become familiar with the material;
- carry out a safety precaution check on all rifles to be used during this lesson; and
- state to cadets that the rifles have been inspected and are safe to handle.

PRE-LESSON ASSIGNMENT

N/A.

APPROACH

This lesson will be presented using the interactive lecture method. The interactive lecture method was chosen as it best allows the instructor to make a semi-formal presentation of the material allowing the cadets to participate by asking or responding to questions, commenting on the material, or participating in short activities. This method appeals to auditory learners, with the potential for active participation in activities that appeal to tactile/ kinaesthetic learners.

REVIEW

N/A.

OBJECTIVES

By the end of this lesson the cadet shall be expected to identify the parts, and list the characteristics of the cadet air rifle.

IMPORTANCE

Cadets must have a basic knowledge of the cadet air rifle in order to understand how the rifle works and to safely follow directions given on the range.

Teaching Point 1**Identify the Parts of the Daisy 853C Air Rifle**

Time: 13 min

Method: Interactive Lecture

PARTS

- Depending on the number of rifles available, distribute them with an optimum ratio of one rifle for every two cadets.
- When possible, have a second instructor in the room to assist.
- **For safety purposes, maintain strict class control at all times.**

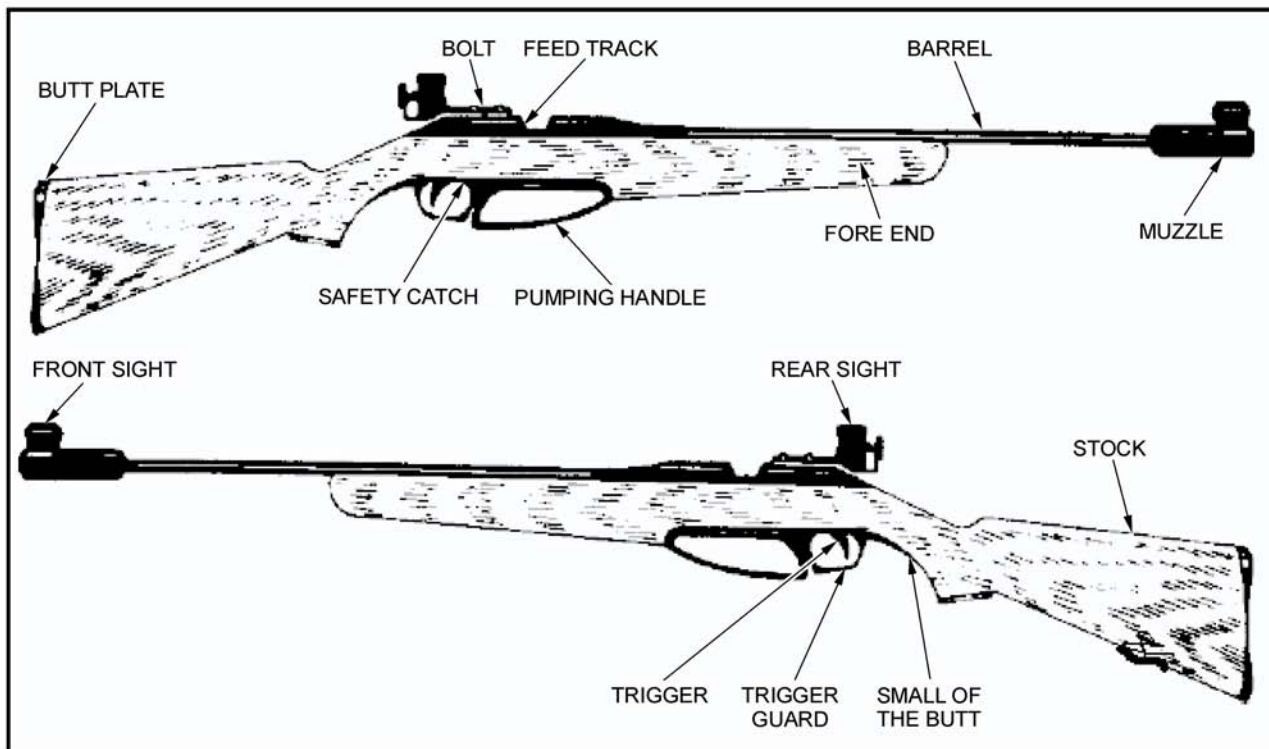

A-CR-CCP-177/PT-001

Figure 6-1-1 Parts of the Cadet Air Rifle

Butt Plate (End of the Butt). It is the part of the rifle directly in contact with the marksman's shoulder. When fitted properly, the butt plate aids in achieving a snug fit, and a consistent placement of the rifle into the shoulder. The addition of butt spacers allows for this adjustment in length.

Spacers. Plastic inserts that can be added or removed from the butt plate to vary its length. To add or take away butt spacers, use a Phillips screwdriver to loosen the butt plate and slide in/out the amount of spacers desired.

Small of the Butt (Pistol Grip). Curved area directly behind the trigger guard where the hand controlling the trigger grips the rifle.

Stock. Complete wooden portion of the rifle (from the butt plate end forward).

Fore End (of the Stock). Wooden portion of the stock from the trigger guard forward, in which the barrel and the rifle mechanism are encased.

Sling. It is a web sling made of nylon. Links the rifle to the marksman's arm to support most of the weight of the rifle. One end attaches to the sling bracket and the other to the upper arm.

Sling Bracket (Hand Stop). Adjustable metal clasp attached to the fore stock used to affix the sling to the rifle. It also acts as a hand stop, used to rest the left hand to prevent it from moving.

Trigger. Movable device that releases a spring and releases the rifle mechanism. This rifle has a single stage trigger that cannot be adjusted for weight.

Trigger Guard. Metal band that surrounds and protects the trigger.

Safety Catch. This is a mechanism that, once engaged, prevents the rifle from firing by locking the trigger in place. It is a cross bolt type device located on the trigger guard. The black side indicates that the rifle is unable to fire; the red side indicates the rifle is ready to fire. It should be ON (no red) at all times, unless firing.

Bolt. Metal lever used for opening or closing the rifle mechanism. It must be in the closed position in order to fire. For maximum safety when the rifle is uncased and not firing, the bolt should be kept open.

Pump Handle. Metal lever used to compress the air required to fire the pellet. Whenever the rifle is in a "safe rifle status", the pump lever should be left partially open.

Front Sight. Global front sight that uses aperture inserts.

Rear Sight. Micrometer sight adjustable for windage and elevation. It is easily attached to a metal rail located above the action. This rail allows for adjustment of the sight forward or backward, in order to maintain proper eye relief. The sight is attached using a small flat-blade screwdriver.

Muzzle. Front end of the barrel equipped with attachable barrel weight.

Barrel With Barrel Weight. Steel tube through which the pellet travels, extending from the muzzle to the chamber. The barrel weight ensures that the rifle's weight is evenly distributed and that the rifle's balance is maintained.

Bore. Interior of the barrel has spiral grooves cut into it. The lands are the ridges of metal between the grooves. Together, the grooves and lands are called rifling.

Feed Track. Delicate area where the pellet is inserted manually onto a single pellet adapter, or with a five-shot clip.

Single Shot Adapter. Plastic clip that aids in placing a pellet in the chamber.

Five-shot Clip. Plastic clip that holds a maximum of five pellets and used to place the pellets in the chamber.

Chamber. Location where the pellet is held before firing.

CONFIRMATION OF TEACHING POINT 1

The instructor shall ensure that the cadet can identify the parts of the cadet air rifle by physically pointing to the parts, and having the cadets properly name the part.

Teaching Point 2**Identify the Characteristics of the Daisy 853C Air Rifle**

Time: 12 min

Method: Interactive Lecture

CHARACTERISTICS

Identify the main characteristics of the cadet air rifle. Focus on these points during the confirmation section of this teaching point.

The characteristics of the Daisy 853C air rifle are:

- **Action.** Single pump pneumatic, straight pull-bolt.
- **Total Length.** 97.8 cm.
- **Total Weight.** 2.5 kg.
- **Calibre.** 0.177 calibre (4.5 mm).
- **Front Sight.** Global type with interchangeable aperture inserts.
- **Rear Sight.** Fully adjustable peep rear sight with micrometer click adjustment.
- **Muzzle Velocity.** 150.8 metres per second.
- **Loading.** Single or auto indexing five-pellet clip.
- **Stock.** Full-length, sporter-styled hardwood with adjustable length.
- **Safety.** Manual cross-bolt trigger block with red indicator.



These characteristics are “Nice to Know” and should be taught only if time permits.

- **Barrel.** Lothar Walther rifled high-grade steel barrel with weight: crowned 12 lands and grooves, right hand twist. Precision bore sized for match pellets. Approximate length 53.1 cm.
- **Maximum Range.** 235.4 metres.
- **Sling.** Adjustable competition web.
- **Trigger Weight.** Minimum 3.5 lb.
- **Chamber.** Open loading and made of steel.
- **Pumping Force.** 20 lbf.



With a muzzle velocity of 150.8 metres per second, the cadet air rifle is not a “firearm” under the current federal firearms legislation, but it is treated as one under the definition used by the Military Police.

CONFIRMATION OF TEACHING POINT 2

QUESTIONS

- Q1. The cadet air rifle has what type of action?
 Q2. What is the calibre of the cadet air rifle?
 Q3. The cadet air rifle uses what type of safety?

ANTICIPATED ANSWERS

- A1. Single pump pneumatic, straight pull-bolt.
 A2. 0.177 calibre (4.5 mm).
 A3. Manual cross-bolt trigger block with red indicator.

END OF LESSON CONFIRMATION

This EO may be confirmed with the handout found at Annex A. Allow cadets a few minutes to complete the annex, then have cadets switch sheets for correcting.



Correctly labelled diagram is located at page 6A-2.

CONCLUSION

HOMework/READING/PRACTICE

Cadets are to take home the corrected handout to study the parts of the cadet air rifle.

METHOD OF EVALUATION

The instructor will confirm cadets' ability to identify the parts and characteristics of the cadet air rifle by asking questions during the end of lesson confirmation, and with the handout found at Annex A.

CLOSING STATEMENT

Knowing the parts and characteristics of the cadet air rifle is important in understanding how the rifle works. This allows the cadet to be able to follow directions given on the range, and properly perform a handling test whenever an air rifle is to be used.

INSTRUCTOR NOTES/REMARKS

Emphasis must be placed on the safety aspect of this lesson.

REFERENCES

- A0-027 A-CR-CCP-177/PT-001 D Cdts 3. (2001). *Canadian Cadet Movement: Cadet Marksmanship Programme Reference Manual*. Ottawa, ON: Department of National Defence.

THIS PAGE INTENTIONALLY LEFT BLANK



COMMON TRAINING INSTRUCTIONAL GUIDE



SECTION 2

EO M106.02 – CARRY OUT SAFETY PRECAUTIONS ON THE CADET AIR RIFLE

Total Time:

30 min

INTRODUCTION

PRE-LESSON INSTRUCTIONS

A complete list of resources needed for the instruction of this EO is located at Chapter 2 of the QSP. Specific uses for said stores are identified throughout the Instructional Guide, within the teaching point for which they are required.

Prior to instructing this lesson the instructor shall:

- review the lesson content, and become familiar with the material; and
- carry out a safety precaution check on all rifles to be used during this lesson. State to cadets that the rifles have been inspected and are safe to handle.

PRE-LESSON ASSIGNMENT

N/A.

APPROACH

This lesson will be presented using the demonstration and performance method for TP1 and TP2 and the interactive lecture method for TP3. The demonstration-performance method was chosen to allow cadets to participate in supervised exploration of practical instructional material. This method provides the instructor the opportunity to introduce the subject matter, demonstrate and explain procedures, and supervise the cadets while they imitate the skill. This method appeals to all learning styles. The interactive lecture method was chosen as it best allows the instructor to make a semi-formal presentation of the material allowing the cadets to participate by asking or responding to questions, commenting on the material, or participating in short activities. This method appeals to auditory learners, with the potential for active participation in activities that appeal to tactile/kinaesthetic learners.

REVIEW

The pertinent review for this lesson from, EO M106.01 (Section 1), will include:

- Having the cadets identify the characteristics of the Daisy 853C, to include:
 - **Action.** Single pump pneumatic, straight pull-bolt.
 - **Calibre.** 0.177 calibre (4.5 mm).
 - **Safety.** Manual cross-bolt trigger block with red indicator.

- **Loading.** Single or auto indexing five-shot clip.
- **Muzzle Velocity.** 150.8 metres per second.
- Having the cadets identify parts of the Daisy 853C by physically pointing to them and naming them, to include:
 - butt plate;
 - small of the butt (pistol grip);
 - sling bracket (hand stop);
 - trigger;
 - trigger guard;
 - safety catch;
 - bolt;
 - pump lever;
 - muzzle;
 - barrel with barrel weight; and
 - feed track.

OBJECTIVES

By the end of this lesson the cadet shall be expected to carry out individual safety precautions on the cadet air rifle.

IMPORTANCE

Safety precautions are essential to ensure everyone's safety on the range. Every time a cadet picks up a rifle or steps on a range, they must have safety in mind and check to ensure the rifle is safe (an individual safety precaution check when receiving, handing over, or returning to a rifle). Even when a rifle is presumably safe, it is to be checked again.

Teaching Point 1

Explain and Demonstrate How To Carry Out Individual Safety Precautions for the Cadet Air Rifle

Time: 10 min

Method: Demonstration and Performance

REMOVING A RIFLE FROM THE CASE

The rifle case should be clearly marked on the outside with an arrow, indicating in what direction the rifle inside is pointing. This will ensure that, when the case is opened, the rifle is pointing in a safe direction. The following steps must be followed when removing a rifle from its case:

1. Place the rifle case on a flat surface and ensure the arrow is pointing in a safe direction.
2. Open the case.
3. Cock the action (leave the bolt to the rear).

4. Confirm that the safety catch is ON.
5. Confirm that the pumping lever is partially open.
6. Slide the safety rod in the barrel towards the bolt until it can be seen in the feed track.
7. Remove the rifle from the case.
8. Remove the safety rod when you are on the firing line.

SAFETY CATCH AND SECURITY MEASURES

The safety catch is a mechanism that, once engaged, prevents a rifle from firing by locking its trigger into place. It is located just in front of the trigger, on the trigger guard. To engage the safety catch (ON) it must be pushed towards the right **so no red can be seen**. To fire, the safety catch must be pushed towards the left in the OFF position and a red mark must be seen on it. For maximum security, it is recommended that the safety catch be kept engaged until the rifle is ready for firing.

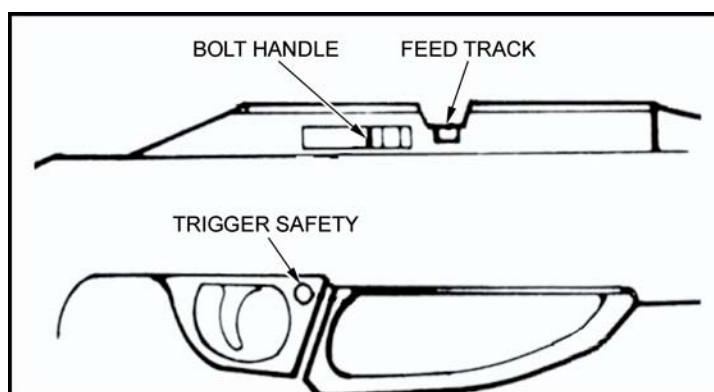

Daisy 853C Operational Manual

Figure 6-2-1 Safety Catch

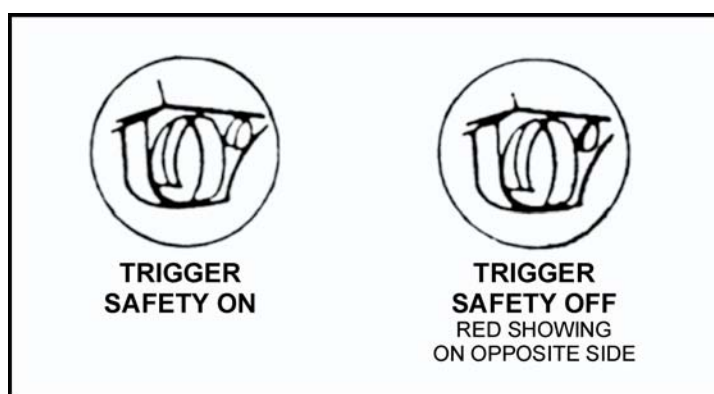

Daisy 853C Operational Manual

Figure 6-2-2 Safety Catch Detail View

SAFETY ROD

To ensure that air rifles are not removed from the firing point or stored with a pellet in the chamber or barrel, a safety rod is to be inserted in the barrel from the muzzle end. It consists of two sections of doweling joined

together in a “T” shape, and may be made of varying materials. Dimensions are detailed in Figure 6-2-3. The tip of the safety rod is to be coloured red so that it is visible in the feed track with the bolt fully to the rear.

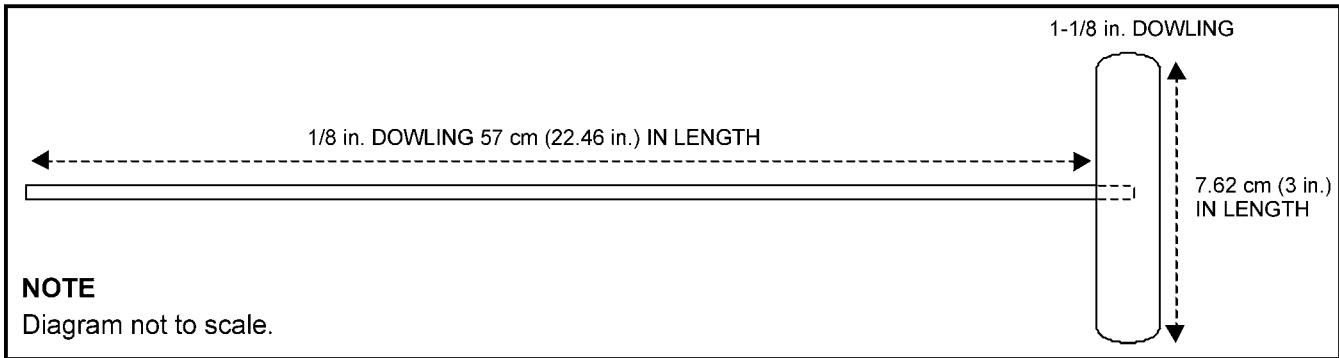

Cadet Marksmanship Program Reference Manual

Figure 6-2-3 Safety Rod

SAFE RIFLE STATUS



The instructor shall demonstrate and explain points 1, 2 and 3 of the safe rifle status checks using full demonstrations and explanations prior to each new skill, followed by a chance for the cadets to imitate the skill under supervision.

When not being handled on the range or in a training environment, the air rifle must be in a safe status. The following options denote various states of “safe rifle status”:

1. **In the rifle case:**
 - a. The safety catch is ON.
 - b. The bolt is forward.
 - c. The action is not cocked.
 - d. The safety rod is in the case but not in the barrel.
 - e. The pump lever is partially open (5 to 8 cm).
2. **On the firing line:**
 - a. The safety catch is ON.
 - b. The bolt is to the rear.
 - c. The pump lever is partially open.
3. **Off the firing line:**
 - a. The safety catch is on.
 - b. The bolt is to the rear.
 - c. The safety rod is in the barrel (visible in the feed track).
 - d. The pump lever is partially open.

CONFIRMATION OF TEACHING POINT 1

Have the cadets, under supervision, perform the steps for “Safe Rifle Status” for:

- a. on the firing line; and
- b. off the firing line.

Teaching Point 2

Carry Out Individual Safety Precautions

Time: 10 min

Method: Demonstration and Performance

INDIVIDUAL SAFETY PRECAUTIONS

	<p>The instructor shall provide an EXPLANATION and DEMONSTRATION of the complete skill.</p> <p>The instructor shall also provide an EXPLANATION and DEMONSTRATION of each step required to effectively complete the skill.</p>
---	--

Upon receiving a rifle, or when the “Safe Rifle Status” is uncertain, individual safety precautions shall be done to confirm that the rifle is safe. An individual must ensure that:

1. the bolt is open fully to the rear;
2. the safety catch is in the ON position;
3. the pump lever is left partially open; and
4. a safety rod is placed in the barrel.

	<p>Cadets will IMITATE the demonstration provided by the instructor for each step within the skill. The instructor(s) will SUPERVISE the cadets during this imitation.</p>
---	--

CONFIRMATION OF TEACHING POINT 2

Have cadets carry out individual safety precautions. Cadets will also be required to perform this skill during their air rifle handling test.

Teaching Point 3

Explain and Demonstrate Safety Regulations for the Cadet Air Rifle

Time: 5 min

Method: Interactive Lecture

SAFETY REGULATIONS

Safety regulations are all common sense and are easy to apply when people understand that they are necessary to help prevent accidents with the air rifle. Regulations include:

1. treating the air rifle as if it is loaded;

2. never pointing the air rifle at anyone;
3. holding the rifle vertically when moving to and from the firing point;
4. leaving fingers off the trigger until ready to fire;
5. wearing safety glasses/goggles; and
6. employing hygiene on the range by washing hands after every practice.



The Canadian Firearms Centre safety training teaches that the vital four “**ACTS**” of firearm safety. The acronym “**ACTS**” stands for:

- **A**ssume every firearm is loaded.
- **C**ontrol the muzzle direction at all times.
- **T**rigger finger must be kept off the trigger and out of the trigger guard.
- **S**ee that the firearm is unloaded – prove it safe.

CONFIRMATION OF TEACHING POINT 3

QUESTIONS

- Q1. Why do we follow safety regulations?
- Q2. What are some common sense safety regulations?
- Q3. What does the acronym “ACTS” stand for?

ANTICIPATED ANSWERS

- A1. To help prevent accidents with the air rifle.
- A2. Any from list taught:
 - a. Treating the air rifle as if it is loaded.
 - b. Never point the air rifle at anyone.
 - c. Holding the rifle vertically when moving to and from the firing point.
 - d. Leaving fingers off the trigger until ready to fire.
 - e. Wearing safety glasses/goggles.
 - f. Employing hygiene on the range by washing hands after every practice.
- A3. **ACTS** stands for; **A**ssume every firearm is loaded, **C**ontrol the muzzle direction at all times, **T**rigger finger must be kept off the trigger and out of the trigger guard, **S**ee that the firearm is unloaded – prove it safe.

END OF LESSON CONFIRMATION

QUESTIONS

- Q1. What does the arrow on the rifle case indicate?
- Q2. How do we know if the safety catch is ON?
- Q3. What are the vital four “**ACTS**” of firearm safety?

ANTICIPATED ANSWERS

- A1. The direction of the rifle inside the case.
- A2. No red can be seen.
- A3. **ACTS** stands for; **A**ssume every firearm is loaded, **C**ontrol the muzzle direction at all times, **T**rigger finger must be kept off the trigger and out of the trigger guard, **S**ee that the firearm is unloaded – prove it safe.

CONCLUSION

HOMEWORK/READING/PRACTICE

N/A.

METHOD OF EVALUATION

The cadet will be required to perform individual safety precautions with the cadet air rifle as an aspect of the handling test.

CLOSING STATEMENT

Being able to carry out safety precautions on the cadet air rifle is essential for functioning safely on the range following directions given on the range, and successfully performing a handling test.

INSTRUCTOR NOTES/REMARKS

Emphasis must be placed on the safety aspects of this lesson.

REFERENCES

- A0-027 A-CR-CCP-177/PT-001 D Cdts 3. (2001). *Canadian Cadet Movement: Cadet Marksmanship Programme Reference Manual*. Ottawa, ON: Department of National Defence.

THIS PAGE INTENTIONALLY LEFT BLANK



COMMON TRAINING INSTRUCTIONAL GUIDE



SECTION 3

EO M106.03 – APPLY BASIC MARKSMANSHIP TECHNIQUES

Total Time:

60 min

INTRODUCTION

PRE-LESSON INSTRUCTIONS

A complete list of resources needed for the instruction of this EO is located at Chapter 2 of the QSP. Specific uses for said stores are identified throughout the Instructional Guide, within the teaching point for which they are required.

Prior to instructing this lesson the instructor shall:

- review the lesson content, and become familiar with the material; and
- prepare a mock air rifle range prior to the beginning of the lesson.

PRE-LESSON ASSIGNMENT

N/A.

APPROACH

This lesson will be presented using the demonstration and performance method. The demonstration-performance method was chosen to allow cadets to participate in supervised exploration of practical instructional material. This method provides the instructor the opportunity to introduce the subject matter, demonstrate and explain procedures, and supervise the cadets while they imitate the skill. This method appeals to all learning styles.



This lesson may be better presented using a round robin format for those squadrons with large first year groups.

REVIEW

The pertinent review for this lesson, from EO M106.02 (Section 2), will include:

QUESTIONS

- Q1. Why are the individual safety precautions performed?
- Q2. What is the purpose of the “safety catch”?

ANTICIPATED ANSWERS

- A1. To confirm a rifle is safe.
- A2. It prevents a rifle from firing by locking its trigger into place.

OBJECTIVES

By the end of this lesson the cadet shall be expected to apply basic marksmanship techniques to include:

- prone position;
- basic holding;
- basic aiming;
- loading;
- firing; and
- unloading.

Cadets will apply the knowledge gained during this lesson when they participate in any range practice.

IMPORTANCE

These techniques must all be applied in harmony. Improving one while not working on another will not produce the best results in the long run. Perfecting these techniques takes time and concentration. Cadets should remember – PRACTICE MAKES PERFECT!

Teaching Point 1

Explain and Demonstrate the Prone Position

Time: 4 min

Method: Demonstration and Performance

The first principle of marksmanship is to find a comfortable shooting position. A comfortable shooting position will enable cadets to shoot safely and with much better results. The prone position is the most stable shooting position to use.

OBJECTIVES OF A GOOD POSITION



Have cadets down get on the mat and assume the prone position. From here, the instructor is better prepared to observe the cadets imitating the skills being taught.



The instructor shall provide an EXPLANATION and DEMONSTRATION of the complete skill.

The instructor shall also provide an EXPLANATION and DEMONSTRATION of each step required to effectively complete the skill.

Obtaining a good prone position is one of the most, if not the most, important principle of marksmanship. A good prone position helps to maintain comfort and stability during the firing session. The prone position is assumed

when the shooter lies flat, directly behind the rifle, with a very slight angle between their body and the rifle, and in line with the target. The position should be:

- natural;
- without strain;
- comfortable; and
- stable, in that the:
 - body should form an angle with the line of sight;
 - spine should remain straight;
 - left leg should be parallel with the spine;
 - right foot should turn out and point to the right;
 - left foot should either be straight or point towards the right; and
 - right knee should form an angle with the left leg.

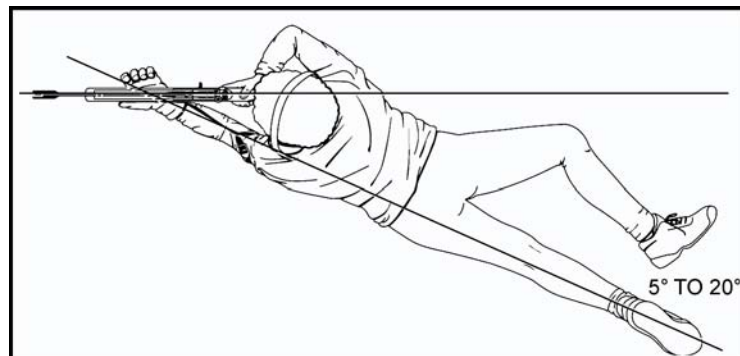

Cadet Marksmanship Program Reference Manual

Figure 6-3-1 Prone Position



Cadets will IMITATE the demonstration provided by the instructor for each step within the skill. The instructor(s) will SUPERVISE the cadets during this imitation.

CONFIRMATION OF TEACHING POINT 1



The instructor will divide the group into two, or, by the number of air rifles available.

The instructor shall have one group imitate the actions of the sequence as demonstrated, while the remainder observe. Have them trade places, and repeat.

Teaching Point 2**Explain and Demonstrate How To Hold the Cadet Air Rifle**

Time: 7 min

Method: Demonstration and Performance

HOLDING THE CADET AIR RIFLE

The instructor shall provide an EXPLANATION and DEMONSTRATION of the complete skill.

The instructor shall also provide an EXPLANATION and DEMONSTRATION of each step required to effectively complete the skill.

The prone position allows holding to be achieved with as little movement and muscular tension as possible, in that the:

- left elbow should be positioned slightly to the left of the rifle;
- left hand must rest firmly against the sling swivel, and the fingers should be relaxed and not grip the fore end;
- right hand should slightly grip the small of the butt with constant pressure;
- right thumb should be placed on the stock directly behind the rear sight or around the small of the butt;
- right elbow should rest naturally where it falls, not too close or too far from the rifle;
- the shoulders should be straight and form right angles with the spine;
- the butt plate is kept firmly in the hollow of the right shoulder. The right elbow will naturally fall in the same spot throughout the relay; and
- the head rests comfortably on the butt and remains straight.



Cadet Marksmanship Program Reference Manual

Figure 6-3-2 Prone Position (Front)



Cadet Marksmanship Program Reference Manual

Figure 6-3-3 Prone Position (Side)



Cadets will IMITATE the demonstration provided by the instructor for each step within the skill. The instructor(s) will SUPERVISE the cadets during this imitation.

CONFIRMATION OF TEACHING POINT 2



The instructor will divide the group into two, or, by the number of air rifles available. The instructor shall have one group imitate the actions of the sequence as demonstrated, while the remainder observe, and then have them trade places, and repeat.

Teaching Point 3
Explain and Demonstrate How To Aim the Cadet Air Rifle

Time: 4 min

Method: Demonstration and Performance

AIMING THE CADET AIR RIFLE

Cadets must constantly strive to maintain proper sight alignment, while obtaining a sight picture. It is the most critical element of the aiming process.

The **aiming process** consists of:

- adopting a comfortable position; and
- ensuring proper body alignment with the target.

Sight Alignment. It is the alignment of the eye, the rear sight, and the front sight. When cadets bring their eye 5 to 15 cm from the rear sight, they will find that the small hole is large enough to look through and see all of the front sight. Proper sight alignment is a matter of centering the front sight tube in the rear sight. The tube will not quite fill the rear sight and cadets will be able to see light around the outside of the tube; we call this a “line of white”.

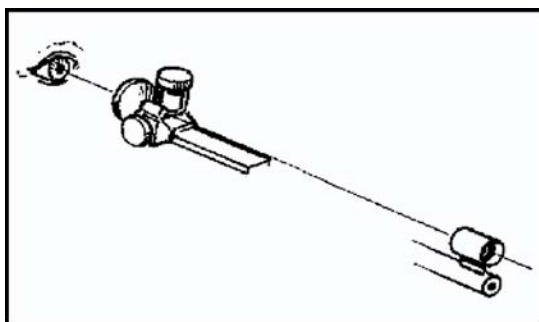

Cadet Marksmanship Program Reference Manual

Figure 6-3-4 Sight Alignment

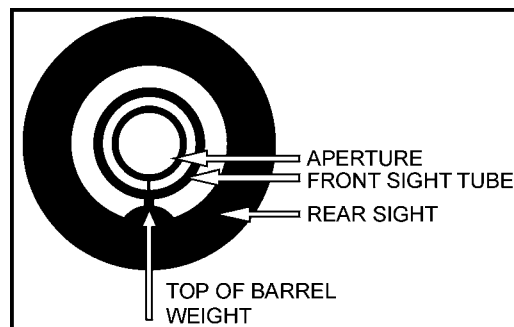

Cadet Marksmanship Program Reference Manual

Figure 6-3-5 Line of White

Sight Picture. To obtain a proper sight picture, a bull's-eye is simply added to the innermost ring. The goal during the aiming process is to maintain proper sight alignment while keeping the bull centered in the front sight.

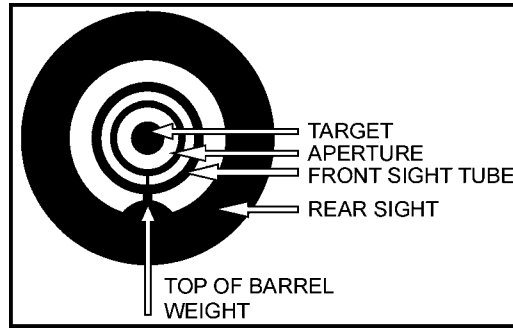

Cadet Marksmanship Program Reference Manual

Figure 6-3-6 Sight Picture

CONFIRMATION OF TEACHING POINT 3

QUESTIONS

- Q1. What are the two critical elements of the aiming process?
- Q2. Sight alignment consists of what three things?
- Q3. What is added to the innermost ring to obtain a proper sight picture?

ANTICIPATED ANSWERS

- A1. Adopting a comfortable position, and ensuring proper body alignment with the target.
- A2. The eye, the rear sight, and the front sight.
- A3. A bull's-eye.



The cadets' aiming abilities will be further assessed during future range practices. The instructor(s) will observe cadets during practices, and assess targets to confirm the skill of aiming.

Teaching Point 4

Explain and Demonstrate How To Load and Unload the Cadet Air Rifle

Time: 14 min

Method: Demonstration and Performance

LOADING THE AIR RIFLE



The instructor shall provide an EXPLANATION and DEMONSTRATION of the complete skill.

The instructor shall also provide an EXPLANATION and DEMONSTRATION of each step required to effectively complete the skill.

This will be conducted as a DRY FIRE EXERCISE ONLY.

Loading procedure:

1. Pick up the rifle with the left hand.
2. Ensure the safety catch is in the ON position.
3. Pump the air rifle, pausing for 3 seconds.
4. Bring the pump handle back to closed position.
5. Simulate loading a pellet, or load an auto indexing five-pellet clip into the feed track.
6. Close the bolt.



Cadets will IMITATE the demonstration provided by the instructor for each step within the skill. The instructor(s) will SUPERVISE the cadets during this imitation.



The following methods may be used when pumping the air rifle:

- **Option 1.** Grasp the pistol grip with the right hand. Grasp the pump handle with the left hand. Push downward with the left hand until the pump handle is fully extended. Wait for a few seconds. Using the left hand, bring the pump handle back to the stock of the rifle. The rifle should remain stationary during the pumping process and always point towards the targets.
- **Option 2.** Grasp the pistol grip with the right hand. Grasp the pump handle with the left hand. Place the butt of the rifle under the right arm or shoulder for support. Push downward with the left hand until the pump handle is fully extended. Wait for a few seconds. Using the left hand, bring the pump handle back to the stock of the rifle allowing the underarm and shoulder to help hold the rifle steady when closing the pump handle. Remember that the rifle must always point towards the targets.
- **Option 3 – Coach Assistance.** Point the rifle in a safe direction and request the assistance from a coach. The coach should move in and pump the rifle using both hands. This should be used as last resorts as any cadet can easily do the above two options.

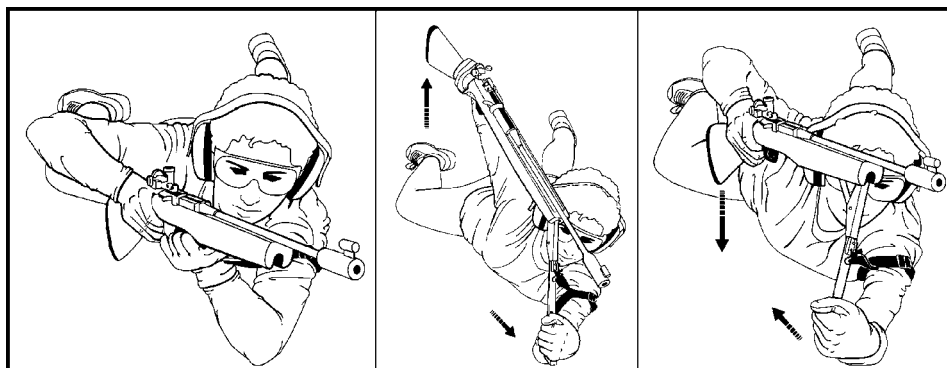

Cadet Marksmanship Program Reference Manual

Figure 6-3-7 Pumping the Air Rifle



Do not pump the rifle more than once per shot. This air rifle is designed to withstand the pressure based on a single pump stroke.



The instructor shall provide an EXPLANATION and DEMONSTRATION of the complete skill.

The instructor shall also provide an EXPLANATION and DEMONSTRATION of each step required to effectively complete the skill.

UNLOADING THE CADET AIR RIFLE

Follow the unloading sequence of the cadet air rifle, to include:

UNLOAD

1. Pick up the air rifle.
2. Remove five-pellet clip (if used).
3. Open the bolt (do not insert a pellet).
4. Pump the air rifle, pausing for 3 seconds.
5. Close the bolt (do not insert a pellet).
6. Place the safety catch in the OFF position.
7. Aim the rifle at the target.
8. Squeeze the trigger.
9. Place the safety catch in the ON position.

PREPARE FOR INSPECTION

1. Open the bolt.
2. Open the pump handle slightly.
3. Place the rifle on shoulder, muzzle pointed down range.
4. Wait to be cleared by the RSO.
5. Lay the rifle down.



Cadets will IMITATE the demonstration provided by the instructor for each step within the skill. The instructor(s) will SUPERVISE the cadets during this imitation.

CONFIRMATION OF TEACHING POINT 4



The instructor will divide the group into two, or by the number of air rifles available. The instructor shall have one group imitate the actions of the sequence as demonstrated, while the remainder observe. Have them trade places, and repeat.

Teaching Point 5

Fire the Cadet Air Rifle

Time: 22 min

Method: Demonstration and Performance

FIRING THE CADET AIR RIFLE

Follow the sequence required to fire the cadet air rifle, to include:

1. When the RSO gives the command, place safety catch in the OFF position.
2. Aim the air rifle at the target.
3. Squeeze the trigger.
4. Open the bolt, pump the rifle, reload, aim and fire.
5. Repeat the last step until firing is complete.
6. Upon completion, place the safety catch in the ON position and partially opening the pump lever.
7. Lay the air rifle down.

CONFIRMATION OF TEACHING POINT 5



The instructor will divide the group into two, or by the number of air rifles available. The instructor shall have one group imitate the actions of the sequence as demonstrated, while the remainder observe. Have them trade places, and repeat.

END OF LESSON CONFIRMATION

The instructor will divide the group into two, or by the number of air rifles available. The instructor shall have one group imitate the actions of the sequence for all teaching points as demonstrated, while the remainder observe, and then have them trade places, and repeat.

CONCLUSION

HOMework/READING/PRACTICE

N/A.

METHOD OF EVALUATION

N/A.

CLOSING STATEMENT

The first principle of marksmanship is to find a comfortable shooting position. A comfortable shooting position will enable cadets to shoot safely and with much better results. The prone position is the most stable shooting position to use.

INSTRUCTOR NOTES/REMARKS

1. Emphasis must be placed on the safety aspects of this lesson.
2. Ensure thorough confirmation by stages.

REFERENCES

A0-027 A-CR-CCP-177/PT-001 D Cdts 3. (2001). *Canadian Cadet Movement: Cadet Marksmanship Programme Reference Manual*. Ottawa, ON: Department of National Defence.



COMMON TRAINING INSTRUCTIONAL GUIDE



SECTION 4

EO M106.04 – FOLLOW RULES AND COMMANDS ON AN AIR RIFLE RANGE

Total Time:

30 min

INTRODUCTION

PRE-LESSON INSTRUCTIONS

A complete list of resources needed for the instruction of this EO is located at Chapter 2 of the QSP. Specific uses for said stores are identified throughout the Instructional Guide, within the teaching point for which they are required.

Prior to instructing this lesson the instructor shall:

- review the lesson content, and become familiar with the material; and
- prepare a mock air rifle range to be used when teaching the lesson.

PRE-LESSON ASSIGNMENT

N/A.

APPROACH

This lesson will be presented using the interactive lecture method for TP1 and the demonstration-performance method for TP2. The interactive lecture method was chosen as it best allows the instructor to make a semi-formal presentation of the material allowing the cadets to participate by asking or responding to questions, commenting on the material, or participating in short activities. This method appeals to auditory learners, with the potential for active participation in activities that appeal to tactile/kinaesthetic learners. The demonstration-performance method was chosen to allow cadets to participate in supervised exploration of practical instructional material. This method provides the instructor the opportunity to introduce the subject matter, demonstrate and explain procedures, and supervise the cadets while they imitate the skill. This method appeals to all learning styles.

REVIEW

The pertinent review for this lesson, from EO M106.03 (Section 3), will include:

QUESTIONS

- Q1. What two things do a good prone position help to maintain?
- Q2. Sight alignment consists of what three steps?
- Q3. What is added to the innermost ring to obtain a proper sight picture?

ANTICIPATED ANSWERS

- A1. Comfort and stability.
- A2. The eye, the rear sight, and the front sight.
- A3. A bull's-eye.

OBJECTIVES

By the end of this lesson the cadet shall be expected to handle rifles safely and properly execute range commands.

IMPORTANCE

Firearms safety is the number one priority on and off the range so everyone must do their part to prevent accidents. In marksmanship, the majority of incidents are caused by ignorance of proper rifle operating procedures or by mishandling.

Teaching Point 1

Explain Rules Cadets Must Follow on the Range

Time: 10 min

Method: Interactive Lecture

RULES CADETS MUST FOLLOW ON THE RANGE



The instructor will read Local Range Standing Orders at the beginning of this period.

Range Standing Orders are locally produced for each range. They detail rules to be followed on that range. General rules observed on all ranges include:

1. Rifles will be proved safe when picked up, handed to or received from another person.
2. Rifles are never pointed at any person.
3. Safety rods shall be inserted into the barrels of rifles when not in use on the range.
4. Horseplay is forbidden on the range.
5. Rifles, whether loaded or not, will always be pointed down range.
6. Eating is not permitted on or near the range or around the pellets.
7. All personnel shall read or be briefed on the contents of the Range Standing Orders.
8. The RSO's directions and orders are to be obeyed at all times.

CONFIRMATION OF TEACHING POINT 1

QUESTIONS

- Q1. When should a rifle be proved safe?

- Q2. When can rifles be pointed at other people?
 Q3. When should the directions and orders of the RSO be followed?

ANTICIPATED ANSWERS

- A1. When picked up, handed to or received from another person.
 A2. Rifles are never pointed at any person.
 A3. The RSO's directions and orders are to be obeyed at all times.

Teaching Point 2

Explain Range Commands

Time: 15 min

Method: Demonstration and Performance



The instructor shall provide an EXPLANATION and DEMONSTRATION of each command and the associated action to be taken.

All loading/firing is to be simulated. No pellets are to be fired.

RANGE COMMANDS CADETS MUST FOLLOW

Command	Action To Be Taken
1. Cover off your firing point.	1. Move to a position behind your assigned firing point.
2. Place your equipment down and stand back.	2. As directed.
3. Adopt the prone position.	3. Lay down in prone position IAW EO M106.03 (Section 3).
4. "G.R.I.T." in that GRIT is the acronym for: a. Group (relay) b. Range c. Indication d. Type	4. Listen for direction on type of shooting to be carried out.
5. Relay load, commence firing.	5. Load IAW EO M106.03 (Section 3), and fire.
6. Relay, cease fire.	6. Stop, engage the safety catch of the air rifle, and wait for directions.
7. Relay, resume fire.	7. As directed.
8. Relay, unload.	8. Unload IAW EO M106.03 (Section 3).
9. Relay, prepare for inspection.	9. Prepare for inspection IAW EO M106.03 (Section 3).
10. Relay, stand up.	10. As directed.

Command	Action To Be Taken
11. Change targets; and change relay.	11. Move forward under direction of RSO, retrieve target and replace with new one, move back off of range.



Cadets will IMITATE the demonstration provided by the instructor for each step within the process. The instructor(s) will SUPERVISE the cadets during this imitation.



The information in this teaching point is amplified in Annex B, and should be reviewed prior to any cadet participating in a shooting practice.

CONFIRMATION OF TEACHING POINT 2

Confirmation of this teaching point shall be accomplished through observation during the above imitation and supervision phases.

END OF LESSON CONFIRMATION

QUESTIONS

- Q1. When is horseplay allowed on the range?
- Q2. The contents of the Range Standing Orders shall be read to whom?
- Q3. What direction must rifles be pointed while on the range?

ANTICIPATED ANSWERS

- A1. Never, it is forbidden.
- A2. Everyone.
- A3. Down range at all times.

CONCLUSION

HOMEWORK/READING/PRACTICE

Study "Range Commands and Action" chart prior to all range practices.

METHOD OF EVALUATION

The instructor will confirm the cadets' ability to employ the rules and commands of an air rifle range during the handling test and range practice.

CLOSING STATEMENT

Firearms safety is the number one priority on and off the range, so everyone must do their part to prevent accidents. In marksmanship, the majority of incidents are caused by either ignorance of proper rifle operating procedures, or by mishandling.

INSTRUCTOR NOTES/REMARKS

N/A.

REFERENCES

A0-027 A-CR-CCP-177/PT-001 D Cds 3. (2001). *Canadian Cadet Movement: Cadet Marksmanship Programme Reference Manual*. Ottawa, ON: Department of National Defence.

THIS PAGE INTENTIONALLY LEFT BLANK



COMMON TRAINING INSTRUCTIONAL GUIDE



SECTION 5

EO M106.05 – CLEAN AND STORE THE CADET AIR RIFLE

Total Time:

30 min

INTRODUCTION

PRE-LESSON INSTRUCTIONS

A complete list of resources needed for the instruction of this EO is located at Chapter 2 of the QSP. Specific uses for said stores are identified throughout the Instructional Guide, within the teaching point for which they are required.

Prior to instructing this lesson the instructor shall:

- review the lesson content, and become familiar with the material; and
- prepare a mock air rifle range to be used in the conduct of the lesson.

PRE-LESSON ASSIGNMENT

N/A.

APPROACH

This lesson will be presented using the demonstration and performance method. The demonstration-performance method was chosen to allow cadets to participate in supervised exploration of practical instructional material. This method provides the instructor the opportunity to introduce the subject matter, demonstrate and explain procedures, and supervise the cadets while they imitate the skill. This method appeals to all learning styles.

REVIEW

The pertinent review for this lesson, from EO M106.04 (Section 4), will include:

- Q1. When should a rifle be proved safe?
- Q2. What does the acronym “GRIT” stand for?
- Q3. In what direction must rifles be pointed while on the range?

ANTICIPATED ANSWERS

- A1. When picked up, handed to or received from another person.
- A2. Group, Range, Indication, and Time.
- A3. Downrange at all times.

OBJECTIVES

By the end of this lesson the cadet shall be expected to clean and store the cadet air rifle during a range practice.

IMPORTANCE

Many inaccuracy complaints can be traced back to a dirty bore. Therefore, air rifles must be cleaned and maintained on a regular basis in order to ensure proper operation and sustained accuracy.

Teaching Point 1

Explain and Demonstrate the Procedure for Cleaning the Cadet Air Rifle

Time: 15 min

Method: Demonstration and Performance

THE IMPORTANCE OF CLEANING THE AIR RIFLE



No one should attempt to clean a rifle until individual safety precautions have been performed on the rifle, and it is certain that the barrel is clear of any obstructions.

It is important to keep the air rifle clean because a dirty bore will eventually cause accuracy problems. Although air rifles do not suffer from powder deposits as do small bore and large bore rifles, they do experience a build-up of residue in the barrel.

WHEN TO CLEAN THE AIR RIFLE

There are four main times to clean the cadet air rifle:

1. Before firing.
2. After firing.
3. Periodically.
4. Before storage.



Cadets will not actually be cleaning the air rifle during this period of instruction. This may be done after participating in a range practice.

CLEANING PROCEDURE FOR THE AIR RIFLE

When	Action
Before firing	Fire two to three felt cleaning pellets.
After firing	Fire two to three felt cleaning pellets.
Periodically	<ol style="list-style-type: none"> 1. Fire a felt cleaning pellet soaked in SAE 30 motor oil. 2. Wait five minutes. 3. Fire three felt cleaning pellets.

When	Action
Before storage of three months or more.	<ol style="list-style-type: none"> 1. Fire two to three felt cleaning pellets. 2. Fire one felt cleaning pellet soaked in SAE 30 motor oil. 3. Fire three felt cleaning pellets when taking rifle out of storage.

CONFIRMATION OF TEACHING POINT 1

QUESTIONS

- Q1. What must be done before attempting to clean an air rifle?
- Q2. When are the four times an air rifle must be cleaned?
- Q3. How many felt cleaning pellets are fired before participating in a range practice?

ANTICIPATED ANSWERS

- A1. Individual safety precautions.
- A2. Before firing, after firing, periodically, and before storage for three months or more.
- A3. Two to three cleaning pellets will be fired before participating in a range practice.

Teaching Point 2

Explain and Demonstrate the Sequence for Storing the Air Rifle

Time: 10 min

Method: Demonstration and Performance

STORING THE AIR RIFLE IN THE CASE

The sequence for storing the cadet air rifle is the reverse order of the procedure for removing the air rifle from the case:

1. Ensure the open case is pointed in a safe direction.
2. Close the action (bolt forward and closed).
3. Slide safety rod out of the barrel.
4. Place the rifle in the case in the direction of the arrow on the case.
5. Confirm pumping lever is partially open.
6. Confirm the safety catch is ON.
7. Close the case.

CONFIRMATION OF TEACHING POINT 2

QUESTIONS

- Q1. What position is the bolt in for storage?

- Q2. What direction is the rifle placed in the case?
Q3. What position is the safety catch placed in for storage?

ANTICIPATED ANSWERS

- A1. Forward and closed.
A2. In the direction of the arrow on the case.
A3. ON, with no red showing.

END OF LESSON CONFIRMATION

QUESTIONS

- Q1. What must be done before anyone should attempt to clean an air rifle?
Q2. What types of problems can be caused by a dirty bore?
Q3. Before storage cleaning is done when a rifle will be stored for how long?

ANTICIPATED ANSWERS

- A1. They perform individual safety precautions.
A2. It is important to keep the air rifle clean because a dirty bore will eventually cause accuracy problems.
A3. Three months or more.

CONCLUSION

HOMEWORK/READING/PRACTICE

N/A.

METHOD OF EVALUATION

The instructor will confirm cadets' ability to clean and store the cadet air rifle at the end of a range practice.

CLOSING STATEMENT

A dirty air rifle and bore will cause accuracy and operation problems. Therefore, air rifles must be cleaned and maintained on a regular basis in order to ensure proper operation and sustained accuracy.

INSTRUCTOR NOTES/REMARKS

Emphasis must be placed on the safety aspects of this lesson.

REFERENCES

- A0-027 A-CR-CCP-177/PT-001 D Cdts 3. (2001). *Canadian Cadet Movement: Cadet Marksmanship Programme Reference Manual*. Ottawa, ON: Department of National Defence.



COMMON TRAINING INSTRUCTIONAL GUIDE



SECTION 6

EO M106.CA – PARTICIPATE IN A FAMILIARIZATION SHOOT USING THE CADET AIR RIFLE

Total Time:

90 min

INTRODUCTION

PRE-LESSON INSTRUCTIONS

A complete list of resources needed for the instruction of this EO is located at Chapter 2 of the QSP. Specific uses for said stores are identified throughout the Instructional Guide, within the teaching point for which they are required.

Prior to instructing this lesson the instructor shall:

- review the lesson content, and become familiar with the material; and
- prepare an air rifle range IAW A-CR-CCP-177/PT-001, Chapter 1, Section 8, prior to the beginning of the activity.

PRE-LESSON ASSIGNMENT

N/A.

APPROACH

This activity will be presented using the performance method. The performance method was chosen to allow cadets to participate in supervised exploration of practical instructional material. This method appeals to all learning styles.

REVIEW

The pertinent review for this activity is the air rifle handling test. All cadets, prior to being allowed to fire the cadet air rifle, must complete the handling test.

OBJECTIVES

By the end of this lesson the cadet shall be expected to have participated in a familiarization shoot using the cadet air rifle.

IMPORTANCE

The experience of practicing the skills learned in previous lessons will help to confirm the cadets' marksmanship skills. Marksmanship is a skill which must be learned, and which will only improve through, practice on the range. This practice is essential to building up experience and developing a "feel" for marksmanship.

Teaching Point 1**Conduct a Range Briefing**

Time: 10 min

Method: Interactive Lecture

ACTIVITY – RANGE BRIEFING

Time: 10 min

OBJECTIVE

The range briefing is required to pass on vital information required for the safe execution of a range practice.

RESOURCES

Local Range Standing Orders for the range that will be used for the practice.

ACTIVITY LAYOUT

The cadets are to receive a range briefing prior to the start of any range activity, to include:

- The reading of all pertinent sections of the local range standing orders.
- A review of rules and commands on an air rifle range (EO M106.04 [Section 4]).
- A review of the layout of the air rifle range.
- A reminder for cadets to practice proper hygiene by washing their hands after firing.

SAFETY

N/A.

INSTRUCTOR GUIDELINES

- Review local range standing orders.
 - Prepare a full briefing in order to be thorough and organized.
 - Arrange cadets to ensure all can fully observe the instructor.
-

Teaching Point 2**Conduct Cadet Air Rifle Handling Test**

Time: 20 min

Method: Performance

ACTIVITY – HANDLING TEST

Time: 20 min

OBJECTIVE

The air rifle handling test is required to ensure safe rifle handling at all times on the range.

RESOURCES

- Air rifle handling test provided at Chapter 3 of the QSP.
- Cadet air rifle.

ACTIVITY LAYOUT

Qualified range staff, using the form provided at Chapter 3 of the QSP, will test all cadets who have not successfully completed a handling test during the current training year.

SAFETY

- Ensure complete control at all times, and ensure cadets treat air rifles as though they are loaded at all times.
- Ensure test is conducted toward a safe direction, away from other people.

INSTRUCTOR GUIDELINES

- Review procedure for air rifle handling test.
- Prepare an organized plan for testing all cadets who require it.
- Ensure a plan is in place for retraining those cadets that are unsuccessful.

Teaching Point 3

Participate in a Familiarization Shoot

Time: 60 min

Method: Performance



This activity will be conducted under the supervision of a qualified Range Safety Officer (RSO).

ACTIVITY – FAMILIARIZATION SHOOT

Time: 60 min

OBJECTIVE

The purpose of this familiarization shooting activity is to introduce marksmanship in the Canadian Cadet Movement (CCM).

RESOURCES

- Cadet air rifles.
- Air rifle safety rods.
- Safety glasses/goggles.
- Pellets.
- Suitable targets.
- Range assistants.
- A qualified Range Safety Officer (RSO).

ACTIVITY LAYOUT

N/A.

SAFETY

All standard range safety procedures will apply.

INSTRUCTOR GUIDELINES

- The RSO shall ensure that all rules and procedures are strictly adhered to.
- Cadets shall successfully complete the air rifle handling test prior to firing pellets on a cadet air rifle range.

N/A.

END OF LESSON CONFIRMATION

N/A.

CONCLUSION

HOMEWORK/READING/PRACTICE

N/A.

METHOD OF EVALUATION

There is no formal assessment of this activity.

CLOSING STATEMENT

The cadets are to be allowed to review their targets and, assisted by senior cadets, select targets that may be eligible for recognition under the CCM Shooting Program.

INSTRUCTOR NOTES/REMARKS

N/A.

REFERENCES

- A0-027 A-CR-CCP-177/PT-001 D Cdts 3. (2001). *Canadian Cadet Movement: Cadet Marksmanship Programme Reference Manual*. Ottawa, ON: Department of National Defence.
- A2-003 D Cdts. (2005). CATO 14-41, *Annex E, Appendix 1, Marksmanship, Rifles, and Ammunitions*. In *Cadet Administrative and Training Orders (Vol. 1, 8 pages)*. Ottawa, ON: Department of National Defence.



COMMON TRAINING INSTRUCTIONAL GUIDE



SECTION 7

EO C106.01 – PARTICIPATE IN A RECREATIONAL SHOOT USING THE CADET AIR RIFLE

Total Time: 90 min

INTRODUCTION

PRE-LESSON INSTRUCTIONS

A complete list of resources needed for the instruction of this EO is located at Chapter 2 of the QSP. Specific uses for said stores are identified throughout the Instructional Guide, within the teaching point for which they are required.

Prior to instructing this lesson the instructor shall:

- review the lesson content, and become familiar with the material; and
- prepare an air rifle range IAW A-CR-CCP-177/PT-001, Chapter 1, Section 8, prior to the beginning of the activity.

PRE-LESSON ASSIGNMENT

N/A.

APPROACH

The performance method was chosen to allow cadets to participate in supervised exploration of practical instructional material. This method appeals to all learning styles.

REVIEW

The pertinent review for this activity is the air rifle handling test. All cadets, prior to being allowed to fire the cadet air rifle, must complete the handling test.

OBJECTIVES

By the end of this lesson the cadet shall be expected to participate in a recreational shoot using the cadet air rifle.

IMPORTANCE

The experience of practicing the skills learned in PO 106 (Chapter 6) will help to enhance the cadets' marksmanship skills. Marksmanship is a skill which must be learned, and which will only improve, through practice on the range. This practice is essential to building up experience and developing a "feel" for marksmanship.

Teaching Point 1**Conduct a Range Briefing**

Time: 10 min

Method: Interactive Lecture

ACTIVITY – RANGE BRIEFING

Time: 10 min

OBJECTIVE

The range briefing is required to pass on vital information required for the safe execution of a range practice.

RESOURCES

Local Range Standing Orders for the range that will be used for the practice.

ACTIVITY LAYOUT

The cadets are to receive a range briefing prior to the start of any range activity, to include:

- The reading of all pertinent sections of the local range standing orders.
- A review of rules and commands on an air rifle range (EO M106.04 [Section 4]).
- A review of the layout of the air rifle range.
- A reminder for cadets to practice proper hygiene by washing their hands after firing.

SAFETY

N/A.

INSTRUCTIONAL GUIDELINES

- Review local range standing orders.
 - Prepare a full briefing in order to be thorough and organized.
 - Arrange cadets to ensure all can fully observe the instructor.
-

Teaching Point 2**Conduct Cadet Air Rifle Handling Test**

Time: 20 min

Method: Performance

ACTIVITY – HANDLING TEST

Time: 20 min

OBJECTIVE

The air rifle handling test is required to ensure safe rifle handling at all times on the range.

RESOURCES

- Air rifle handling test provided at Chapter 3 of the QSP.
- Cadet air rifle.

ACTIVITY LAYOUT

Qualified range staff, using the form provided at Chapter 3 of the QSP, will evaluate all cadets who have not successfully completed a handling test during the current training year.

SAFETY

- Ensure complete control at all times, and ensure cadets treat air rifles as though they are loaded at all times.
- Ensure test is conducted toward a safe direction, away from other people.

INSTRUCTIONAL GUIDELINES

- Review procedure for air rifle handling test.
- Prepare an organized plan for testing all cadets who require it.
- Ensure a plan is in place for retraining those cadets that are unsuccessful.

Teaching Point 3

Participate in a Recreational Shoot

Time: 60 min

Method: Performance



This activity will be conducted under the supervision of a qualified Range Safety Officer (RSO).

ACTIVITY – RECREATIONAL SHOOT

Time: 60 min

OBJECTIVE

The purpose of this recreational shooting activity is to raise the standard of marksmanship in the Canadian Cadet Movement (CCM).

RESOURCES

- Cadet air rifles.
- Cadet air rifle safety rods.
- Safety glasses/goggles.
- Pellets.
- Suitable targets.
- Range assistants.
- A qualified RSO.

ACTIVITY LAYOUT

- This activity shall be conducted as per established range practices.
- The cadets are to be allowed to review their targets.

SAFETY

All standard range safety procedures will apply.

INSTRUCTIONAL GUIDELINES

- The RSO shall ensure that all rules and procedures are strictly adhered to.
- Cadets shall successfully complete the air rifle handling test prior to firing pellets on a cadet air rifle range.

	<p>Suggested recreational shooting activities may include:</p> <ul style="list-style-type: none">• timed events;• different style targets; and• biathlon drop plate targets.
---	--

END OF LESSON CONFIRMATION

N/A.

CONCLUSION

HOMEWORK/READING/PRACTICE

N/A.

METHOD OF EVALUATION

There is no formal assessment of this activity.

CLOSING STATEMENT

The cadets are to be allowed to review their targets and, assisted by senior cadets, select targets that may be eligible for recognition under the Recreational Shooting Program.

INSTRUCTOR NOTES/REMARKS

N/A.

REFERENCES

- A0-027 A-CR-CCP-177/PT-001 D Cdts 3. (2001). *Canadian Cadet Movement: Cadet Marksmanship Programme Reference Manual*. Ottawa, ON: Department of National Defence.
- A2-003 D Cdts. (2005). CATO 14-41, *Annex E, Appendix 1, Marksmanship, Rifles, and Ammunitions*. In *Cadet Administrative and Training Orders (Vol. 1, 8 pages)*. Ottawa, ON: Department of National Defence.

PARTS AND CHARACTERISTICS OF THE CADET AIR RIFLE

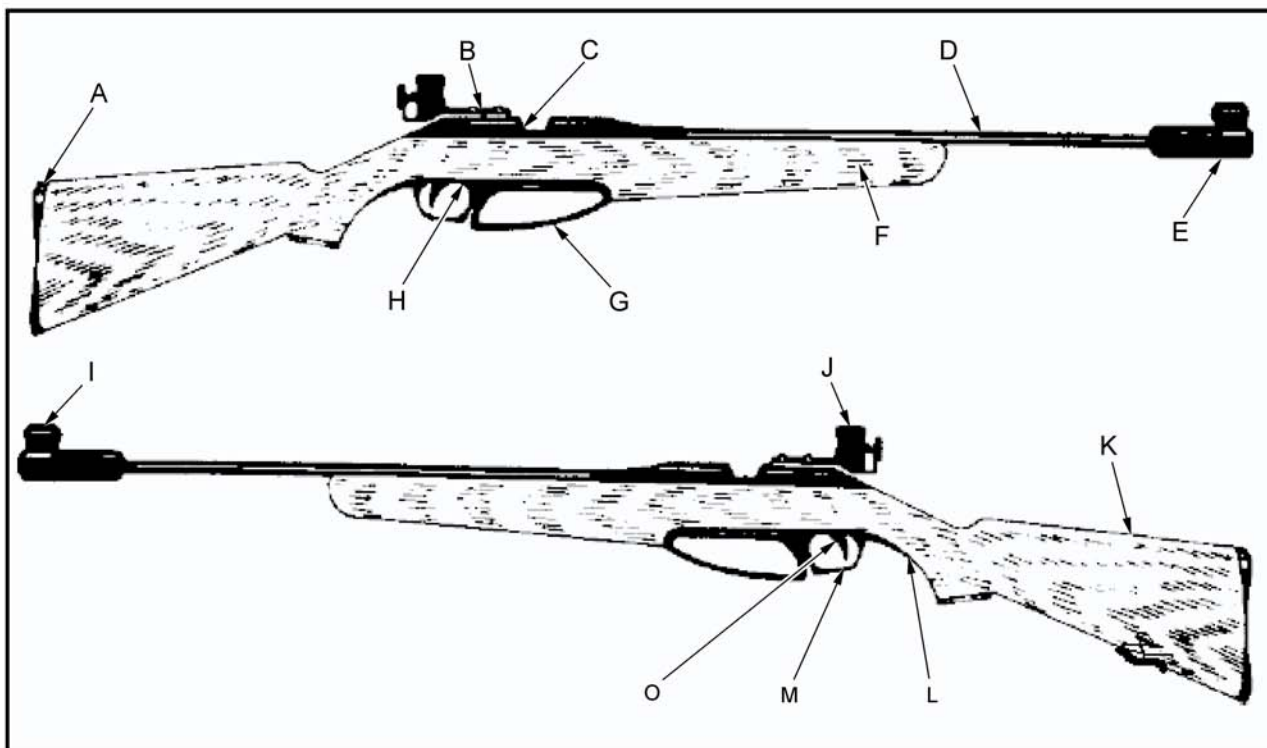

Put the letter next to the matching name of the part of the cadet air rifle.

- | | | | |
|----------------------|-------|-------------------|-------|
| 1. Feed Track | _____ | 8. Safety Catch | _____ |
| 2. Small of the Butt | _____ | 9. Muzzle | _____ |
| 3. Barrel | _____ | 10. Pump Lever | _____ |
| 4. Fore End | _____ | 11. Front Sight | _____ |
| 5. Rear Sight | _____ | 12. Trigger Guard | _____ |
| 6. Trigger | _____ | 13. Butt Plate | _____ |
| 7. Bolt | _____ | 14. Stock | _____ |

ANSWER KEY

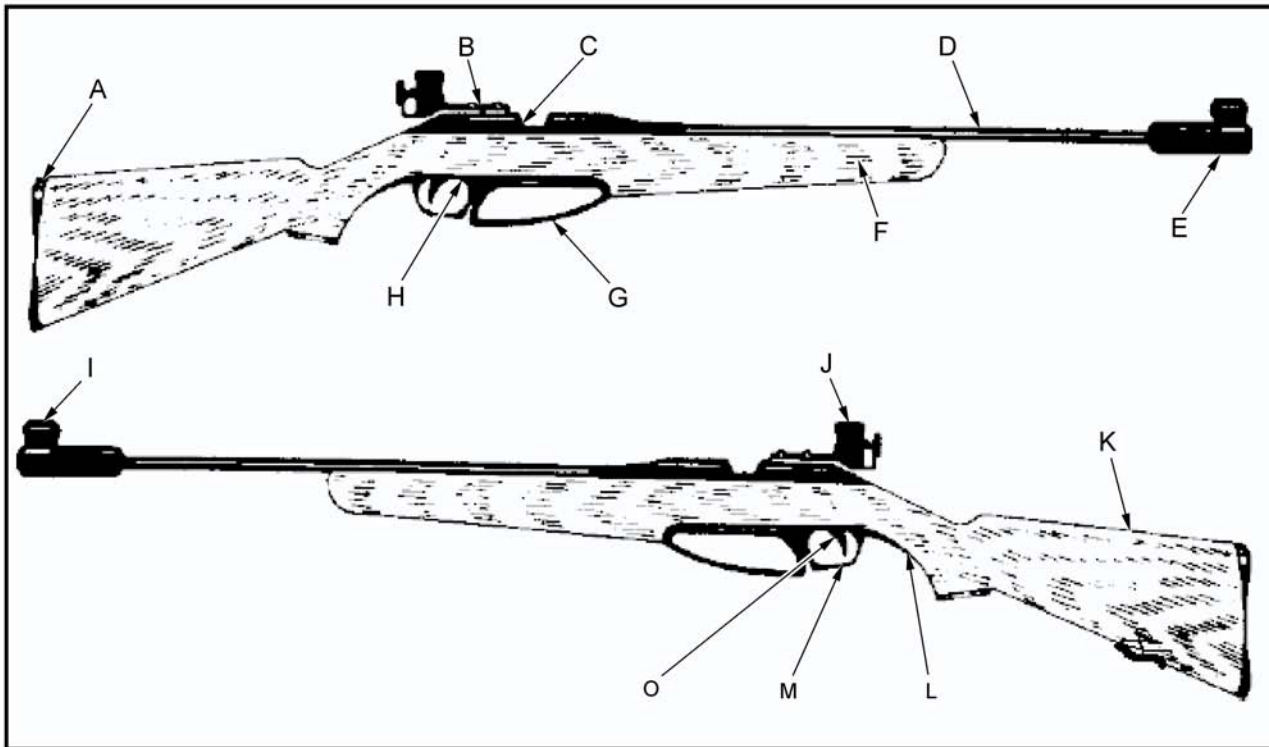

Put the letter next to the matching name of the part of the cadet air rifle.

- | | | | |
|----------------------|------------------------------|-------------------|------------------------------|
| 1. Feed Track | <u> C </u> | 8. Safety Catch | <u> H </u> |
| 2. Small of the Butt | <u> L </u> | 9. Muzzle | <u> E </u> |
| 3. Barrel | <u> D </u> | 10. Pump Lever | <u> G </u> |
| 4. Fore End | <u> F </u> | 11. Front Sight | <u> I </u> |
| 5. Rear Sight | <u> J </u> | 12. Trigger Guard | <u> M </u> |
| 6. Trigger | <u> O </u> | 13. Butt Plate | <u> A </u> |
| 7. Bolt | <u> B </u> | 14. Stock | <u> K </u> |

RANGE COMMANDS

Command	Action
"Cover off your firing point"	Stand up, move behind the firing point and await further commands.
"Place your equipment down and stand back"	Lay the equipment down on the mat and stand back when finished.
"Adopt the prone position"	Adopt the prone position, pick up the rifle, ready the equipment and put on hearing and eye protection.
Type of firing – "G.R.I.T."	This command includes information about the range and type of firing, i.e. Relay No._____, 10 metres, 5 rounds, Grouping, On Your Own Time.
"Relay, load, commence firing"	<ol style="list-style-type: none"> 1. Pick up and hold the rifle with the left hand. 2. Ensure the safety catch is in the ON position. 3. Pump the rifle. 4. When the pump lever is fully extended, pause for about 3 seconds. 5. Load the pellet. 6. Close the bolt. 7. Place the safety catch in the OFF position; aim the rifle at the target. 8. Squeeze the trigger. 9. Open the bolt. 10. Repeat the sequence for each shot. 11. Place the safety catch in the ON position and partially open the pump lever immediately after firing the practice. 12. Lay down the rifle.
MAY BE GIVEN	
"Relay, cease fire"	Stop firing immediately, put the safety catch in the ON position and lay the rifle down.
"Relay, resume fire"	Put the safety in the OFF position and continue the practice.

Command	Action
"Relay, unload"	<ol style="list-style-type: none"> 1. Pick up the rifle. 2. Remove the five-pellet clip if used. 3. Open the bolt. 4. Pump the rifle. 5. Close the bolt. 6. Place the safety catch in the OFF position. 7. Aim rifle at target. 8. Pull the trigger. 9. Place safety catch in the ON position.
"Relay, prepare for inspection"	<ol style="list-style-type: none"> 1. Open the bolt. 2. Open the pump lever 5 to 8 cm. 3. Place rifle on shoulder, muzzle pointed down range. 4. Wait to be cleared by the RSO. 5. Lay the rifle down. 6. Remove your hearing and eye protection.
"Relay, stand up"	Stand up and leave the equipment on the ground.
"Change targets"	Move forward, walk down the lane to remove old targets and replace them with new ones. Return to the firing point.
"Change relays"	Cadets who have just fired pick up their personal equipment and move off the firing point. The new relay covers off behind the firing point.

A-CR-CCP-177/PT-001, Cadet Marksmanship Program Reference Manual

CHAPTER 7

PO 107 – SERVE IN AN AIR CADET SQUADRON



ROYAL CANADIAN AIR CADETS

LEVEL ONE

INSTRUCTIONAL GUIDE



SECTION 1

EO M107.01 – DISCUSS YEAR ONE TRAINING

Total Time: 30 min

INTRODUCTION

PRE-LESSON INSTRUCTIONS

A complete list of resources needed for the instruction of this EO is located at Chapter 2 of the QSP. Specific uses for said stores are identified throughout the Instructional Guide, within the teaching point for which they are required.

Prior to instructing this lesson the instructor shall:

- review the lesson content and become familiar with the material;
- prepare a set of Performance Objective (PO) index cards as described in the activity for TP1;
- compile information regarding total periods for each PO (mandatory and complementary) and the activities associated with each PO, including support days (e.g. familiarization flying, field exercises, models, tours, speakers, etc.); and
- create a list of optional training offered at the squadron, including timings, participation requirements and restrictions.

PRE-LESSON ASSIGNMENT

N/A.

APPROACH

The small group activity was selected to allow for maximum participation in the learning process. It is an interactive way to illustrate and substantiate the lesson material in a concrete manner.

The interactive lecture method was chosen as it allows the instructor to make a semi-formal presentation of the material where the cadets can participate by asking or responding to questions and commenting on the material. For this lesson, this method is most effective as it matches well the taxonomic level of the material and is age-appropriate by virtue of its participatory nature.

REVIEW

N/A.

OBJECTIVES

By the end of this lesson the cadet shall be expected to identify:

- the PO's associated with objectives taught in level one; and

- squadron optional training opportunities.

IMPORTANCE

Having an overview of the training opportunities available in Level One prepares new cadets for the training year. They will be able to see how training fits together and identify areas of interest.

Teaching Point 1

Conduct an Activity to Introduce Level One POs

Time: 15 min

Method: Activity

BACKGROUND KNOWLEDGE

PERFORMANCE OBJECTIVES

The Cadet Training Program is divided into subjects called Performance Objectives (POs). There are 15 POs in Level One.

Level 1 (PO and Topic)	Description
101 – Citizenship	Discuss various Canadian symbols that are found at the squadron and in the community.
102 – Community Service	Participate in activities that benefit the community and promote good citizenship.
103 – Leadership	Discuss characteristics of followers, set personal goals and participate in team building activities.
104 – Personal Fitness and Healthy Living	Identify activities that will help achieve a healthy lifestyle and develop a personal activity plan.
105 – Recreational Sports	Participate in various sporting activities.
106 – Marksmanship	Learn the safe handling procedures and techniques in the firing of the cadet air rifle.
107 – General Cadet Knowledge	Discuss training opportunities, identify and address squadron members, wear the cadet uniform.
108 – Drill	Perform basic movements at the halt and on the march to participate in squadron parades.
120 – CF Familiarization	Participate in Canadian Forces familiarization activities and identifying the mission and objectives of the CF and the role of the Air Force in the CF.
121 – Aviation Community Familiarization	Participate in Canadian Aviation, Aerospace and Aerodrome Operations Community familiarization activities.
129 – Radio Communication	Communicate using the phonetic alphabet and numbers.

Level 1 (PO and Topic)	Description
130 – Aviation Activities	Identify aircraft as military, civilian and cadet, describe the main components of an airplane and become familiar with aviation history.
140 – Aerospace	Become familiar with important events in space history and build a model rocket.
160 – Aerodrome Operations	Construct a model aerodrome to become familiar with major aerodrome components and features of a runway.
190 – Aircrew Survival	Participate in an overnight aircrew survival exercise.

ACTIVITY

Time: 15 min

OBJECTIVE

This activity is designed to familiarize the cadet with the POs associated with Level One.

RESOURCES

- Index cards with one of the 15 PO numbers and topics.
- Index cards with one of the 15 PO descriptions.

ACTIVITY LAYOUT

1. Prior to the lesson, prepare index cards based on the topic and description provided in the background information. Distribute the index cards to the cadets. The index cards should be taped under chairs or placed face down on the desks.
2. Before starting the activity, ask the cadets what kind of things they think they will learn in the Air Cadet Program.
3. The cadets will look at their cards. Randomly select one of the cadets to read their card aloud.
 - If the card is a PO topic, the cadet who thinks they have the description to match it on their card will read out their answer.
 - If the card outlines a PO description, the cadet who thinks they have the PO topic to match it will read out their answer.
4. The remainder of the cadets in the class should indicate whether they agree or disagree with this match.
5. If the match is incorrect, ask for another cadet who thinks they have the correct match to read it.
6. If the match is correct, confirm it and provide some detail about the PO including periods allotted to it, support day and activities. The index cards should then be posted on the wall.
7. Randomly select another cadet to read their card aloud.
8. The game will continue until all PO topics and descriptions have been covered.

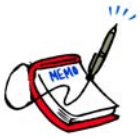

In classes of less than 30 cadets, some cadets will have more than one card.

In classes of more than 30 cadets, provide extra description cards so that all cadets have a card.

SAFETY

N/A.

INSTRUCTOR GUIDELINES

- Encourage cadets to participate.
- Provide hints if no one is answering.
- Be enthusiastic about all training opportunities discussed.
- Answer any questions the cadets ask about training.
- Correct or redirect wrong matches.
- Praise correct matches.

CONFIRMATION OF TEACHING POINT 1

QUESTIONS

Q1. What POs are you most interested in?

ANTICIPATED ANSWERS

A1. Will vary by cadet.

Teaching Point 2

Time: 10 min

Discuss Squadron Optional Training

Method: Interactive Lecture

SQUADRON OPTIONAL TRAINING

In addition to the mandatory training, the squadron may also offer extracurricular activities, called optional training. This may include, but is not limited to:

- bands;
- drill teams;
- sports teams;
- interest clubs;
- ground school;
- biathlon;
- marksmanship;
- trips and tours; and

- special events.

Days of training, timings, level of participation and any other important details should be included.



Discuss only optional activities provided by the squadron. Cadets or staff members involved with those specific activities can be invited to give short presentations.

CONFIRMATION OF TEACHING POINT 2

QUESTIONS

Q1. Which optional activities are you most interested in?

ANTICIPATED ANSWERS

A1. Will vary by cadet.

END OF LESSON CONFIRMATION

QUESTIONS

Q1. Name one of the subjects taught in year one (go around the class until all POs have been listed).

Q2. Name one optional activity offered by the squadron (go around the class until the main activities are covered).

ANTICIPATED ANSWERS

- A1. Citizenship.
 Community Service.
 Leadership.
 Personal Fitness and Healthy Living.
 Recreational Sports.
 Marksmanship.
 General Cadet Knowledge.
 Drill.
 CF Familiarization.
 Aviation Community Familiarization.
 Radio Communication.
 Aviation Activities.
 Aerospace.
 Aerodrome Operations.

Aircrew Survival.

A2. Will vary by squadron.

CONCLUSION

HOMEWORK/READING/PRACTICE

The squadron training calendar will have information on optional activities.

METHOD OF EVALUATION

There is no formal assessment of this EO.

CLOSING STATEMENT

There is a wide variety of training available in Level One. Cadets should look for opportunities to become involved in activities that interest them. The more activities cadets get involved in at the unit, the more they will enjoy and benefit from the program.

INSTRUCTOR NOTES/REMARKS

Much of the material in this lesson will be specific to each squadron. The squadron training plan must be reviewed in order to accurately represent the mandatory, complementary and support days.

REFERENCES

A3-002 CATO 54-10 Cadets Canada. (1995). CATO 54-10, Local Headquarters Training: Air Cadets. In Cadet Administrative and Training Orders (Vol. 5, 4 pages). Ottawa, ON.



ROYAL CANADIAN AIR CADETS

LEVEL ONE

INSTRUCTIONAL GUIDE



SECTION 2

EO M107.02 – IDENTIFY AIR CADET RANKS AND AIR OFFICER RANKS

Total Time:

30 min

INTRODUCTION

PRE-LESSON INSTRUCTIONS

A complete list of resources needed for the instruction of this EO is located at Chapter 2 of the QSP. Specific uses for said stores are identified throughout the Instructional Guide, within the teaching point for which they are required.

Prior to instructing this lesson the instructor shall:

- review the lesson content, and become familiar with the material;
- confirm all materials from the activity resource lists are available;
- obtain a set of cadet rank badges and/or slip-ons and (if possible) a set of officer slip-ons from the squadron supply;
- prepare visual aids of the cadet and officer ranks (e.g. pictures, rank poster, overheads, etc.);
- prepare sets of index cards with one each of the Air Cadet rank badges (enough sets to provide each cadet with a card) for TP2 activity; and
- prepare sets of index cards with one each of the officer ranks through to captain (enough sets to provide each cadet with a card) for TP4 activity.

PRE-LESSON ASSIGNMENT

N/A.

APPROACH

The interactive lecture method was chosen as it allows the instructor to make a semi-formal presentation of the material where the cadets can participate by asking or responding to questions and commenting on the material. For this lesson, this method is most effective as it matches well the taxonomic level of the material and is age-appropriate by virtue of its participatory nature.

The small group activity was selected to allow for maximum participation in the learning process. It is an interactive way to illustrate and substantiate the lesson material in a concrete manner.

REVIEW

N/A.

OBJECTIVES

By the end of this lesson the cadet shall be expected to identify Air Cadet and officer ranks.

IMPORTANCE

It is important that the cadets be able to identify the ranks of both cadets and officers in order to pay proper marks of respect. It is a matter of courtesy to address people by their correct rank.

Teaching Point 1

Identify Air Cadet Ranks

Time: 6 min

Method: Interactive Lecture

CADET RANKS

Every cadet in the squadron has a rank. Ranks are an indication of the experience and responsibility of each cadet.

Air Cadet (AC)

Cadets will start at the rank of Air Cadet upon enrolment.

There is no badge for the rank of Air Cadet.

Leading Air Cadet (LAC)

Cadets will be promoted to the rank of Leading Air Cadet upon completion of six months of training.

The Leading Air Cadet badge is a propeller. When worn on the jacket it is worn on the upper sleeves, centred midway between the shoulder seam and the point of the elbow.



Adapted from Rank Badges. Retrieved 30 March 2006, from http://www.cadets.ca/aircad/resources-ressources/symbols/air_pages_all/air_rank.html.

Figure 7-2-1 Leading Air Cadet Rank Badge

Corporal (Cpl)

Cadets may be promoted to the rank of Corporal after successfully completing proficiency Level One.

The Corporal rank badge has two chevrons. When worn on the jacket it is worn on the upper sleeves, centred midway between the shoulder seam and the point of the elbow.



Adapted from Rank Badges. Retrieved 30 March 2006, from http://www.cadets.ca/aircad/resources-ressources/symbols/air_pages_all/air_rank.html.

Figure 7-2-2 Corporal Rank Badge

Sergeant (Sgt)

The Sergeant rank badge has three chevrons. When worn on the jacket it is worn on the upper sleeves, centred midway between the shoulder seam and the point of the elbow.



Adapted from Rank Badges. Retrieved 30 March 2006, from http://www.cadets.ca/aircad/resources-ressources/symbols/air_pages_all/air_rank.html.

Figure 7-2-3 Sergeant Rank Badge

Flight Sergeant (FSgt)

The Flight Sergeant rank badge has three chevrons and a crown. When worn on the jacket it is worn on the upper sleeves, centred midway between the shoulder seam and the point of the elbow.



Adapted from Rank Badges. Retrieved 30 March 2006, from http://www.cadets.ca/aircad/resources-ressources/symbols/air_pages_all/air_rank.html.

Figure 7-2-4 Flight Sergeant Rank Badge

Warrant Officer Second Class (WO 2)

The Warrant Officer Second Class badge is a crown encircled by a wreath. When worn on the jacket it is worn on the lower sleeves, centred midway between the bottom of the cuff and the point of the elbow.



Adapted from Rank Badges. Retrieved 30 March 2006, from http://www.cadets.ca/aircad/resources-ressources/symbols/air_pages_all/air_rank.html.

Figure 7-2-5 Warrant Officer Second Class Rank Badge

Warrant Officer First Class (WO 1)

Warrant Officer First Class is the highest rank a cadet may achieve.

The Warrant Officer First Class badge is the Canadian Coat of Arms. When worn on the jacket it is worn on the lower sleeves, centred midway between the bottom of the cuff and the point of the elbow.



Adapted from Rank Badges. Retrieved 30 March 2006, from http://www.cadets.ca/aircad/resources-ressources/symbols/air_pages_all/air_rank.html.

Figure 7-2-6 Warrant Officer First Class Rank Badge



Ranks are also worn as slip-ons on the all-season jacket and the short sleeve shirt. Slip-ons are worn on both shoulders.



Bringing the badges and/or slip-ons into the classroom to hand around for the cadets to look at would add an element of realism to the class.

CONFIRMATION OF TEACHING POINT 1

QUESTIONS

- Q1. What is the highest rank a cadet may achieve?
- Q2. Which rank has three chevrons?
- Q3. To what rank is a cadet promoted to upon completion of six months of training?

ANTICIPATED ANSWERS

- A1. Warrant Officer First Class.
- A2. Sergeant.
- A3. Leading Air Cadet.

Teaching Point 2

Conduct an Air Cadet Ranks Activity

Time: 6 min

Method: Activity

ACTIVITY

Time: 6 min

OBJECTIVE

The objective of this activity is for cadets to become familiar with Air Cadet ranks.

RESOURCES

- Paper copies of each rank found in Annex A (use as many ranks as the number of cadets in the class. If there are more than seven cadets, there can be more than one cadet with the same rank).
- Tape.

ACTIVITY LAYOUT

1. Explain the activity before beginning. Cadets will have a rank on their back, and they will not know what it is. By asking each other questions about their ranks, they are to determine what rank they are wearing.
2. Tape rank pictures to the back of each cadet (the cadet does not get to see the rank that is on their back). Cadets should not talk while this is being done.
3. The cadets are to walk around and ask other cadets yes/no questions to determine what rank they are wearing. For example, "Do I have two chevrons?" The cadet is to determine from the answers what rank they are.
4. The cadets can only ask one question to each of the other cadets to determine what rank they are. This will ensure the cadets are interacting fully with the other members of the class.
5. Once cadets think they have determined what rank they are, they will group with other cadets who are the same rank, if there are any.
6. After three minutes, the cadets present what rank they think they are based on the information they have received. For example, if a group has determined they have only two chevrons on their back, they would present themselves as the corporal group/individual.

SAFETY

Ensure there is an open area in the classroom that the cadets can easily walk around in.

INSTRUCTOR GUIDELINES

- Ensure that cadets do not take their ranks off to look at them or have another cadet tell them what rank is on their back.
- Ensure that the cadets have a full understanding of how to ask the right questions before starting the activity.

Teaching Point 3

Identify the Air Officer Rank Structure

Time: 7 min

Method: Interactive Lecture



The instructor should make the cadets aware that they will not usually encounter senior or general officers at the squadron. However, some larger squadrons may have a major as the commanding officer. More emphasis should be placed on the subordinate and junior officers during the lesson.

SUBORDINATE OFFICER – OFFICER CADET

The Officer Cadet rank is identified by one thin gold braid.



www.forces.gc.ca/site/Community/insignia/aira_e.asp

Figure 7-2-7 Officer Cadet Rank

JUNIOR OFFICERS

Once an officer is promoted to the rank Second Lieutenant they become a commissioned member of the Canadian Forces. Receiving a commission means that a person has been recognized by the monarchy (Queen or King) to serve as an officer.

Second Lieutenant (2Lt)

The rank of Second Lieutenant is identified by one thick gold braid.



www.forces.gc.ca/site/Community/insignia/aira_e.asp

Figure 7-2-8 Second Lieutenant Rank

Lieutenant (Lt)

The rank of Lieutenant is identified by one thick gold braid, with one thin gold braid on top of it.



www.forces.gc.ca/site/Community/insignia/aira_e.asp

Figure 7-2-9 Lieutenant Rank

Captain (Capt)

The rank of Captain is identified by two thick gold braids.



www.forces.gc.ca/site/Community/insignia/aira_e.asp

Figure 7-2-10 Captain Rank

SENIOR OFFICERS

Major (Maj)

The rank of Major is identified by two thick gold braids with one thin gold braid in between.



www.forces.gc.ca/site/Community/insignia/aira_e.asp

Figure 7-2-11 Major Rank

Lieutenant Colonel (LCol)

The rank of Lieutenant Colonel is identified by three thick gold braids.



www.forces.gc.ca/site/Community/insignia/aira_e.asp

Figure 7-2-12 Lieutenant Colonel Rank

Colonel (Col)

The rank of Colonel is identified by four thick gold braids.



www.forces.gc.ca/site/Community/insignia/aira_e.asp

Figure 7-2-13 Colonel Rank

GENERAL OFFICERS

General officers are unique in that there are two manners to distinguish their ranks. All four of these ranks will wear one extra thick braid on the sleeve of their dress uniform. To distinguish between the four general ranks, there are differences in their epaulettes. All of the epaulettes will have a crown over a crossed sabre and baton, with the distinguishing feature being the number of maple leaves under the swords.

Brigadier General (BGen)

The rank of Brigadier General is identified by one maple leaf under the swords.



www.forces.gc.ca/site/Community/insignia/aira_e.asp

Figure 7-2-14 Brigadier General Rank

Major General (MGen)

The rank of Major General is identified by two maple leaves under the swords.



www.forces.gc.ca/site/Community/insignia/aira_e.asp

Figure 7-2-15 Major General Rank

Lieutenant General (LGen)

The rank of Lieutenant General is identified by three maple leaves in a triangular pattern under the swords.



www.forces.gc.ca/site/Community/insignia/aira_e.asp

Figure 7-2-16 Lieutenant General Rank

General (GEN)

The rank of General is identified by four maple leaves in a diamond pattern under the swords.



www.forces.gc.ca/site/Community/insignia/aira_e.asp

Figure 7-2-17 General Rank

CONFIRMATION OF TEACHING POINT 3

QUESTIONS

- Q1. What is the lowest rank that an Air Officer may hold?
- Q2. Which rank has two thick gold braids?
- Q3. How many braids does a Lieutenant wear?

ANTICIPATED ANSWERS

- A1. Officer Cadet.
- A2. Captain.
- A3. One narrow and one wide braid.

Teaching Point 4**Conduct an Air Officer Ranks Activity**

Time: 6 min

Method: Activity

ACTIVITY – RANK TRADE

Time: 6 min

OBJECTIVE

The objective of this activity is for cadets to become familiar with the Air Officer ranks.

RESOURCES

Pictures of Air Officer ranks from OCdt to Capt on index cards, as found in Annex B (one card per cadet).

ACTIVITY LAYOUT

- Distribute index cards, one for each cadet.
- Direct cadets to introduce their rank to another cadet. When both cadets have introduced their ranks, they will trade cards. Repeat so that each cadet has traded with three different cadets.
- Direct the cadets to form groups based on the ranks they are holding.
- Direct the groups to form a line of ranks, in order, from OCdt to Capt.

SAFETY

N/A.

INSTRUCTOR GUIDELINES

- Ensure the cadets are properly introducing their ranks.
- Answer questions that may arise.
- Confirm the cadets' success.

END OF LESSON CONFIRMATION

Direct cadets to complete the rank matching exercise in their handbook, which corresponds to this EO. The cadets should have two minutes to complete the exercise, working in pairs. The instructor will then review the correct answers. This exercise can be completed on the cadets' own time if class time runs out.

CONCLUSION

HOMEWORK/READING/PRACTICE

More information on the senior officer ranks can be found in the cadet handbooks. Encourage the cadets to refer to staff by rank and name as much as possible.

METHOD OF EVALUATION

There is no formal assessment of this EO. Instructors will confirm cadets' comprehension of the material during parade nights and other activities at the squadron.

CLOSING STATEMENT

Every member of the squadron has a rank. It is important to be able to recognize cadets and officers by their rank in order to demonstrate the proper respect. Practicing rank recognition and knowing the officers at the squadron is vital for cadets to be able to serve as a member of the squadron. Rank recognition is the first step in knowing and following the chain of command.

INSTRUCTOR NOTES/REMARKS

N/A.

REFERENCES

- A3-004 CATO 51-02 Cadets Canada. (2002). CATO 51-02, Air Cadet Promotions. In Cadet Administrative and Training Orders (Vol. 5, 9 pages). Ottawa, ON.
- A3-005 QR&O 3.01 Departments of National Defence. (2006). QR&O 3.01, *Ranks and Designation of Rank*. In Queen's Regulations and Orders for the Canadian Forces (Vol. 1, Chapter 3). Ottawa, ON.



COMMON TRAINING INSTRUCTIONAL GUIDE



SECTION 3

EO M107.03 – OBSERVE THE RULES AND PROCEDURES FOR THE PAYING OF COMPLIMENTS

Total Time:

30 min

INTRODUCTION

PRE-LESSON INSTRUCTIONS

A complete list of resources needed for the instruction of this EO is located at Chapter 2 of the QSP. Specific uses for said stores are identified throughout the Instructional Guide, within the teaching point for which they are required.

Prior to instructing this lesson the instructor is required to:

- review the lesson content, and become familiar with the material;
- assign handbook reading to cadets that relates to this EO; and
- prepare a suitable classroom area.

PRE-LESSON ASSIGNMENT

Prior to the lesson, the cadet shall have read the handbook material related to this EO. The material covers origins of saluting and supplementary information on appropriate occasions to pay compliments.

APPROACH

The interactive lecture method was chosen as it allows the instructor to make a semi-formal presentation of the material where the cadets can participate by asking or responding to questions and commenting on the material. For this lesson, this method is most effective as it matches well the taxonomic level of the material and is age-appropriate by virtue of its participatory nature.

The small group activity was selected to allow for maximum participation in the learning process. It is an interactive way to illustrate and substantiate the lesson material in a concrete manner.

REVIEW

N/A.

OBJECTIVES

By the end of this lesson the cadet shall be expected to know when and where to pay compliments.

IMPORTANCE

Knowledge gained during this lesson will be applied when addressing and interacting with officers and NCOs at the corps/squadron and the Cadet Summer Training Centre.

Teaching Point 1**Explain the Procedures for Addressing Cadet NCOs and Subordinate Officers**

Time: 7 min

Method: Interactive Lecture/Activity

ADDRESSING CADET NCOs AND SUBORDINATE OFFICERS

It is important to pay the correct compliments to the appropriate individuals.

When addressing a cadet NCO or a subordinate officer, the cadet will stand at the position of attention. As cadet NCOs and subordinate officers do not hold a commission from the Queen, they are not saluted. Throughout the conversation, the cadet shall address the NCO or subordinate officer by their rank and surname and remain at the position of attention. When the cadet has completed addressing the NCO or officer, they should dismiss themselves appropriately by turning to the right.



The instructor should demonstrate this process prior to moving on to the activity.

ACTIVITY

Time: 3 min

OBJECTIVE

To allow cadets to practice the procedures for addressing cadet NCOs and subordinate officers.

RESOURCES

Role-play area.

ACTIVITY LAYOUT

- Dependent on time, the cadets can be divided into groups and practice these procedures with their peers.
- If time does not allow, call for volunteers to come to the front of the class. In this case, the instructor shall play the role of the NCO or subordinate officer.
- Have cadets practice the procedures for addressing cadet NCOs and subordinate officers, including:
 - approaching the NCO/subordinate officer and standing at the position of attention;
 - addressing the NCO/subordinate officer by their rank and surname; and
 - dismissal.

SAFETY

N/A.

INSTRUCTOR GUIDELINES

Ensure there is a sufficient area to conduct the role-play activity.

CONFIRMATION OF TEACHING POINT 1

QUESTIONS

- Q1. Do cadet NCOs and subordinate officers hold a commission from the Queen?
- Q2. If they do not hold a commission, are they saluted?
- Q3. Name an action the cadet should take while addressing a cadet NCO/subordinate officer.

ANTICIPATED ANSWERS

- A1. No, they do not hold a commission.
- A2. No, they are not saluted.
- A3. Standing at the position of attention, addressing by rank and surname, and dismissing appropriately.

Teaching Point 2**Explain the Procedures for Addressing a Commissioned Officer**

Time: 5 min

Method: Interactive Lecture/Activity

ADDRESSING COMMISSIONED OFFICERS

When addressing commissioned officers, the same procedures are followed as when addressing NCOs and subordinate officers except a salute shall be given.

The cadet shall stand at the position of attention after approaching the commissioned officer. The cadet will then give the appropriate salute as outlined in A-PD-201-000/PT-000, *Canadian Forces Manual of Drill and Ceremonial*. Throughout the conversation the cadet shall address the commissioned officer by their rank and surname and always remain at the position of attention unless otherwise directed by the commissioned officer. When the cadet has completed addressing the officer, they should again salute and dismiss themselves appropriately.



The instructor should demonstrate this process prior to moving on to the activity.

ACTIVITY

Time: 3 min

OBJECTIVE

To allow cadets to practice the procedures for addressing commissioned officers.

RESOURCES

Role-play area.

ACTIVITY LAYOUT

- Dependent on time, the cadets can be divided into groups and practice these procedures with their peers.
- If time does not allow, call for volunteers to come to the front of the class. In this case, the instructor shall play the role of the commissioned officer.
- Have cadets practice the procedures for addressing commissioned officers, including:
 - approaching the commissioned officer and standing at the position of attention;
 - saluting;
 - addressing the commissioned officer by their rank and surname;
 - saluting prior to dismissal; and
 - dismissal.

SAFETY

N/A.

INSTRUCTOR GUIDELINES

Ensure there is a sufficient area to conduct the role-play activity.

CONFIRMATION OF TEACHING POINT 2

QUESTIONS

- Q1. Are you required to salute commissioned officers? Why?
- Q2. When should the commissioned officer be saluted?

ANTICIPATED ANSWERS

- A1. Yes. They hold a commission from the Queen.
- A2. After the officer has been approached and prior to dismissal.

Teaching Point 3

Explain Regulations for Paying Compliments Inside a Building

Time: 9 min

Method: Interactive Lecture/Activity

PAYING COMPLIMENTS INSIDE A BUILDING

Salutes are not given inside buildings except when on parade, during ceremonial occasions, or when entering and leaving offices. Cadets, however, shall turn their head and offer a polite greeting when meeting an officer in a common area. It is not customary to wear headdress inside a building.

Entering an Office

When entering an office the cadet shall:

- stand at the position of attention in the doorway;
- salute if wearing headdress and the office occupant holds a commission; and

- politely ask permission to enter the office.

Leaving an Office

When leaving an office the cadet shall:

- stand at the position of attention in the doorway;
- salute if wearing headdress and the office occupant holds a commission; and
- depart.



The instructor should demonstrate this process prior to moving on to the activity.



RCAC Level One Handbook, Cadets Canada, 1993

Figure 7-3-1 Entering and Leaving an Office

ACTIVITY

Time: 5 min

OBJECTIVE

To allow cadets to practice the procedures for entering and leaving offices.

RESOURCES

Role-play area.

ACTIVITY LAYOUT

- Dependent on time, the cadets can be divided into groups and practice these procedures with their peers.

- If time does not allow, call for volunteers to come to the front of the class. In this case, the instructor shall play the role of the office occupant.
- Have cadets practice the procedures for entering and leaving offices, including:
 - Entering:
 - stand at the position of attention in the doorway when entering;
 - salute if wearing headdress and the office occupant holds a commission; and
 - politely ask permission to enter the office.
 - Leaving:
 - stand at the position of attention in the doorway when leaving the office;
 - salute if wearing headdress and the office occupant holds a commission; and
 - depart.

SAFETY

N/A.

INSTRUCTOR GUIDELINES

Ensure there is a sufficient area to conduct the role-play activity.

CONFIRMATION OF TEACHING POINT 3

QUESTIONS

Q1. Name two times or places where compliments are paid inside a building.

ANTICIPATED ANSWERS

A1. Parade square, ceremonial occasions, entering and leaving offices.

Teaching Point 4

Explain Other Occasions To Pay Compliments

Time: 4 min

Method: Interactive Lecture

OTHER OCCASIONS TO PAY COMPLIMENTS

It is appropriate for cadets to salute on different occasions:

- When the Canadian or another foreign national anthem is played.
- When recognizing a commissioned officer who is not in uniform.
- When The National Flag of Canada is being lowered or raised.
- When boarding or disembarking any of Her Majesty's Canadian ships or those of a foreign service, cadets shall pay compliments to the quarterdeck.

CONFIRMATION OF TEACHING POINT 4

QUESTIONS

- Q1. Does one salute when recognizing a commissioned officer out of uniform?
- Q2. Does one pay compliments if the Star Spangled Banner is played?

ANTICIPATED ANSWERS

- A1. Yes, compliments shall be paid.
- A2. Yes, compliments are paid for all national anthems.

END OF LESSON CONFIRMATION

This lesson will be confirmed by verbal questioning.

CONCLUSION

HOMEWORK/READING/PRACTICE

N/A.

METHOD OF EVALUATION

There is no formal assessment of this EO. Instructors will confirm cadets' comprehension of the material during parade nights and other activities at the corps/squadron.

CLOSING STATEMENT

The cadets have learned how to address cadet NCOs, subordinate and commissioned officers; how to pay compliments inside a building; and other occasions on which to salute. Knowledge gained during this lesson will be applied when addressing and interacting with officers and NCOs at the corps/squadron and at the Cadet Summer Training Centre.

INSTRUCTOR NOTES/REMARKS

N/A.

REFERENCES

- A0-002 A-PD-201-000/PT-000 National Defence. (2001). *The Canadian Forces Manual of Drill and Ceremonial*. Ottawa, ON: National Defence.

THIS PAGE INTENTIONALLY LEFT BLANK



ROYAL CANADIAN AIR CADETS

LEVEL ONE

INSTRUCTIONAL GUIDE



SECTION 4

EO M107.04 – STATE THE AIMS AND MOTTO OF THE AIR CADET PROGRAM

Total Time:

30 min

INTRODUCTION

PRE-LESSON INSTRUCTIONS

A complete list of resources needed for the instruction of this EO is located at Chapter 2 of the QSP. Specific uses for said stores are identified throughout the Instructional Guide, within the teaching point for which they are required.

Prior to instructing this lesson the instructor shall:

- review the lesson content, and become familiar with the material;
- prepare a suitable classroom area; and
- prepare puzzles for the end of lesson confirmation.

PRE-LESSON ASSIGNMENT

N/A.

APPROACH

The small group activity was selected to allow for maximum participation in the learning process. It is an interactive way to illustrate and substantiate the lesson material in a concrete manner.

The interactive lecture method was chosen as it allows the instructor to make a semi-formal presentation of the material where the cadets can participate by asking or responding to questions and commenting on the material. For this lesson, this method is most effective as it matches well the taxonomic level of the material and is age-appropriate by virtue of its participatory nature.

REVIEW

N/A.

OBJECTIVES

By the end of this lesson the cadet shall be expected to be familiar with the mission and vision of the Cadet Program and state the aims and motto of the Air Cadet Program.

IMPORTANCE

Knowing the aims and motto of the Air Cadet Program are fundamental for any cadet. This information will give cadets a better understanding of how the Cadet Program can help them develop as a cadet and an individual.

Teaching Point 1

Conduct a Brainstorming Activity on the Mission of the Cadet Program

Time: 5 min

Method: Activity



Conduct the brainstorming activity outlined below before stating the mission.

ACTIVITY

Time: 5 min

OBJECTIVE

The objective of this activity is for the cadets to brainstorm ideas about what they think the Cadet Program mission is.

RESOURCES

- Flipchart paper.
- Flipchart markers.

ACTIVITY LAYOUT

- Separate the class into two groups.
- Give each group a piece of flipchart paper and a marker.
- Direct each group to brainstorm ideas about what they think the mission (or objective) of the Cadet Program is.
- Give the groups two minutes to complete this activity.
- After the two minutes have elapsed, have each group present their ideas.
- Finish the activity by stating the mission of the Cadet Program.

SAFETY

N/A.

INSTRUCTOR GUIDELINES

- During the activity, monitor the cadets' progress and ensure all members of the class are participating.
- Answer any questions the cadets may have.
- Provide a simplified definition of a mission if the cadets are experiencing difficulty during this activity.

MISSION

The mission of the Cadet Program is to contribute to the development and preparation of youth for the transition to adulthood, enabling them to meet the challenges of modern society, through a dynamic, community-based program.

CONFIRMATION OF TEACHING POINT 1

Q1. What is the mission of the Cadet Program?

ANTICIPATED ANSWER

A1. The mission of the Cadet Program is to contribute to the development and preparation of youth for the transition to adulthood, enabling them to meet the challenges of modern society, through a dynamic, community-based program.

Teaching Point 2**Conduct a Brainstorming Activity on the Vision of the Cadet Program**

Time: 5 min

Method: Activity



Conduct the brainstorming activity outlined below before stating the vision.

ACTIVITY

Time: 5 min

OBJECTIVE

The objective of this activity is for the cadets to brainstorm ideas about what they think the Cadet Program vision is.

RESOURCES

- Flipchart paper.
- Flipchart markers.

ACTIVITY LAYOUT

- Separate the class into two groups.
- Give each group a piece of flipchart paper and a marker.
- Direct each group to brainstorm ideas about what they think the vision of the Cadet Program is.
- Give the groups two minutes to complete this activity.
- After the two minutes have elapsed, have each group present their ideas.
- Finish the activity by stating the vision of the Cadet Program.

SAFETY

N/A.

INSTRUCTOR GUIDELINES

- During the activity, monitor the cadets' progress and ensure all members of the class are participating.
- Answer any questions the cadets may have.
- Provide a simplified definition of a vision if cadets are having difficulty during this activity.

VISION

The vision of the Cadet Program is a relevant, credible and proactive youth development organization, offering the program of choice for Canada's youth, preparing them to become the leaders of tomorrow through a set of fun, challenging, well organized and safe activities.

CONFIRMATION OF TEACHING POINT 2

QUESTIONS

Q1. What is the vision of the Cadet Program?

ANTICIPATED ANSWERS

A1. The vision of the Cadet Program is a relevant, credible and proactive youth development organization, offering the program of choice for Canada's youth, preparing them to become the leaders of tomorrow through a set of fun, challenging, well organized and safe activities.

Teaching Point 3

Describe the Three Aims of the Cadet Program

Time: 7 min

Method: Interactive Lecture

DEVELOP IN YOUTH THE ATTRIBUTES OF GOOD CITIZENSHIP AND LEADERSHIP

The Cadet Program aims to assist in the development of cadets as good citizens and leaders.

Through citizenship and community services activities, the cadet develops an appreciation for community membership and involvement within cadet, local, regional, provincial, national, and global communities. Cadets' active involvement will have a positive impact on local communities, which will contribute to community strength and vibrancy.

Through leadership activities, cadets develop interpersonal skills and assume responsibility as effective team members, leaders and dynamic coaches. They will develop the ability to conduct themselves in an ethical and socially responsible way.

PROMOTE PHYSICAL FITNESS

The Cadet Program aims to promote physical well-being. Cadets develop an understanding of the benefits of fitness and a healthy lifestyle. This understanding, combined with ongoing participation in fitness activities, aids in the development of positive attitudes and behaviours that build resiliency within cadets and enable them to meet challenges.

STIMULATE THE INTEREST OF YOUTH IN THE SEA, LAND AND AIR ACTIVITIES OF THE CANADIAN FORCES (CF)

The Cadet Program aims to expose youth to the sea, land and air activities of the CF. Cadets develop elemental skills through introduction and interaction with their respective CF communities. The Cadet Program educates and promotes liaison with civilian maritime, adventure and aviation communities. These combined experiences and interactions are essential to the unique identity of the Sea, Army and Air Cadet organizations. Also, they distinguish the Cadet Program as a whole from other youth development programs.

CONFIRMATION OF TEACHING POINT 3

QUESTIONS

- Q1. What are the three aims of the Cadet Program?
- Q2. How does the Cadet Program help in developing good citizens and leaders?
- Q3. How does the Cadet Program promote physical fitness?
- Q4. How does the Cadet Program stimulate an interest in the sea, land and air activities of the Canadian Forces?

ANTICIPATED ANSWERS

- A1. Develop in youth the attributes of good citizenship and leadership, promote physical fitness and stimulate the interest of youth in the sea, land and air activities of the CF.
- A2. Through citizenship and community services activities, the cadet develops an appreciation for community membership and involvement within cadet, local, regional, provincial, national, and global communities. Cadets' active involvement will have a positive impact on local communities, which will contribute to community strength and vibrancy.

Through leadership activities, cadets develop interpersonal skills and assume responsibility as effective team members, leaders and dynamic coaches. They will develop the ability to conduct themselves in an ethical and socially responsible way.

- A3. The Cadet Program aims to promote physical well-being. Cadets develop an understanding of the benefits of fitness and a healthy lifestyle. This understanding, combined with ongoing participation in fitness activities, aids in the development of positive attitudes and behaviours that build resiliency within cadets and enable them to meet challenges.
- A4. The Cadet Program aims to expose youth to the sea, land and air activities of the CF. Cadets develop elemental skills through introduction and interaction with their respective CF communities. The Cadet Program educates and promotes liaison with civilian maritime, adventure and aviation communities. These combined experiences and interactions are essential to the unique identity of the Sea, Army and Air Cadet organizations. Also, they distinguish the Cadet Program as a whole from other youth development programs.

Teaching Point 4

State the Motto of the Air Cadet Program

Time: 3 min

Method: Interactive Lecture

MOTTO

The motto of the Air Cadet Program is: To Learn – To Serve – To Advance.

- To Learn – the cadets learn new things throughout the program from qualified people, from various fields of expertise.
- To Serve – the cadet learns how to serve in the community and within their local squadron.
- To Advance – the cadet is able to advance through the program by gaining knowledge and then passing their knowledge and experience on to other cadets.

CONFIRMATION OF TEACHING POINT 4

QUESTIONS

- Q1. What is the motto of the Air Cadet Program?
- Q2. What does “To Learn” mean?
- Q3. What does “To Serve” mean?
- Q4. What does “To Advance” mean?

ANTICIPATED ANSWERS

- A1. To Learn – To Serve – To Advance.
- A2. The cadet learns new things throughout the program from qualified people, from various fields of expertise.
- A3. The cadet learns how to serve in the community and within their local squadron.
- A4. The cadet is able to advance through the program by gaining knowledge and then passing their knowledge and experience on to other cadets.



Other answers to questions 2 to 4 may arise. Each aspect of the motto can mean something different for each cadet.

END OF LESSON CONFIRMATION

ACTIVITY

Time: 5 min

OBJECTIVE

The objective of this activity is to confirm the teaching points of the lesson. Cadets will have to assemble puzzles of the mission, vision, aim and motto of the Air Cadet Program.

RESOURCES

- Puzzles found in Annex C.
- Envelopes.

ACTIVITY LAYOUT

- Cut each puzzle found in Annex C and place each into a separate envelope.
- Separate the class into four groups.
- Give each group an envelope with a puzzle in it.
- Direct each group to piece together the puzzle in the envelope.
- When the puzzles are complete, have a member of each group read out what their puzzle says.
- Finish the activity by reconfirming each puzzle.

SAFETY

N/A.

INSTRUCTOR GUIDELINES

- During the activity, the instructor will supervise the cadets' progress and ensure all members of the class are participating.
- The instructor will answer any questions the cadets may have.

CONCLUSION

HOMEWORK/READING/PRACTICE

N/A.

METHOD OF EVALUATION

There is no formal assessment of this EO.

CLOSING STATEMENT

The aims and motto of the Air Cadet Program provide the cadet with a greater understanding of what it means to be an Air Cadet, and will foster a sense of pride in belonging to the Air Cadet Program.

INSTRUCTOR NOTES/REMARKS

N/A.

REFERENCES

- A0-003 Cadets Canada. (1999). CATO 11-03, *Aim of the Canadian Cadet Organizations*. In Cadet Administrative and Training Orders (Vol. 1). Ottawa, ON.

THIS PAGE INTENTIONALLY LEFT BLANK



ROYAL CANADIAN AIR CADETS

LEVEL ONE

INSTRUCTIONAL GUIDE



SECTION 5

EO M107.05 – WEAR THE AIR CADET UNIFORM

Total Time:	60 min
-------------	--------

INTRODUCTION

PRE-LESSON INSTRUCTIONS

A complete list of resources needed for the instruction of this EO is located at Chapter 2 of the QSP. Specific uses for said stores are identified throughout the Instructional Guide, within the teaching point for which they are required.

Prior to instructing this lesson the instructor shall:

- review the lesson content, and become familiar with the material;
- gather all necessary uniform parts, badges, and accessories to be introduced to the cadets; and
- ensure a senior cadet is available to be in the class for demonstration purposes.

PRE-LESSON ASSIGNMENT

N/A.

APPROACH

The interactive lecture method was chosen as it allows the instructor to make a semi-formal presentation of the material where the cadets can participate by asking or responding to questions and commenting on the material. For this lesson, this method is most effective as it matches well the taxonomic level of the material and is age-appropriate by virtue of its participatory nature.

REVIEW

N/A.

OBJECTIVES

By the end of this lesson the cadet shall be expected to properly care for and wear the Air Cadet uniform to the standard set forth in CATO 55-04, *Royal Canadian Air Cadet Dress Instructions*.

IMPORTANCE

The cadet uniform is highly recognizable and the standard of personal dress and appearance. Grooming shall be such as to reflect credit on the individual and the Canadian Cadet Organization (CCO).

Teaching Point 1**Explain the Correct Manner to Wear Headdress**

Time: 5 min

Method: Interactive Lecture



As each piece of uniform is being presented, the instructor should explain and show the proper wear and care (where applicable) of the piece using a senior cadet as a demonstrator.

WEDGE

The wedge shall be worn on the right side of the head with the lower point of the front crease in the centre of the forehead and with the front edge of the cap 2.5 cm above the right eyebrow. Two air force buttons must be attached in pre-cut holes at the front.

WEDGE INSIGNIA

The wedge insignia is to be worn on the left side of the wedge with the centre of the badge positioned mid-way between the front and mid-point of the wedge.

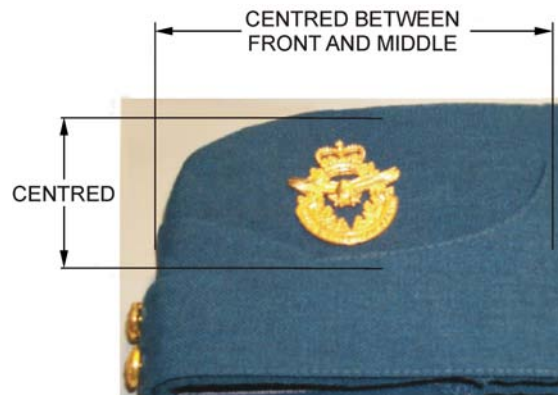

Royal Canadian Air Cadet Dress Instructions

Figure 7-5-1 Placement of Wedge Insignia

WIDE BRIMMED TAN SUMMER HAT

The wide brimmed tan summer hat may be worn during summer activities for which the wedge is unsuitable.

TOQUE

The toque may be worn outside when weather conditions dictate.

CONFIRMATION OF TEACHING POINT 1

QUESTIONS

- Q1. On what side of the wedge is the insignia worn?
- Q2. Where are the two air force buttons placed on the wedge?
- Q3. When and where can the toque be worn?

ANTICIPATED ANSWERS

- A1. Left side.
- A2. In pre-cut holes on the front of the wedge.
- A3. Outside when weather conditions dictate.

Teaching Point 2**Explain the Correct Manner to Wear and Care for Clothing Articles on the Upper Body**

Time: 7 min

Method: Interactive Lecture



As each piece of uniform is being presented, the instructor should explain and show the proper wear and care (where applicable) of the piece using a senior cadet as a demonstrator.

SHORT SLEEVE SHIRT

The short sleeve shirt may be worn with or without the tie. It can also be worn with or without the jacket. It shall be kept clean and pressed. The only crease is to be down the centre of each sleeve starting at the centre of each epaulette. The shirt shall be tucked into the pants and the top button shall remain open when not wearing the tie.

NECKTIE

The necktie shall be knotted neatly using a Windsor or four-in-hand knot and shall be kept tight. Plain gold colour tie clips or pins may be used. When the jacket is removed, the tie shall not be tucked into the shirt except for safety reasons.



WINDSOR KNOT

Royal Canadian Air Cadet Dress Instructions

Figure 7-5-2 Method for Tying a Windsor Knot



FOUR-IN-HAND KNOT

Royal Canadian Air Cadet Dress Instructions

Figure 7-5-3 Method for Tying a Four-in-Hand Knot



The instructor can briefly show the class the two methods for tying the tie. This information is also found in the handbook for reference purposes when the cadets are practicing on their own time.

LIGHT BLUE COTTON T-SHIRT

The light blue cotton T-shirt may be worn with the appropriate orders of dress. It shall be wrinkle free at all times.

TURTLENECK SWEATER

The turtleneck sweater may be worn with or without the jacket but the jacket must be worn when proceeding to and from the squadron's location. Sleeves shall not be rolled or taken up.

JACKET AND JACKET BELT

The cadet jacket with cloth belt shall be worn fully buttoned with the exception of the top button. Jackets may be removed in buildings and offices when authorized. The jacket shall be kept clean and pressed. The sleeves of the jacket shall be roll pressed with no creases. The jacket belt shall be worn so as the excess of the belt, once attached, is on the left side of the buckle. The buckle shall be adjusted so that the excess of the belt on the left side is not more than 8 cm.

ALL-SEASON JACKET

The all-season jacket may be worn year round when weather conditions dictate. The liner and the exterior jacket may be worn separately or as a set. Rank slip-ons shall be worn on both.

RANK SLIP-ONS

Rank slip-ons shall be worn on both shoulders with the short-sleeve shirt, the all-season jacket, with the CF flying suit at the flying site for authorized cadets and with CF combat clothing during squadron survival exercises when authorized by the squadron CO.

GREY SPORTS T-SHIRT

The grey sports T-shirt shall be worn as directed by the squadron or CSTC CO.

BLACK GLOVES AND MITTS

Plain black civilian pattern gloves and mitts may be worn with the overcoat, parka, or all-season jacket when weather conditions dictate.

NAMETAG

The nametag shall be made of a blue and white laminated plastic plate 6.3 cm in length and 1.2 cm in height. It shall be inscribed with white lettering 0.6 cm high and shall indicate only the surname of the cadet. The nametag is worn over the right breast pocket and should be detachable.

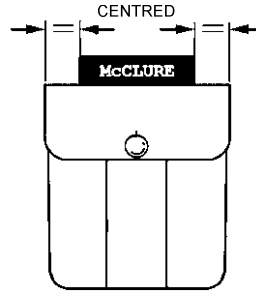

Royal Canadian Air Cadet Dress Instructions

Figure 7-5-4 Right Breast Pocket with Nametag

CONFIRMATION OF TEACHING POINT 2

QUESTIONS

- Q1. What are the two methods for tying the tie?
- Q2. Where are the creases in the short sleeve shirt placed?
- Q3. How are the sleeves of the jacket pressed?

ANTICIPATED ANSWERS

- A1. Windsor and four-in-hand knots.
- A2. The only crease to be in the shirt is to be down the centre of each sleeve starting at the centre of each epaulette.
- A3. The sleeves of the jacket shall be roll pressed with no creases.

Teaching Point 3

Explain the Correct Manner to Wear And Care for the Trousers and Shorts

Time: 6 min

Method: Interactive Lecture



As each piece of uniform is being presented, the instructor should explain and show the proper wear and care (where applicable) of the piece using a senior cadet as a demonstrator.

TROUSERS

The trousers shall be steam pressed without starch so as to have creases down the centre of each leg in the front and the back. Creases shall extend from the top of the leg to the bottom and shall not be sewn or glued.

BLACK BELT

The black belt shall be worn with the trousers such that the buckle is centred and the ends are “brass on brass”. Brass on brass is when the end of the belt meets the brass buckle, and when the belt is done up, there is no black showing between the two pieces of brass. The belt may need to be adjusted in order for this to occur.

GREY SPORTS SHORTS

The grey sports shorts shall be worn as directed by the squadron or CSTC CO.

CONFIRMATION OF TEACHING POINT 3

QUESTIONS

- Q1. Where are the creases in the trousers placed?
- Q2. How is the buckle on the belt worn?

ANTICIPATED ANSWERS

- A1. The trousers are pressed to have creases down the centre of each leg in the front and the back. Creases shall extend from the top of the leg to the bottom.
- A2. Centred with the ends brass on brass.

Teaching Point 4

Explain the Correct Manner to Wear and Care for Footwear

Time: 7 min

Method: Interactive Lecture



As each piece of uniform is being presented, the instructor should explain and show the proper wear and care (where applicable) of the piece using a senior cadet as a demonstrator.

BOOTS

Black ankle boots are to be laced horizontally from side-to-side.



Royal Canadian Air Cadet Dress Instructions

Figure 7-5-5 Method of Lacing Boots

When the boots are tied, the ends of the laces are to be tucked inside the boot. Boots shall not be modified with any type of metal cleats, hobnails or other metal attachments to the heel or sole. No varnish other than shoe polish will be used to shine the boots.

CARE OF THE BOOTS

The black ankle boots should be cleaned and polished on a regular basis. General guidelines for polishing the boots include:

1. The welts of the boot are to be cleaned with an old toothbrush and black boot polish.
2. Use a polish cloth wrapped around the index finger.
3. Apply a moderate amount of polish to the cloth.
4. Apply the polish in a circular motion to the area being polished.
5. Start with large circles to cover the area with polish.
6. Use smaller circles as the polish gets worked into the boot.
7. Continue to work in a circular motion until circles formed by the polish are no longer visible.
8. The whole boot is to be polished, not just the toe.

RUNNING SHOES

Running shoes shall be worn as directed by the squadron or CSTC CO.

GREY WOOL SOCKS

Grey wool socks shall be worn with boots and running shoes. If a cadet suffers from a recognized allergy to wool the cadet may wear grey or black cotton or nylon socks.

CONFIRMATION OF TEACHING POINT 4

QUESTIONS

- Q1. When should grey wool socks be worn?
- Q2. How should the black ankle boots be laced?

ANTICIPATED ANSWERS

- A1. Grey socks shall be worn at all times with boots and issued running shoes unless the cadet suffers from a recognized allergy to wool.
- A2. The black ankle boots should be laced horizontally from side to side.

Teaching Point 5

Explain the Placement of Level One Air Cadet Badges

Time: 7 min

Method: Interactive Lecture

SQUADRON SHOULDER BADGES

Squadron shoulder badges are to be worn on both sleeves of the jacket only. The top of the badge is to be 2 cm below the upper shoulder seam.



Royal Canadian Air Cadet Dress Instructions

Figure 7-5-6 Squadron Shoulder Flash

LAC RANK BADGES

LAC rank badges are to be worn centered on both sleeves of the jacket, midway between the elbow and the upper shoulder seam.



Royal Canadian Air Cadet Dress Instructions

Figure 7-5-7 LAC Rank Badge



All badges are to be sewn onto the jacket neatly and with thread that blends in with the colour of the badge and the uniform.

CONFIRMATION OF TEACHING POINT 5

QUESTIONS

- Q1. What uniform part are the squadron shoulder flashes worn on?
- Q2. How far down the sleeve is the squadron shoulder flash worn?
- Q3. Where are the LAC badges worn on the uniform?

ANTICIPATED ANSWERS

- A1. Only on the jacket.
- A2. 2 cm.
- A3. LAC rank badges are to be worn centered on both sleeves, midway between the elbow and the upper shoulder seam.

Teaching Point 6**Explain Personal Appearance While in Uniform**

Time: 8 min

Method: Interactive Lecture

GENERAL APPEARANCE

Cadets in uniform shall be well groomed with footwear cleaned and shone. Uniforms shall be clean and properly pressed at all times. In particular, buttons, fasteners and zippers shall be kept closed. Pockets shall not bulge. Items such as glasses, sunglasses, glasses cases, pens, pencils, key-rings or paper shall not visibly extend or protrude from pockets or be suspended from waist belts or pockets. Headsets from a radio receiver, tape/CD player or other personal entertainment devices shall not be worn.

Hairstyles

Hair shall be neatly groomed and conservatively styled. The length, bulk and style of hair shall not preclude the proper wear of the wedge. Style and colour shall not be bizarre, exaggerated or of unusual appearance. Unusual colours such as green, bright red, orange, purple, etc. are not permitted.

Male Hairstyles

Male cadets' hair shall be taper trimmed at the back, sides, and above the ears to blend with the hairstyle. It shall be no more than 15 cm in length. When the hair is groomed and wedge is removed, no hair shall touch the ears or fall below the top of the eyebrows.

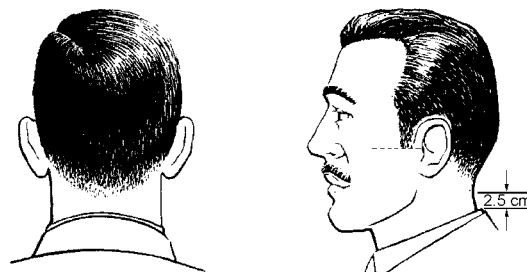

TAPER TRIMMED
HAIRCUT CONVENTIONAL

Royal Canadian Air Cadet Dress Instructions

Figure 7-5-8 Taper Trimmed Haircut – Conventional

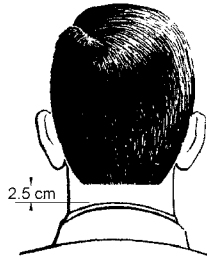

TAPER TRIM HAIRCUT
STRAIGHT BACK APPEARANCE

Royal Canadian Air Cadet Dress Instructions

Figure 7-5-9 Taper Trimmed Haircut – Straight Back Appearance

Sideburns

Sideburns shall not extend below a line horizontally bisecting the ear. They shall be squared off horizontally at the bottom edge and taper trimmed to conform to the overall hairstyle.

Moustaches

When moustaches are worn, the unshaven portion of the face shall not extend outwards beyond the corners of the mouth. Moustaches shall be kept neatly trimmed, not be greater than 2 cm (3/4 in.) in bulk, not extend below the corners of the mouth, and not protrude beyond the width of the mouth.



Canadian Forces Dress Instructions

Figure 7-5-10 Moustache

Female Hairstyles

Female cadets' hair shall not extend below the lower edge of the shirt collar.

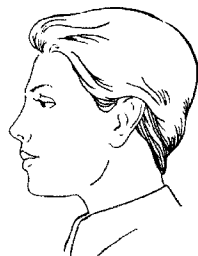

SHORT HAIR STYLE



CURLED HAIR STYLE

Royal Canadian Air Cadet Dress Instructions

Figure 7-5-11 Female Short Hairstyles

Hair may be worn in a bun at the back of the head.

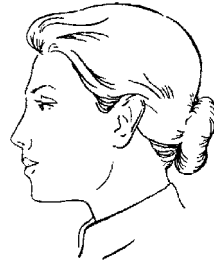

STRAIGHT HAIR STYLE WITH BUN

Royal Canadian Air Cadet Dress Instructions

Figure 7-5-12 Hair Styled in Bun

Braids shall be styled conservatively and tied tightly. They shall be secured at the end by a knot or a small unadorned fastener. A single braid shall be worn in the centre of the back. Double braids shall be worn behind the shoulders. When gathered behind the head and braided hair shall be a maximum length that does not extend below the top of the armpit.



Royal Canadian Air Cadet Dress Instructions

Figure 7-5-13 Single Braid



Royal Canadian Air Cadet Dress Instructions

Figure 7-5-14 Double Braids

Make-up

Female cadets are authorized to wear a minimal amount of make-up. When wearing the uniform, make-up shall be applied conservatively. This precludes the use of false eyelashes, heavy eyeliner, brightly coloured eye shadow or lipstick, coloured nail polish, and excessive facial make-up.

Jewellery

The only jewellery that may be worn in uniform shall be a wristwatch, a medical alert bracelet and a maximum of two rings, which are not of a costume jewellery nature.

Female cadets in uniform may wear a single pair of plain gold studs, silver stud or white pearl earrings in pierced ears. The single stud earring (worn in the centre of each earlobe) shall be spherical in shape and not exceed 0.6 cm in diameter. Male cadets are not authorized to wear an earring or earrings.



Royal Canadian Air Cadet Dress Instructions

Figure 7-5-15 Stud Earring Centred in Earlobe

Tattoos and Piercings

Cadets shall not acquire visible tattoos that could be deemed to be offensive or otherwise reflect discredit on the Canadian Cadet Movement. Cadets in uniform shall not wear visible body piercing adornments (tongue included). Covering the unauthorized piercing with an adhesive bandage is not acceptable.

Accessories

Civilian pattern backpacks shall be of conservative appearance. They may either be carried in the left hand or worn suspended from both shoulders and square on the back.

Female cadets are permitted to carry a purse. The purse is to be held in the left hand or suspended over the left forearm. When the purse is carried as a shoulder bag, the strap shall be suspended from the left shoulder with the top of the purse not higher than waist level. It shall not be carried as a handbag.

Eyeglasses/Sunglasses

Eyeglasses and sunglasses shall be conservative in design and colour. Sunglasses with photo chromic or mirrored lenses are not authorized for wear. Cadets, who normally wear eyeglasses, may wear either conventionally framed prescription sunglasses or conservatively styled clip-on sunglasses when conditions and circumstances dictate. Other cadets may wear conservatively styled sunglasses, which do not detract from the overall appearance of the uniform when conditions and circumstances dictate. Sunglasses shall not be worn when parading unless authorized by the CSTC or Squadron CO in special circumstances.

Carrying of Articles

If any article is being carried, such as a briefcase, it is to be carried in the left hand. If an article is being carried while marching, the left arm is not swung.

Civilian Clothing

Other than those specific items listed in the CATO, civilian clothing shall not be worn with the cadet uniform unless authorized by the CSTC or squadron CO in special circumstances. This includes, but is not limited to, civilian jackets and hats.

General Deportment

Chewing gum, slouching, sauntering, placing hands in pockets, smoking, eating on the street, walking hand-in-hand and similar deportment that detracts from a proud and orderly appearance in the eyes of the public is unacceptable for cadets. Physical displays of affection between uniformed cadets shall be avoided.

CONFIRMATION OF TEACHING POINT 6

QUESTIONS

Q1. What hand should articles be held in?

- Q2. What is the policy on tattoos and piercings?
- Q3. What deportment is unacceptable for cadets?
- Q4. What jewellery is authorized for wear while in uniform?

ANTICIPATED ANSWERS

- A1. Left hand.
- A2. Cadets shall not acquire visible tattoos that could be deemed to be offensive or otherwise reflect discredit on the Canadian Cadet Movement. Cadets in uniform shall not wear visible body piercing adornments (tongue included). Covering the unauthorized piercing with an adhesive bandage is not acceptable.
- A3. Chewing gum, slouching, sauntering, placing hands in pockets, smoking, eating on the street, walking hand-in-hand and similar deportment which detracts from a proud and orderly appearance in the eyes of the public is unacceptable for cadets.
- A4. The only jewellery that may be worn in uniform shall be a wristwatch, a medical alert bracelet and a maximum of two rings, which are not of a costume jewellery nature. Female cadets in uniform may wear a single pair of plain gold studs, silver stud or white pearl earrings in pierced ears.

END OF LESSON CONFIRMATION

ACTIVITY

Time: 10 min

OBJECTIVE

The objective of this activity is to have the cadets properly identify various parts of the uniform and demonstrate the proper wear and care of the piece.

RESOURCES

- Uniform pieces presented in lesson.
- Container for drawing slips of paper.
- Slips of paper with uniform pieces written on them found in Annex D.

ACTIVITY LAYOUT

- Cut out and place the pieces of paper with the uniform parts written on them in a container.
- One at a time, each cadet will chose a slip of paper and find and display the part of the uniform they have chosen.
- After finding the uniform part, the cadet will describe to the class how to properly wear and care for that piece.
- Repeat these steps until each cadet has chosen a piece. If there are more cadets than pieces of uniform, put the pieces of paper back in the container and start again.

SAFETY

N/A.

INSTRUCTOR GUIDELINES

During the activity the instructor will supervise and praise the cadets as they present each piece of the uniform.



The confirmation of this lesson will also take place on a weekly basis as cadets wear their uniforms to squadron activities.

CONCLUSION

HOMEWORK/READING/PRACTICE

N/A.

METHOD OF EVALUATION

There is no formal assessment of this EO. Cadets will be expected to properly wear the Air Cadet uniform on an ongoing basis in accordance with the *Royal Canadian Air Cadet Dress Instructions*. Cadets will be expected to maintain an acceptable standard of personal dress and deportment.

CLOSING STATEMENT

The Air Cadet uniform should be worn properly at all times. The cadet uniform is highly recognizable and the standard of personal dress, appearance, and grooming shall be such as to reflect credit on the individual and on the CCO. The intent is to ensure a high standard of grooming consistent with that expected of cadets.

INSTRUCTOR NOTES/REMARKS

Emphasis must be placed on the cadets' requirement to properly care for and maintain their uniforms at all times. Cadets should learn from the beginning how to properly maintain their uniforms and wear them properly.

This lesson should be delivered at the beginning of the training year before the cadets are expected to wear their uniforms.

REFERENCES

- A0-001 A-AD-265-000/AG-001, DHH 3-2. (2001). *Canadian Forces Dress Instructions*. Ottawa, ON.
- A3-006 Cadets Canada. (2005). CATO 55-04, *Royal Canadian Air Cadet Dress Instructions*. In *Cadet Administrative and Training Orders (Vol. 5)*. Ottawa, ON.



ROYAL CANADIAN AIR CADETS

LEVEL ONE

INSTRUCTIONAL GUIDE



SECTION 6

EO M107.06 – DISCUSS SUMMER TRAINING OPPORTUNITIES

Total Time:

30 min

INTRODUCTION

PRE-LESSON INSTRUCTIONS

A complete list of resources needed for the instruction of this EO is located at Chapter 2 of the QSP. Specific uses for said stores are identified throughout the Instructional Guide, within the teaching point for which they are required.

Prior to instructing this lesson the instructor shall:

- review the lesson content, and become familiar with the material.

PRE-LESSON ASSIGNMENT

N/A.

APPROACH

The interactive lecture method was chosen as it allows the instructor to make a semi-formal presentation of the material where the cadets can participate by asking or responding to questions and commenting on the material. For this lesson, this method is most effective as it matches well the taxonomic level of the material and is age-appropriate by virtue of its participatory nature.

REVIEW

N/A.

OBJECTIVES

By the end of this lesson the cadet shall be expected to identify the summer training opportunities available to year one and shall be introduced to the various summer streams in the Air Cadet Program.

IMPORTANCE

It is important for the cadet to understand the training opportunities available to them during the year one summer so they are aware of what courses they are eligible to attend. It is also important to know what opportunities are available in future summers in order to start thinking about what courses they may wish to complete in the future.

Teaching Point 1**Discuss the Basic Course**

Time: 10 min

Method: Interactive Lecture

AIM

The basic course is two weeks in duration. The aim of the basic course is to familiarize qualified Level One cadets with life at the Cadet Summer Training Centre, introduce cadets to all summer training program areas, and further develop the fundamentals of Air Cadet training.

LOCATIONS

The basic course is conducted at various summer training centres across the country including:

- Albert Head, BC.
- Bagotville, QC.
- Greenwood, NS.
- Penhold, AB.
- Trenton, ON.
- Whitehorse, NWT.



www.theodora.com/maps

Figure 7-6-1 Map of Summer Training Centres Across Canada

The basic course is comprised of the following performance objectives:

- PO 101: Participate in Citizenship Activities.
- PO 103: Participate as a Member of a Team.
- PO 105: Participate in Recreational Sports.

- PO 106: Fire the Cadet Air Rifle.
- PO 107: Serve in an Air Cadet Squadron.
- PO 108: Participate in an Annual Ceremonial Review (ACR) Parade.
- PO 112: Participate in a Music Familiarization Activity.
- PO 130: Participate in Aviation Activities.
- PO 140: Participate in Aerospace Activities.
- PO 160: Participate in Aerodrome Operations Activities.
- PO 190: Participate in a Field Exercise.

CONFIRMATION OF TEACHING POINT 1

QUESTIONS

- Q1. How long is the basic course?
- Q2. Name one location of the basic course.
- Q3. What are two performance objectives of the basic course?

ANTICIPATED ANSWERS

- A1. The basic course is two weeks in duration.
- A2. The basic course is conducted in Albert Head, BC; Bagotville, QC; Greenwood, NS; Penhold, AB; Trenton, ON; and Whitehorse, NWT.
- A3. PO 101: Participate in Citizenship Activities.
- PO 103: Participate as a Member of a Team.
- PO 105: Participate in Recreational Sports.
- PO 106: Fire the Cadet Air Rifle.
- PO 107: Serve in an Air Cadet Squadron.
- PO 108: Participate in an Annual Ceremonial Review (ACR) Parade.
- PO 112: Participate in a Music Familiarization Activity.
- PO 130: Participate in Aviation Activities.
- PO 140: Participate in Aerospace Activities.
- PO 160: Participate in Aerodrome Operations Activities.
- PO 190: Participate in a Field Exercise.

Teaching Point 2**Introduce the Summer Training Program Areas**

Time: 10 min

Method: Interactive Lecture

AVIATION

Aviation summer courses include:

- A three-week Introduction to Aviation Course (ITAC). This course can be taken starting in the summer of year two.
- A three-week Advanced Aviation Course (AAC). This course can be taken starting in the summer of year three.
- A six-week Glider Pilot Scholarship (GPS). This course can be taken starting in the summer of year three.
- A seven-week Power Pilot Scholarship (PPS). This course can be taken starting in the summer of year four.

LEADERSHIP

Leadership summer courses include:

- A three-week Introduction to Leadership Course (ITLC). This course can be taken starting in the summer of year two.
- A six-week Senior Leaders Course (SLC). This course can be taken starting in the summer of year four.

SURVIVAL

Survival summer courses include:

- A three-week Introduction to Survival Training Course (ITSTC). This course can be taken starting in the summer of year two.
- A six-week Survival Instructor Course (SIC). This course can be taken starting in the summer of year three.

AEROSPACE

Aerospace summer courses include:

- A three-week Introduction to Aerospace Course (ITASC). This course can be taken starting in the summer of year two.
- A six-week Advanced Aerospace Course (AASC). This course can be taken starting in the summer of year three.

AVIATION TECHNOLOGY

Aviation technology summer courses include:

- A three-week Introduction to Aviation Technology Course (ITATC). This course can be taken starting in the summer of year two.
- A six-week Advanced Aviation Technology Course – Aircraft Maintenance (AATC-AM). This course can be taken starting in the summer of year three.
- A six-week Advanced Aviation Technology Course – Airport Operations (AATC-AO). This course can be taken starting in the summer of year three.

SPORTS

Sports summer courses include:

- A three-week Introduction to Fitness and Sports Course (ITFASC). This course can be taken starting in the summer of year two.
- A six-week Fitness and Sports Instructor Course (FASC). This course can be taken starting in the summer of year three.

MARKSMANSHIP

Marksmanship has one summer training course; it is a six-week Air Rifle Marksmanship Instructor Course (ARMIC). This course can be taken starting in the summer of year three.

MUSIC

Music summer courses include:

- A three-week Basic Music Course (BMC). This course can be taken starting in the summer of year two.
- A six-week Junior Music Course (JMC). This course can be taken starting in the summer of year three.
- A six-week Intermediate Music Course (IMC). This course can be taken starting in the summer of year three.

TRIPS AND EXCHANGES

The Oshkosh Trip is three weeks in duration and can be taken starting in the summer of year four. The International Air Cadet Exchange (IACE) is three weeks in duration and can be taken starting in the summer of year five.

CONFIRMATION OF TEACHING POINT 2

QUESTIONS

- Q1. What courses are available starting in the summer of year two?
- Q2. What are three of the summer training program areas?

ANTICIPATED ANSWERS

- A1. Introduction to Aviation Course, Introduction to Leadership Course, Introduction to Survival Training Course, Introduction to Aerospace Course, Introduction to Aviation Technology Course, Introduction to Fitness and Sports Course, and Basic Music Course.
- A2. Aviation, leadership, survival, aerospace, aviation technology, sports, marksmanship, music and trips and exchanges.

CONCLUSION

HOMEWORK/READING/PRACTICE

N/A.

METHOD OF EVALUATION

There is no formal assessment of this EO.

CLOSING STATEMENT

Many cadets will have the opportunity to attend summer training centres after completing Level One training at the squadron. It is important for them to know what options are available for their first summer. It is also important for them to gain a basic understanding of opportunities available to them in the future.

INSTRUCTOR NOTES/REMARKS

N/A.

REFERENCES

Summer Training CATO.

C0-043 *Quick Maps*. (2006). Retrieved 10 April 2006, from www.theodora.com/maps.



ROYAL CANADIAN AIR CADETS

LEVEL ONE

INSTRUCTIONAL GUIDE



SECTION 7

EO C107.01 – MAINTAIN THE AIR CADET UNIFORM

Total Time:

60 min

INTRODUCTION

PRE-LESSON INSTRUCTIONS

A complete list of resources needed for the instruction of this EO is located at Chapter 4 of the QSP. Specific uses for said stores are identified throughout the Instructional Guide, within the teaching point for which they are required.

Prior to instructing this lesson the instructor shall:

- review the lesson content, and become familiar with the material;
- ensure ironing boards, irons, pressing cloth, boot polish, boot cloths, old toothbrushes, lint brushes, hair supplies such as elastics and hair spray, and any other items that may be needed are available for this lesson;
- ensure a copy of EO M107.05 (Section 5) is available for reference purposes during this lesson; and
- inform the cadets that they are to bring the parts of their uniforms with them for this lesson.

PRE-LESSON ASSIGNMENT

Prior to the lesson the cadet shall gather their uniform parts to bring with them for this lesson.

APPROACH

The demonstration method was also chosen due to the practical nature of caring for a uniform. This method provides the instructor the opportunity to introduce the subject matter and demonstrate procedures. The demonstration method must always be used when the taxonomic level of the material requires a performance of a skill. This method is highly developmentally appropriate for young cadets.

The small group activity was selected to allow for maximum participation in the learning process. It is an interactive way to illustrate and substantiate the lesson material in a concrete manner.

REVIEW

N/A.

OBJECTIVES

By the end of this lesson the cadet shall be expected to be able to maintain the air cadet uniform.

IMPORTANCE

The cadet uniform is highly recognizable and the standard of personal dress, appearance and grooming shall be such as to reflect credit on the individual and on the Canadian Cadet Organization (CCO).

Teaching Point 1

Explain the Pressing Cloth

Time: 2 min

Method: Interactive Lecture

THE PRESSING CLOTH

There are several points to keep in mind when ironing the uniform. A pressing cloth should always be used to prevent the parts of the uniform from becoming shiny.

Some examples of what can be used as a pressing cloth include:

- thin towel;
- pillow case;
- soft cotton cloth; and
- paper bag.

CONFIRMATION OF TEACHING POINT 1

QUESTIONS

- Q1. What is the purpose of using a pressing cloth?
- Q2. What are some items that can be used as a pressing cloth?

ANTICIPATED ANSWERS

- A1. To prevent uniform parts from becoming shiny.
- A2. Thin towel, pillow case, soft cotton cloth and paper bag.

Teaching Point 2

Demonstrate the Correct Method of Care for the Trousers

Time: 4 min

Method: Demonstration

TROUSERS

The instructor shall demonstrate the correct method of care for the trousers to include:

- ensuring trousers are well pressed and free of dirt and lint at all times; and
- pressing the trousers, in accordance with the standard outlined in EO M107.05 (Section 5), which is achieved by:
 - lining the pant leg up by the seams to ensure the creases are properly positioned at the centre of the front and back of the leg;
 - laying the pant leg flat on the ironing board;
 - spraying the pants with water from a water bottle;

- placing a pressing cloth over the pant leg;
- ironing the pants until a sharp crease extends down the centre of each leg in the front and back, from the top of the leg to the bottom; and
- ironing on the same crease each time in order to avoid double creases.

Teaching Point 3**Demonstrate the Correct Method of Care for the Short Sleeve Shirt**

Time: 4 min

Method: Demonstration

SHORT SLEEVE SHIRT

The instructor shall demonstrate the correct method of care for the short sleeve shirt to include:

- ensuring the short sleeve shirt is clean; and
- pressing the short sleeve shirt, in accordance with the standard outlined in EO M107.05 (Section 5), which is achieved by:
 - pressing the entire short sleeve shirt to ensure it is free of wrinkles by laying it flat on the ironing board;
 - pressing the sleeves flat with the top of the sleeve laid flat to ensure a sharp crease is formed down the centre of each sleeve starting at the centre of each epaulette. There should only be one crease in each sleeve; and
 - the collar may be starched to prevent it from becoming limp.

Teaching Point 4**Demonstrate the Correct Method of Care for the Jacket**

Time: 4 min

Method: Demonstration

JACKET

The instructor shall demonstrate the correct method of care for the jacket to include:

- ensuring the jacket is clean; and
- pressing the jacket, in accordance with the standard outlined in EO M107.05 (Section 5), which is achieved by:
 - pressing the front and back of the jacket to ensure it is free of wrinkles;
 - ensuring the pockets on the front of the jacket are pressed flat; and
 - ensuring the sleeves of the jacket are roll pressed so they are free of creases by ironing the sleeves in sections but not ironing the edges.

Teaching Point 5**Demonstrate General Guidelines for Care of the Boots**

Time: 5 min

Method: Demonstration

BOOTS

The instructor shall demonstrate caring for the boots to include:

- polishing, in accordance with the general guidelines outlined in EO M107.05 (Section 5), which is achieved by:
 - cleaning the welts of the boot with an old toothbrush and black boot polish;
 - using a polish cloth wrapped around the index finger;
 - applying a moderate amount of polish to the cloth;
 - applying the polish in a circular motion to the area being polished;
 - starting with large circles to cover the area with polish;
 - using smaller circles as the polish gets worked into the boot;
 - continuing to work in a circular motion until circles formed by the polish are no longer visible; and
 - the whole boot is to be polished, not just the toe;
- lacing the boots, which is achieved by:
 - lacing them straight across;
 - tucking the laces inside the boots; and
 - boots should not be tied too tightly.

Teaching Point 6**Demonstrate the Correct Method for Wearing the Hair**

Time: 4 min

Method: Demonstration

HAIRSTYLES

The instructor shall demonstrate hairstyles in accordance with EO M107.05 (Section 5), which is achieved by ensuring:

- hair is neatly groomed and conservatively styled;
- the wearing of the wedge is not precluded by the length, bulk and style of the hair;
- the style and colour is not bizarre, exaggerated or of unusual appearance;
- the hair is secured or styled back to reveal the face. Any accessories used to secure or control hairstyles shall be unobtrusive;
- that male cadets' hair is taper trimmed at the back, sides and above the ears to blend with the hairstyle;
- the hair is not touching the ears or falling below the top of the eyebrows when the wedge is removed;
- that sideburns are not extending below a line horizontally bisecting the ear, are not squared off horizontally at the bottom edge, and are taper trimmed to conform to the overall hairstyle;
- that female cadets' hair is not extending below the lower edge of the shirt collar;
- that braids are styled conservatively, tied tightly, and secured at the end by a knot or a small unadorned fastener;
- a single braid is worn in the centre of the back; and
- that double braids are worn behind the shoulders.



Further information supporting hairstyles can be found in EO M107.05 (Section 5).

Teaching Point 7

Conduct an Activity on Maintaining the Uniform and Hair

Time: 30 min

Method: Activity

ACTIVITY – “MAN YOUR STATIONS”

Time: 30 min

OBJECTIVE

The objective of this activity is to have the cadets demonstrate care and maintenance of the Air Cadet uniform.

RESOURCES

- Uniform pieces presented in the lesson.
- Irons.
- Ironing boards/tables.
- Pressing cloths.
- Water bottle.
- Black boot polish.
- Soft boot cloth.
- Old toothbrush.
- Hair elastics.
- Hair nets.
- Bobby pins.
- Hair spray.
- Scissors.
- Assistants if available.

ACTIVITY LAYOUT

- Divide class into five groups.
- Groups will be assigned a station to start at:
 - Station 1: Maintain the trousers;
 - Station 2: Maintain the short sleeve shirt;

- Station 3: Maintain the jacket;
- Station 4: Maintain the boots; and
- Station 5: Correct wear of the hair.
- Each group will rotate through each of the stations for a specified amount of time, approximately five minutes at each.
- The cadets are to maintain the parts of the uniform at each station, with the assistance of senior cadets or officers, if available.

SAFETY

Cadets must be carefully supervised while using hot irons.

INSTRUCTOR GUIDELINES

- During the activity supervise and praise the cadets as they maintain each part of the uniform.
- Assistant instructors should be made available to help supervise at the stations.
- If only the instructor is available, they are to rotate around the stations to supervise all cadets.
- Signal timings for station rotations.
- If cadets do not have uniform parts, ensure extra parts are available for the cadets to use.

END OF LESSON CONFIRMATION

The end of lesson confirmation consists of the instructor inspecting the cadets' uniforms to ensure they meet the standard outlined in EO M107.05 (Section 5).

CONCLUSION

HOMEWORK/READING/PRACTICE

N/A.

METHOD OF EVALUATION

There is no formal assessment of this EO. Cadets will be assessed on a continuous basis during parade night routines and through uniform inspections at the squadron.

CLOSING STATEMENT

The Air Cadet uniform should be worn properly at all times. The cadet uniform is highly recognizable and the standard of personal dress, appearance and grooming shall be such as to reflect credit on the individual and the CCO. The intent is to ensure a high standard of grooming consistent with that expected of cadets.

INSTRUCTOR NOTES/REMARKS

Emphasis must be placed on the cadets' requirement to care for and maintain their uniforms at all times. Cadets should learn from the beginning how to maintain their uniforms and wear them properly.

This lesson should be delivered at the beginning of the training year before the cadets are expected to wear their uniforms.

REFERENCES

- A0-001 A-AD-265-000/AG-001, DHH 3-2. (2001). *Canadian Forces Dress Instructions*. Ottawa, ON.
- A3-006 Cadets Canada. (2005). CATO 55-04, *Royal Canadian Air Cadet Dress Instructions*. In *Cadet Administrative and Training Orders (Vol. 5)*. Ottawa, ON.

THIS PAGE INTENTIONALLY LEFT BLANK



ROYAL CANADIAN AIR CADETS

LEVEL ONE

INSTRUCTIONAL GUIDE



SECTION 8

EO C107.02 – IDENTIFY THE AIR FORCE NCM RANK STRUCTURE OF THE CF

Total Time:

30 min

INTRODUCTION

PRE-LESSON INSTRUCTIONS

A complete list of resources needed for the instruction of this EO is located at Chapter 2 of the QSP. Specific uses for said stores are identified throughout the Instructional Guide, within the teaching point for which they are required.

Prior to instructing this lesson the instructor shall:

- review the lesson content, and become familiar with the material; and
- gather Non-Commissioned Member (NCM) rank badges or large pictures of each rank.

PRE-LESSON ASSIGNMENT

N/A.

APPROACH

The interactive lecture method was chosen as it allows the instructor to make a semi-formal presentation of the material where the cadets can participate by asking or responding to questions and commenting on the material. For this lesson, this method is most effective as it matches well the taxonomic level of the material and is age-appropriate by virtue of its participatory nature.

The small group activity was selected to allow for maximum participation in the learning process. It is an interactive way to illustrate and substantiate the lesson material in a concrete manner.

REVIEW

N/A.

OBJECTIVES

By the end of this lesson the cadet shall identify the NCM rank structure of the air element of the Canadian Forces.

IMPORTANCE

Cadets will often come in contact with personnel from the Canadian Forces. It is important that they be able to use proper marks of respect.

Teaching Point 1

Describe the NCM Rank Structure of the Air Element of the Canadian Forces

Time: 10 min

Method: Interactive Lecture

AIR FORCE NCM RANK STRUTURE

The NCM rank structure for the air element of the Canadian Forces (CF) is as follows:

- **Private Recruit (Pte R).** The Private Recruit rank has no rank badge.



www.forces.gc.ca/site/community/insignia/aira_e.asp#noncommisionned

Figure 7-8-1 Private Recruit Rank

- **Private (Pte).** The Private rank consists of one chevron.



www.forces.gc.ca/site/community/insignia/aira_e.asp#noncommisionned

Figure 7-8-2 Private Rank

- **Corporal (Cpl).** The Corporal rank consists of two chevrons.



www.forces.gc.ca/site/community/insignia/aira_e.asp#noncommisionned

Figure 7-8-3 Corporal Rank

- **Master Corporal (MCpl).** The Master Corporal rank consists of two chevrons with a maple leaf on top.



www.forces.gc.ca/site/community/insignia/aira_e.asp#noncommisionned

Figure 7-8-4 Master Corporal Rank

- **Sergeant (Sgt).** The Sergeant rank consists of three chevrons with a maple leaf on top.



www.forces.gc.ca/site/community/insignia/aira_e.asp#noncommisionned

Figure 7-8-5 Sergeant Rank

- **Warrant Officer (WO).** The Warrant Officer rank consists of a Tudor crown.



www.forces.gc.ca/site/community/insignia/aira_e.asp#noncommisionned

Figure 7-8-6 Warrant Officer Rank

- **Master Warrant Officer (MWO).** The Master Warrant Officer rank consists of a Tudor crown surrounded by a wreath.



www.forces.gc.ca/site/community/insignia/aira_e.asp#noncommisionned

Figure 7-8-7 Master Warrant Officer Rank

- **Chief Warrant Officer (CWO).** The Chief Warrant Officer rank consists of the Canadian Coat of Arms.



www.forces.gc.ca/site/community/insignia/aira_e.asp#noncommisionned

Figure 7-8-8 Chief Warrant Officer Rank



The cadets should be able to identify the ranks from the badges or from pictures of the badges. The cadets should also be able to put the ranks in the proper sequence.

CONFIRMATION OF TEACHING POINT 1

QUESTIONS

- Q1. Which rank comes after Master Corporal?
- Q2. Which rank is identified by the Canadian Coat of Arms?
- Q3. How many chevrons identify the Corporal rank?

ANTICIPATED ANSWERS

- A1. Sergeant.
- A2. Chief Warrant Officer.
- A3. Two.

Teaching Point 2

Conduct a NCM Rank Structure Identity Activity

Time: 12 min

Method: Activity

ACTIVITY

Time: 12 min

OBJECTIVE

The objective of this activity is for cadets to become familiar with the NCM rank structure of the air element of the CF.

RESOURCES

- Paper copies of ranks found in Annex E (use as many ranks as the number of cadets in the class; if there are more than eight cadets there can be more than one cadet with the same rank).
- Tape.

ACTIVITY LAYOUT

- Ranks are taped to the back of each cadet (the cadet does not get to see the rank that is on their back).
- The cadets have to walk around and ask other cadets yes or no questions to determine what rank they are wearing. For example, "Do I have two chevrons?" The cadet has to determine from the answers to their questions what rank they are.
- The cadets can only ask one question to each of the other cadets. They cannot ask the same cadet more than one question to determine what rank they are. This will ensure the cadets are interacting fully with the other members of the class.
- Once cadets have determined what rank they think they are, they will form a group with any other cadets who are the same rank, if there are any.
- After 10 minutes, the cadets split into their rank groups. They will then present what rank they think they are based on the information they received. For example, if a group has determined they have only two chevrons on their back, they would present themselves as the Corporal group/individual.

SAFETY

Ensure there is an open area in the classroom that the cadets can easily walk around in.

INSTRUCTOR GUIDELINES

- Ensure that the cadets have a full understanding of how to ask the right questions before starting the activity to determine what rank they are.
- Ensure that cadets do not take their ranks off to look at them.

END OF LESSON CONFIRMATION

Cadets should be able to identify the ranks as the instructor holds them up.

CONCLUSION

HOMEWORK/READING/PRACTICE

N/A.

METHOD OF EVALUATION

There is no formal assessment of this EO.

CLOSING STATEMENT

Cadets should be able to identify the NCM ranks of the air element of the CF in required situations.

INSTRUCTOR NOTES/REMARKS

N/A.

REFERENCES

- A3-005 QR&O 3.01 Department of National Defence. (2006). QR&O 3.01, *Ranks and Designations of Rank*. In Queen's Regulations and Orders for the Canadian Forces (Vol. 1, Chapter 3), Ottawa, ON.
- A3-008 Department of National Defence. Retrieved 6 April 2006, from www.forces.gc.ca/site/Community/insignia/aira_e.asp#commisioned.

THIS PAGE INTENTIONALLY LEFT BLANK



COMMON TRAINING INSTRUCTIONAL GUIDE



SECTION 9

EO C107.03 – TOUR THE SQUADRON

Total Time:

30 min

INTRODUCTION

PRE-LESSON INSTRUCTIONS

A complete list of resources needed for the instruction of this EO is located at Chapter 2 of the QSP. Specific uses for said stores are identified throughout the Instructional Guide within the teaching point for which they are required.

Prior to instructing this lesson the instructor shall:

- review the lesson content and become familiar with the material;
- coordinate tour with all squadron departments;
- review squadron protocols for offices, parade square, classrooms, break areas, out of bounds areas and saluting zones;
- arrange for one tour guide for every four cadets (can be senior cadets, officers, civilian instructors, or volunteers that are familiar with the squadron facilities);
- prepare maps (one for every four cadets) of the squadron facilities with numbered points of interest (see example in Annex F);
- prepare squadron passports (one for each cadet). See example in Annex G; and
- set up sticker stations at each point of interest.

PRE-LESSON ASSIGNMENT

N/A.

APPROACH

The small group activity was selected to allow for maximum participation in the learning process. It is an interactive way to illustrate and substantiate the lesson material in a concrete manner.

The group discussion method was chosen to allow the cadets to share their knowledge, opinions, and feelings about the subject matter while still allowing the instructor to control the direction of the discussion. The instructor must ensure that points not brought forth by the class are presented. If the instructor follows the Instructional Guide, including the questions posed, this will allow the cadets to express, in their own words, what they learned from this lesson and how they may apply the information.

REVIEW

The pertinent review for this lesson will include:

- officer ranks (TP2 of EO M107.02 [Section 2]); and
- regulations for paying compliments inside a building (TP3 of EO M107.03 [Section 3]).

OBJECTIVES

By the end of this lesson the cadet shall be expected to:

- identify the location of:
 - the parade square;
 - classrooms;
 - break areas;
 - canteen;
 - washrooms;
 - communication areas;
 - Commanding Officer's (CO's) office;
 - administration office;
 - training office;
 - supply office; and
 - out of bounds areas; and
- observe appropriate protocols associated with each location.

IMPORTANCE

Being familiar with the location of all the squadron facilities can aid the cadets in following instructions, finding information and participating in squadron activities.

BACKGROUND KNOWLEDGE



This information is representative only. Information presented must be tailored to be specific to the squadron. Individual squadron may have information that will vary from the information given in this guide.

PARADE SQUARE

The parade square is where cadets have parades. It is where inspections and drill classes usually take place and where the squadron holds parades and other ceremonial events. Appropriate squadron protocols should be followed regarding the parade square.

CLASSROOMS

Classrooms are the areas where cadets participate in most of their training. The classroom space must be respected, especially in facilities that are shared with other groups. Anything that does not belong to the squadron should be left alone. Protocol for entering and leaving the classroom should be followed.

BREAK AREAS

Break areas are where the cadets should be when not tasked. The squadron guidelines for the use of the area should be discussed.

CANTEEN

The canteen is a store for snacks and other items. The money raised through the canteen may be used to benefit the squadron. Hours of operation, personnel responsible and how the money is used should be discussed.

WASHROOMS

The location of the facilities should be pointed out.

COMMUNICATIONS AREAS

Communications areas could include bulletin boards, activity sign-up sheets, and the location of the standing orders and routine orders. The standing orders contain squadron policies. The routine orders contain information on duties, events, activities and personnel changes. Authorization to post information should be discussed.

COMMANDING OFFICER'S OFFICE

If the CO is available, they should introduce themselves and state briefly what they do. If the CO is not available, the tour guide will provide this information. The CO is at the top of the chain of command within the squadron. The CO is responsible for the training and administration of the cadets, civilian instructors and officers working with the squadron. Cadets will normally only visit the CO's office at the CO's request, or if directed by another officer. Protocol for entering and leaving an office should be reviewed.

ADMINISTRATION OFFICE

If the administration staff is available, they should introduce themselves and state very briefly what they do. If they are not available, the tour guide will provide this information. The Administration Officer (Admin O) is responsible for handling the administrative duties. They are responsible for ensuring forms such as cadet enrolments and summer training applications are completed in full and returned in a timely fashion. They could also be responsible for ensuring attendance is taken for all squadron activities. Other administrative staff may include assistant administration officers. Cadets may need to go to the administration office to complete paperwork, report absences or to pick up forms. Protocol for entering and leaving an office should be reviewed.

TRAINING OFFICE

If the training staff is available, they should introduce themselves and state very briefly what they do. If they are not available, the tour guide will provide this information. The Training Officer (Trg O) is responsible for the coordination and implementation of the squadron training program. They are responsible to ensure that training is planned in a logical fashion, instructors are prepared for classes and training materials are readily available for classes. They are also responsible for any administrative forms that are directly related to training, such as training records. Other training staff could include an assistant Trg O, standards officer and level Trg Os. Cadets will normally only visit the training office if the training officer has requested them, or they have been directed by another staff member or cadet NCO. Protocol for entering and leaving an office should be reviewed if applicable.

SUPPLY OFFICE

If the supply staff is available, they should introduce themselves and state very briefly what they do. If they are not available, the tour guide will provide this information. The Supply Officer (Sup O) is responsible for ordering uniform parts, issuing uniforms parts as necessary and distributing other equipment. They are responsible for all administrative forms that are directly related to supply. Other supply staff could include assistant Sup Os. Cadets will normally visit the supply office to receive their uniform and to exchange items that no longer fit or have become damaged. Appointments may be necessary. If the supply section has specific hours when it is open to cadets, these hours should be stated. Protocol for entering and leaving an office should be reviewed, if applicable.

OUT OF BOUNDS AREAS

Any areas that are out of bounds to cadets should be pointed out. The consequences for violating this policy should be explained.

ACTIVITY

Time: 20 min

OBJECTIVE

This activity is designed to familiarize the cadet with the facilities and staff of their squadron.

RESOURCES

- squadron maps with numbered points of interest, if available (an example map is provided in Annex F).
- squadron passports.
- Stickers.

ACTIVITY LAYOUT

1. Divide the cadets into groups of four and assign each group a tour guide. Each cadet will receive a passport, found in Annex G, to be completed during the tour.



Group size may be adjusted based on the number of available tour guides and the number of cadets in the class.

2. Give each group a map and assign a starting point of interest. Starting points should be separated by one point if possible, to avoid more than one group at any one point during the tour.
3. Each group shall progress through the tour by visiting the points of interest. Tour guides will present the appropriate information at each point. Only one to two minutes should be necessary at each stop.
4. Each cadet shall answer the questions for each point of interest on their squadron passports. The tour guide will check the answers at each point and award stickers to complete the passport.

SAFETY

N/A.

INSTRUCTOR GUIDELINES

- Brief the tour guides on activity layout and their role.
- Circulate throughout the squadron facilities to watch for bottlenecks and move groups along as necessary.
- Answer questions.
- Ensure protocols are being observed.

REFLECTION

Time: 5 min

Method: Group Discussion

GROUP DISCUSSION



Instructors shall ensure that all lesson objectives are drawn out towards the end of the reflection stage.

DISCUSSION QUESTIONS



TIPS FOR ANSWERING/FACILITATING DISCUSSION

- Ask questions that help facilitate discussion; in other words, avoid questions with yes or no answers.
- Prepare questions ahead of time.
- Be flexible (you are not bound to only the prepared questions).
- Encourage cadets to participate by using praise such as “great idea” or “excellent response, can anyone add to that?”.
- Try to involve everyone by directing questions to non-participants.

SUGGESTED QUESTIONS

- Q1. Why is it important to know where all of the squadron facilities are located?
- Q2. How do you feel now that you know where everything is located?
- Q3. What other information about the squadron facilities would help you feel more comfortable at cadets?

CONCLUSION

HOMEWORK/READING/PRACTICE

N/A.

METHOD OF EVALUATION

There is no formal assessment of this EO.

CLOSING STATEMENT

Knowing the location of all the squadron facilities will assist cadets in following instructions, finding information and participating effectively in squadron activities.

INSTRUCTOR NOTES/REMARKS

N/A.

REFERENCES

N/A.



COMMON TRAINING INSTRUCTIONAL GUIDE



SECTION 10

EO C107.04 – PARTICIPATE IN AN ACTIVITY ABOUT THE HISTORY OF THE SQUADRON

Total Time:

60 min

INTRODUCTION

PRE-LESSON INSTRUCTIONS

A complete list of resources needed for the instruction of this EO is located at Chapter 2 of the QSP. Specific uses for said stores are identified throughout the Instructional Guide, within the teaching point for which they are required.

Prior to instructing this lesson the instructor shall:

- familiarize themselves with the history of their squadron ensuring that the information they have researched covers all of the objectives of the lesson;
- obtain any memorabilia that would support the lessons content (e.g. historical documents photos, videos, awards, etc.); and
- set up learning stations in the classroom, and have cards prepared (see Activity Section below).

PRE-LESSON ASSIGNMENT

N/A.

APPROACH

The small group activity was selected to allow for maximum participation in the learning process. It is an interactive way to illustrate and substantiate the lesson material in a concrete manner.

The group discussion method was chosen to allow the cadets to share their knowledge, opinions, and feelings about the subject matter while still allowing the instructor to control the direction of the discussion. The instructor must ensure that points not brought forth by the class are presented. If the instructor follows the Instructional Guide, including the questions posed, this will allow the cadets to express, in their own words, what they learned from this lesson and how they may apply the information.

REVIEW

N/A.

OBJECTIVES

By the end of this lesson the cadet shall be expected to be familiar with:

- the formation of their squadron;

- significant squadron developments since inception; and
- awards and accomplishments of the squadron.

IMPORTANCE

The history of a squadron is a source of pride for those within it. Understanding the history of the squadron allows the cadet to see what has shaped the unit since its inception and recognize the progress it has made in numerous areas.

BACKGROUND KNOWLEDGE

SQUADRON FORMATION

There are a number of events that are historically important during the creation of a squadron. These include:

- the charter date for the squadron;
- the initial composition of the squadron, staff and cadets; and
- the first sponsor of the squadron.

SQUADRON DEVELOPMENTS

Squadrons participate in a number of community service events. Some events may happen annually, while others may occur only during special occasions. These events include, but are not limited to:

- ceremonial parades;
- fundraising events for charities; and
- civic events.

Also, squadron personnel are involved in a number of activities within their unit, which are an important part of the unit's history. These activities may include, but are not limited to:

- formation of various activities within the squadron (such as a drill team, band, first aid team, marksmanship team, etc.);
- participation in exchanges; and
- squadron trips to various locations.

Other important developments in the history of a squadron include:

- the development of a squadron crest; and
- the affiliation of a squadron with a Canadian Forces (CF) military unit.

SQUADRON AWARDS AND ACCOMPLISHMENTS

There are a number of ways that a squadron can be recognized. The recognition may come from winning a competition, or for demonstrating excellence in a particular area. These awards can be won on provincial, regional, national, and in some circumstances, international levels.

Many opportunities exist for cadets to win awards at all levels of the Canadian Cadet Organization (CCO). Cadets winning such awards reflect well upon the squadron.

Memorial awards are awards that are left in memory of someone that has made significant contributions to the local squadron or the CCO. Memorial awards that may be given are an important source of historical information within the squadron.

Outside of awards, there are a number of other cadet accomplishments that make up a fundamental part of the squadron history. They include, but are not limited to:

- civilian careers of former cadets; and
- military careers of former cadets.

ACTIVITY

Time: 40 min

OBJECTIVE

The objective of this activity is to familiarize the cadets with the history of their squadron.

RESOURCES

- squadron photographs.
- squadron video.
- squadron awards.
- Flipchart paper.
- Flipchart markers.
- Construction paper.
- Three tables.
- Bristol board.

ACTIVITY LAYOUT

Before the activity:

- Prepare learning stations based on three topic areas as found in Annex H:
 - squadron formation;
 - squadron developments; and
 - squadron accomplishments.
- Identify each station by a colour.
- Ensure each learning station is dynamic by using photos, newspaper clippings, video clips, timelines, memorabilia, summaries on bristol board or other items.
- Prepare four cadet research cards for each learning station.
- Each research card will be a different colour to correspond to the learning station of the same colour.
- These cards will have a key word written on them to indicate what the cadet is to research.

During the activity, the cadets will be:

- divided into groups of four with a maximum of six groups. If there are more than 16 cadets, make the groups larger. There can be more than one group at a learning station at a time;
- given several research cards that correspond to each of the three learning stations;
- given 8 minutes to research information; and
- given 7 minutes to prepare their researched information on flipchart paper.

SAFETY

N/A.

INSTRUCTOR GUIDELINES

During the activity the instructor shall ensure the cadets are collecting their information, and moving between learning stations in a timely manner.

REFLECTION

Time: 10 min

Method: Group Discussion

GROUP DISCUSSION



Once the activity is completed, the instructor shall have the groups come up to present their information to the class. The instructor shall call up groups with respect to the topic order listed in background information. The instructor should ensure they highlight any missed information after each topic has been presented.

DISCUSSION QUESTIONS



- During this stage the instructor should quickly pose some questions to the class to confirm their understanding of the knowledge presented in the lesson.
- Some of the questions below may not have been directly answered through the learning station. It is the responsibility of the instructor to create a brief discussion around these questions, emphasizing important points brought forth by the cadets.

SUGGESTED QUESTIONS

- Q1. Why is it important for members of the squadron to be familiar with how it was formed?
- Q2. Why are memorial awards important to the history of a squadron?
- Q3. Why is it important for cadets to understand the history of the corps'/squadrons' involvement within their community?
- Q4. What role do activities such as drill team, band, first aid, etc. play in developing a squadron?

CONCLUSION

REVIEW

Upon completion of the group discussion the instructor will conclude by summarizing to ensure that all teaching points have been covered. The instructor must also take this opportunity to explain how the cadet will apply this knowledge in the future.

MAIN TEACHING POINTS

- TP1. Discuss the formation of the squadron.
- TP2. Discuss significant squadron developments since its inception.
- TP3. Discuss awards and accomplishments of the squadron.

HOMEWORK/READING/PRACTICE

N/A.

METHOD OF EVALUATION

There is no formal assessment of this EO.

CLOSING STATEMENT

Being familiar with the history of the squadron will give cadets a reason to take pride in being a part of it. Having a good understanding of this information can give cadets more of an appreciation of the squadron and allow them to pass this information on to others.

INSTRUCTOR NOTES/REMARKS







N/A.

REFERENCES

N/A.

















THIS PAGE INTENTIONALLY LEFT BLANK

AIR CADET RANKS

<p>NO BADGE</p>	
	
	
	

THIS PAGE INTENTIONALLY LEFT BLANK

AIR OFFICER RANKS

THIS PAGE INTENTIONALLY LEFT BLANK

PUZZLES

THE MISSION OF THE CADET PROGRAM IS TO CONTRIBUTE TO THE DEVELOPMENT AND PREPARATION OF YOUTH FOR THE TRANSITION TO ADULTHOOD, ENABLING THEM TO MEET THE CHALLENGES OF MODERN SOCIETY, THROUGH A DYNAMIC, COMMUNITY-BASED PROGRAM.

**A RELEVANT, CREDIBLE
AND PROACTIVE YOUTH
DEVELOPMENT ORGANIZATION,
OFFERING THE PROGRAM OF
CHOICE FOR CANADA'S YOUTH,
PREPARING THEM TO BECOME
THE LEADERS OF TOMORROW
THROUGH A SET OF FUN,
CHALLENGING, WELL-ORGANIZED
AND SAFE ACTIVITIES.**

**DEVELOP IN YOUTH THE
ATTRIBUTES OF GOOD
CITIZENSHIP AND LEADERSHIP.**

PROMOTE PHYSICAL FITNESS.

**STIMULATE THE INTEREST OF
YOUTH IN THE SEA, LAND AND
AIR ACTIVITIES OF THE
CANADIAN FORCES.**

**TO LEARN
TO SERVE
TO ADVANCE**

RECOGNIZE YOUR UNIFORM ACTIVITY

WEDGE	LIGHT BLUE COTTON T-SHIRT	BLACK GLOVES AND MITTS	RUNNING SHOES
WEDGE INSIGNIA	TURTLE-NECK SWEATER	NAMETAG	GREY WOOL SOCKS
WIDE BRIMMED TAN SUMMER HAT	JACKET AND JACKET BELT	TROUSERS	SQUADRON SHOULDER BADGE
TOQUE	ALL-SEASON JACKET	BLACK BELT	LAC RANK BADGE
SHORT SLEEVE SHIRT	RANK SLIP-ONS	GREY SPORTS SHORTS	
NECKTIE	GREY SPORTS T-SHIRT	BOOTS	

THIS PAGE INTENTIONALLY LEFT BLANK

NON-COMMISSIONED MEMBER (NCM) RANKS OF THE AIR ELEMENT OF THE CANADIAN FORCES

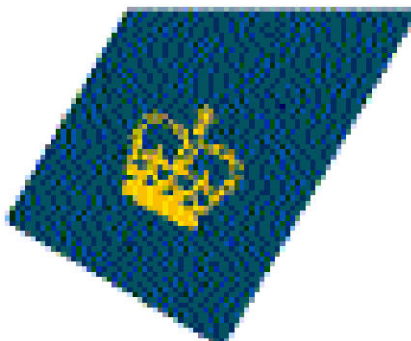
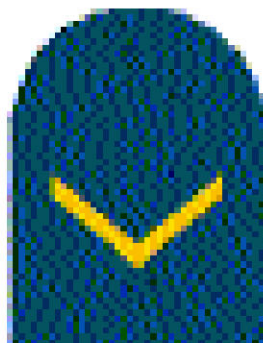
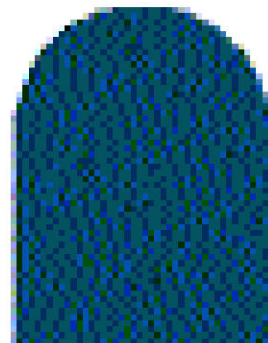
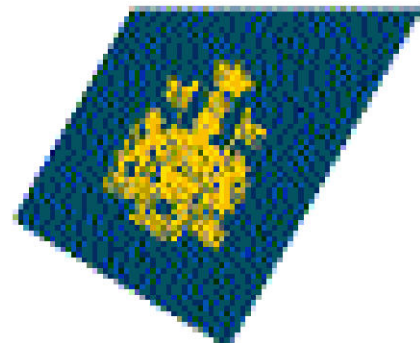

THIS PAGE INTENTIONALLY LEFT BLANK

EXAMPLE MAP

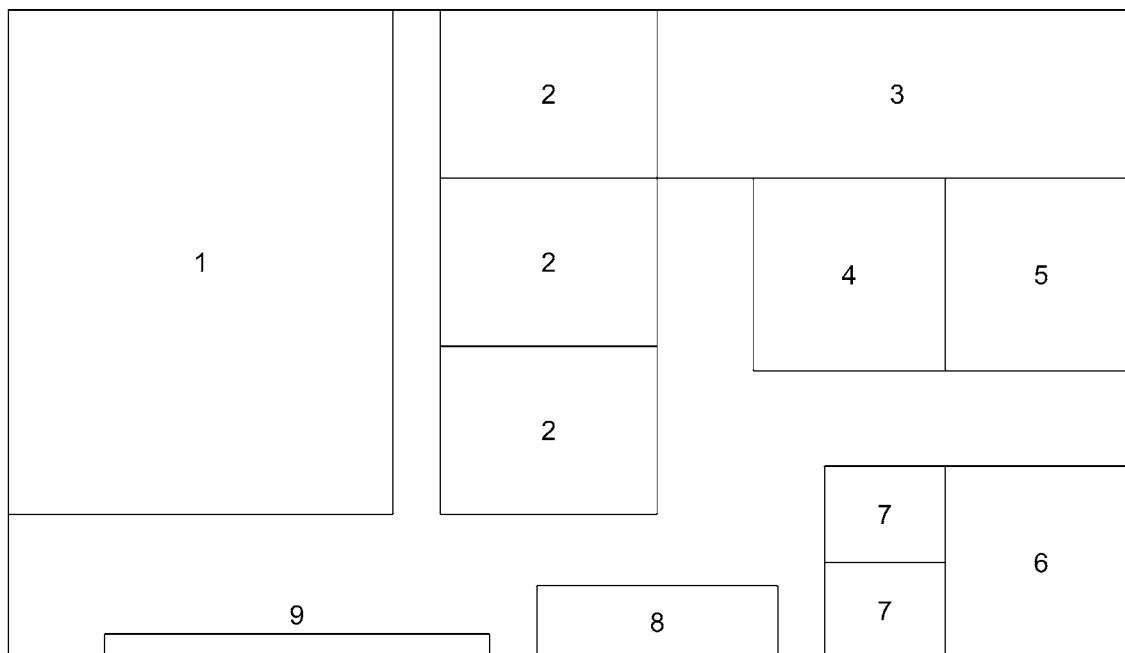

POINTS OF INTEREST:

1. Parade Square
2. Classrooms
3. Supply Office/Stores
4. Administration Office
5. Training Office
6. Commanding Officer's Office
7. Washrooms
8. Canteen
9. Communications Area

THIS PAGE INTENTIONALLY LEFT BLANK

SQUADRON PASSPORT

<p>THE PARADE SQUARE</p> <p>What are the rules for the parade square?</p> <p>Sticker</p>	<p>CLASSROOMS</p> <p>What rooms are used for classroom training?</p> <p>Sticker</p>
<p>BREAK AREAS</p> <p>Where is the break area?</p> <p>Sticker</p>	<p>CANTEEN</p> <p>When is the canteen available?</p> <p>Sticker</p>
<p>WASHROOMS</p> <p>Where are the washrooms located?</p> <p>Sticker</p>	<p>COMMUNICATION AREAS</p> <p>Where do cadets sign up for activities?</p> <p>Who is allowed to post information?</p> <p>Sticker</p>

<p>COMMANDING OFFICER'S OFFICE</p> <p>What is the Commanding Officer's name?</p> <p style="text-align: right;">Sticker</p>	<p>ADMINISTRATION OFFICE</p> <p>What is the Administration Officer's name?</p> <p>Who else works in Administration?</p> <p style="text-align: right;">Sticker</p>
<p>TRAINING OFFICE</p> <p>What is the Training Officer's name?</p> <p>Who else works in Training?</p> <p style="text-align: right;">Sticker</p>	<p>SUPPLY OFFICE</p> <p>What is the Supply Officer's name?</p> <p>Who else works in Supply?</p> <p style="text-align: right;">Sticker</p>
<p>OUT OF BOUNDS AREAS</p> <p>Which areas are out of bounds to cadets?</p> <p style="text-align: right;">Sticker</p>	<p style="text-align: right;">Sticker</p>

MEMORIAL AWARDS

(Green Construction Paper)

Corps/Squadron Formation

CHARTER

(Red Construction Paper)

Corps/Squadron Developments

HEART AND STROKE FOUNDATION CAMPAIGN

(Blue Construction Paper)

Corps/Squadron Accomplishments

LCOLSHEA CITIZENSHIP AWARD

THIS PAGE INTENTIONALLY LEFT BLANK

CHAPTER 8

PO 108 – PARTICIPATE IN AN ANNUAL CEREMONIAL REVIEW (ACR) PARADE



COMMON TRAINING INSTRUCTIONAL GUIDE



SECTION 1

EO M108.01 – ADOPT THE POSITIONS OF ATTENTION, STAND AT EASE AND STAND EASY

Total Time:

30 min

INTRODUCTION

PRE-LESSON INSTRUCTIONS

A complete list of resources needed for the instruction of this EO is located at Chapter 2 of the QSP. Specific uses for said stores are identified throughout the Instructional Guide, within the teaching point for which they are required.

Prior to instructing this lesson the instructor shall:

- review the lesson content, and become familiar with the material; and
- select the most effective squad formation for the lesson being taught. A squad may be in a single rank, hollow square or semi-circle for elementary drill instruction. (Note: All cadets **must** be able to fully observe all demonstrations and explanations.)

PRE-LESSON ASSIGNMENT

N/A.

APPROACH

This lesson will be presented using the demonstration and performance method. The demonstration and performance method was chosen to allow cadets to participate in supervised exploration of practical instructional material. This method provides the instructor the opportunity to introduce the subject matter, demonstrate and explain procedures, and supervise the cadets while they imitate the skill. This method appeals to all learning styles.



The instructor shall develop and use a vocabulary of short, concise words to impress on the squad that the movements must be performed smartly. For example, the words “crack”, “drive”, “seize” and “grasp” suggest the degree of smartness required. Profanity or personal sarcasm shall never be used.

REVIEW

N/A.

OBJECTIVES

By the end of this lesson the cadet shall be expected to adopt the positions of attention, stand at ease and stand easy.

IMPORTANCE

As members of the Canadian Cadet Movement (CCM) cadets will be required to perform drill movements at a competent level, developing sharpness, esprit de corps, physical coordination, and alertness. These movements will be executed with ease and without hesitation. Ensuring that the cadets efficiently move together as one will promote discipline, alertness, precision, pride, steadiness, and cohesion. This develops the basis of teamwork that the CCM depends on.

Teaching Point 1

Time: 6 min

Adopting the Position of Attention

Method: Demonstration and Performance

DEMONSTRATE THE COMPLETE MOVEMENT WITH TIMING



Instructors are reminded that they are to present the example with regards to drill, from the moment they step onto the parade square. Proper drill movements, combined with a professional demeanour, are of paramount importance, and must be exemplified throughout the period of instruction.

The instructor shall provide a complete demonstration of the drill movement, with timing. A practiced assistant instructor may carry out this demonstration.

The demonstration shall be provided from various vantage points, as required.

The cadet will adopt the position of attention, by ensuring:

- a. heels are together and in line;
- b. feet are turned out to form an angle of 30°;
- c. body is balanced and weight distributed evenly on both feet;
- d. shoulders are level, square to the front;
- e. arms are hanging as straight as the natural bend will allow, with elbows and wrists touching the body;
- f. wrists are straight, the back of the hands outwards, fingers aligned, touching the palm of the hand, thumbs placed on the side of the forefinger at the middle joint with the thumbs and back of the fingers touching the thighs lightly and the thumbs in line with the seam of the trousers;
- g. head is held erect, neck touching the back of the collar, eyes steady, looking their height and straight to the front; and
- h. no part of the body is strained.

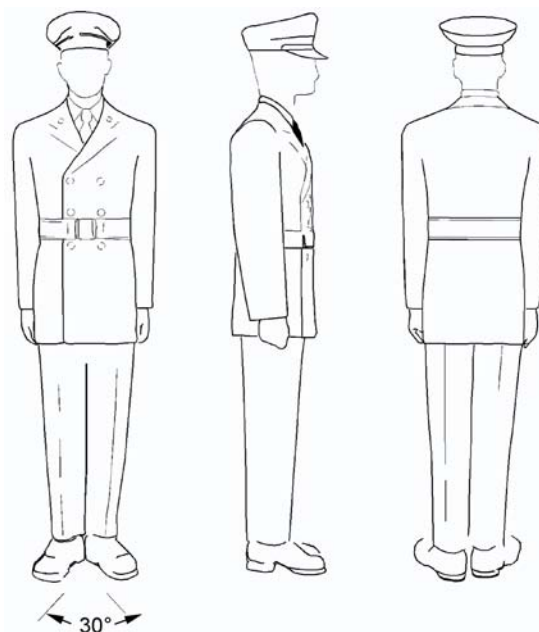

A-PD-201-000/PT-000, The Canadian Forces Manual of Drill and Ceremonial, 2001

Figure 8-1-1 The Position of Attention



A-PD-201-000/PT-000, The Canadian Forces Manual of Drill and Ceremonial, 2001

Figure 8-1-2 Fists at Position of Attention



Constant checking and correcting of all faults is essential. Faults shall be corrected immediately after they occur.

GIVE TWO COMPLETE AND FINAL DEMONSTRATIONS

The instructor(s) shall provide a full demonstration and allow time for practice.

The instructor will have the squad practice the movement collectively, individually, and collectively.

Teaching Point 2**Adopting the Position of Stand at Ease**

Time: 6 min

Method: Demonstration and Performance

DEMONSTRATE THE COMPLETE MOVEMENT WITH TIMING

The position of standing at ease is an intermediate position between attention and standing easy. It allows no relaxation, but can be maintained without strain for a longer time than the position of attention.

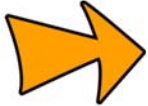
DEMONSTRATE FIRST PART OF MOVEMENT (FIRST NUMBER)

For ease of instruction, drill commands have been broken down into individual movements, or numbers. The instructor(s) shall demonstrate and explain each number.

On the command STAND AT EASE BY NUMBERS, SQUAD – ONE, the cadet shall bend the left knee.

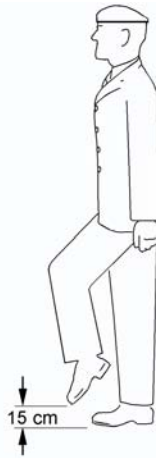

A-PD-201-000/PT-000, The Canadian Forces Manual of Drill and Ceremonial, 2001

Figure 8-1-3 Squad One – Stand at Ease

PRACTICE THE SQUAD ON THE FIRST MOVEMENT

Practice the squad on the first movement collectively, individually and collectively.



Constant checking and correcting of all faults is essential. Faults shall be corrected immediately after they occur.

DEMONSTRATE AND EXPLAIN THE SECOND PART OF THE MOVEMENT (SECOND NUMBER)

On the command SQUAD – TWO, the cadet shall:

1. carry the left foot to the left, straightening it in double time, and place it smartly flat on the ground with the inside of the heels 25 cm apart;

2. simultaneously, with a quick motion, bring the arms behind the back, stretched to their full extent, and place the back of the right hand in the palm of the left, with thumbs crossed right over left, the fingers together and extended; and
3. balance the body with the weight evenly distributed on both feet.

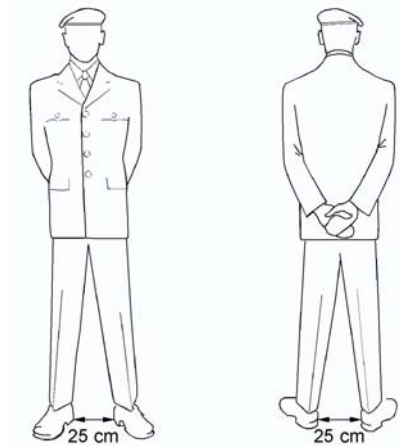

A-PD-201-000/PT-000, The Canadian Forces Manual of Drill and Ceremonial, 2001

Figure 8-1-4 The Position of Stand at Ease

PRACTICE THE SQUAD ON THE SECOND MOVEMENT

Practice the squad on the second movement collectively, individually and collectively.

GIVE TWO COMPLETE AND FINAL DEMONSTRATIONS

On the command STAND AT – EASE, combine the two movements. The timing is “one.”

The instructor(s) shall provide a full demonstration and allow time for practice.



Constant checking and correcting of all faults is essential. Faults shall be corrected immediately after they occur.

Teaching Point 3

Adopting the Position of Attention From Stand at Ease

Time: 6 min

Method: Demonstration and Performance

DEMONSTRATE THE COMPLETE MOVEMENT WITH TIMING

The instructor shall provide a complete demonstration of the drill movement, with timing. A practiced assistant instructor may carry out this demonstration.

The demonstration shall be provided from various vantage points, as required.

DEMONSTRATE FIRST PART OF MOVEMENT (FIRST NUMBER)



For ease of instruction, drill commands have been broken down into individual movements, or numbers. The instructor(s) shall demonstrate and explain each number.

In order to adopt the position of attention from stand at ease, the cadet shall:

On the command ATTENTION BY NUMBERS, SQUAD – ONE, bend the left knee and shift the balance to the right foot.

PRACTICE THE SQUAD ON THE FIRST MOVEMENT

Practice the squad on the first movement collectively, individually and collectively.

DEMONSTRATE AND EXPLAIN THE SECOND PART OF THE MOVEMENT

On the command SQUAD – TWO:

1. straighten the left leg in double time, place the foot smartly on the ground, toe touching first, followed by the heel, and with heels aligned; and
2. simultaneously, with a quick motion, bring the arms and hands to the position of attention.

GIVE TWO COMPLETE AND FINAL DEMONSTRATIONS

On the command ATTEN – TION, combine the two movements. The timing is called as “one.”

The instructor(s) shall provide a full demonstration and allow time for practice.



Constant checking and correcting of all faults is essential. Faults shall be corrected immediately after they occur.

Teaching Point 4

Adopting the Position of Stand Easy

Time: 6 min

Method: Demonstration and Performance

DEMONSTRATE THE COMPLETE MOVEMENT WITH TIMING

The instructor shall provide a complete demonstration of the drill movement, with timing. A practiced assistant instructor may carry out this demonstration.

The demonstration shall be provided from various vantage points, as required.

The position of stand easy is ordered when it is desirable to permit cadets to relax. This command is only given when the squad is in the position of stand at ease.

On the command STAND – EASY, the cadet shall:

1. close the hands and bring the arms to the position of attention; and
2. relax.

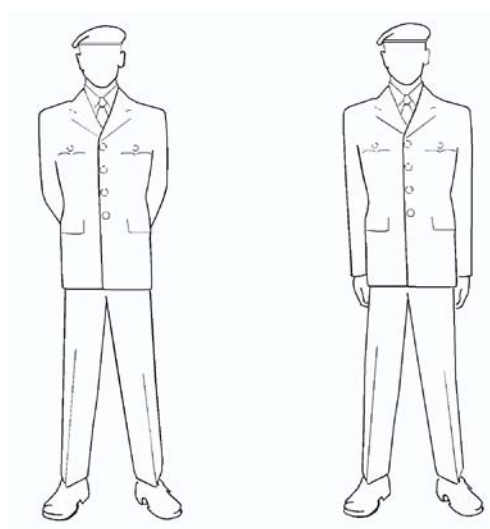

A-PD-201-000/PT-000, *The Canadian Forces Manual of Drill and Ceremonial, 2001*

Figure 8-1-5 Stand Easy From Stand at Ease



When standing easy, the cadet may, with permission, move all but the feet and adjust clothing and equipment, but shall not talk.

PRACTICE THE COMPLETE MOVEMENT WITH TIMING

Practice the squad on the first movement collectively, individually and collectively.

GIVE TWO COMPLETE AND FINAL DEMONSTRATIONS

Combine the preceding movements with timing. The instructor(s) shall provide a full demonstration and allow time for practice.

Teaching Point 5

Adopting the Position of Stand at Ease From Standing Easy

Time: 1 min

Method: Demonstration and Performance

DEMONSTRATE THE COMPLETE MOVEMENT WITH TIMING

The instructor shall provide a complete demonstration of the drill movement, with timing. A practiced assistant instructor may carry out this demonstration.

The demonstration shall be provided from various vantage points, as required.

In order to adopt the position of stand at ease from easy the cadet shall, on the cautionary command SQUAD (or formation title), assume the position of stand at ease.



This teaching point is best taught as a group practice to ensure adherence to timings and togetherness of the squad.



Constant checking and correcting of all faults is essential. Faults shall be corrected immediately after they occur.

END OF LESSON CONFIRMATION

The confirmation for this lesson should consist of the cadets, as a squad, practicing the positions of attention, stand at ease and stand easy, and should emphasize movements that cadets showed difficulty with during the class.

Practice the complete movement, with the:

- **instructor** calling the time;
- **squad** calling the time; and
- **squad judging** the time.

CONCLUSION

HOMEWORK/READING/PRACTICE

Drill movements are skills that must be practiced individually, in order to make the cadet more proficient as a member of a unit. Cadets are encouraged to practice the movements, as opportunities are made available. Ongoing feedback will be provided, and should be heeded during any drill practice.

METHOD OF EVALUATION

In accordance with A-PD-201-000/PT-000, *The Canadian Forces Manual of Drill and Ceremonial*, the cadet shall participate in an Annual Ceremonial Review (ACR) parade. This movement will be used in preparation for, and in the execution of, the ACR parade.

CLOSING STATEMENT

The hallmarks of cadet drill are efficiency, precision, and dignity. These qualities are developed through self-discipline and practice. They lead to unit pride and cohesion. Good drill that is well rehearsed, closely supervised and precise, is an exercise in obedience and alertness. It sets the standard for the execution of any duty, both for the individual and the unit, and builds a sense of confidence between commander and subordinate that is essential to high morale. The personal qualities developed on the parade ground must be maintained in all aspects of life.

INSTRUCTOR NOTES/REMARKS

N/A.

REFERENCES

- A0-002 A-PD-201-000/PT-000, DHH 3-2. (2001). *The Canadian Forces Manual of Drill and Ceremonial*. Ottawa, ON: The Department of National Defence.



COMMON TRAINING INSTRUCTIONAL GUIDE



SECTION 2

EO M108.02 – EXECUTE A SALUTE AT THE HALT WITHOUT ARMS

Total Time:

30 min

INTRODUCTION

PRE-LESSON INSTRUCTIONS

A complete list of resources needed for the instruction of this EO is located at Chapter 2 of the QSP. Specific uses for said stores are identified throughout the Instructional Guide, within the teaching point for which they are required.

Prior to instructing this lesson the instructor shall:

- review the lesson content, and become familiar with the material; and
- select the most effective squad formation for the lesson being taught. A squad may be in a single rank, hollow square or semi-circle for elementary drill instruction. (Note: All cadets **must** be able to fully observe all demonstrations and explanations.)

PRE-LESSON ASSIGNMENT

N/A.

APPROACH

This lesson will be presented using the demonstration and performance method. The demonstration and performance method was chosen to allow cadets to participate in supervised exploration of practical instructional material. This method provides the instructor the opportunity to introduce the subject matter, demonstrate and explain procedures, and supervise the cadets while they imitate the skill. This method appeals to all learning styles.



The instructor shall develop and use a vocabulary of short, concise words to impress on the squad that the movements must be performed smartly. For example, the words “crack”, “drive”, “seize” and “grasp” suggest the degree of smartness required. Profanity or personal sarcasm shall never be used.

REVIEW

The pertinent review for this lesson will include:

- EO M108.01 (Section 1).

- The instructor will have the squad adopt the positions of attention, stand at ease and stand easy. The instructor shall continue to review until the squad can perform the movements without hesitation and with ease.

OBJECTIVES

By the end of this lesson the cadet shall be expected to execute a salute at the halt without arms.

IMPORTANCE

As members of the Canadian Cadet Organization (CCO) cadets will be required to perform drill movements at a competent level, developing sharpness, esprit de corps, physical coordination, and alertness. These movements will be executed with ease and without hesitation. Ensuring that the cadets efficiently move together as one will promote discipline, alertness, precision, pride, steadiness, and cohesion. This develops the basis of teamwork that the CCO depends on.

Teaching Point 1

Execute a Salute to the Front

Time: 13 min

Method: Demonstration and Performance

DEMONSTRATE THE COMPLETE MOVEMENT WITH TIMING



Instructors are reminded that they are to present the example with regards to drill, from the moment they step onto the parade square. Proper drill movements, combined with a professional demeanour, are of paramount importance, and must be exemplified throughout the period of instruction.

The instructor shall provide a complete demonstration of the drill movement, with timing. A practiced assistant instructor may carry out this demonstration.

The demonstration shall be provided from various vantage points, as required.

The salute is given with the right hand. When physical incapacity or carrying of articles makes a salute with the right hand impracticable, compliments will be paid by turning the head and eyes to the left or right or standing to attention, as appropriate (see also A-PD-201-000/PT-000, Chapter 1, Section 2).

DEMONSTRATE FIRST PART OF MOVEMENT (FIRST NUMBER)



For ease of instruction, drill commands have been broken down into individual movements, or numbers. The instructor(s) shall demonstrate and explain each number.

On the command TO THE FRONT SALUTE BY NUMBERS, SQUAD – ONE, the cadet shall:

1. bend the right elbow and open the palm of the right hand as it passes the shoulder; and
2. force the right hand by its shortest route to the front of the headdress so that the:
 - a. palm of the hand is facing down;
 - b. thumb and fingers are fully extended and close together;
 - c. tip of the second finger is in line with the outside of the right eyebrow and touching the outside edge of the headdress or arm of glasses, if worn;

- d. hand, wrist and forearm are in a straight line and at a 45-degree angle to the upper arm;
- e. elbow is in line with the shoulders; and
- f. upper arm is parallel to the ground.

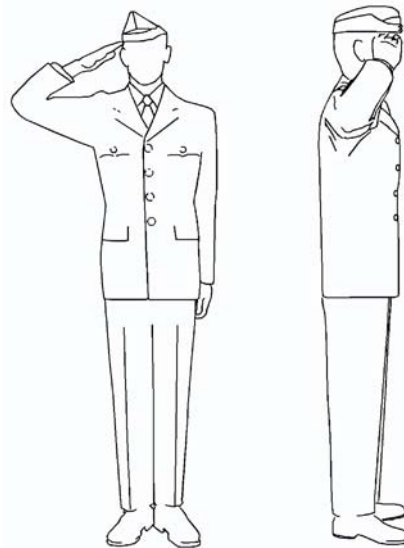

A-PD-201-000/PT-000, The Canadian Forces Manual of Drill and Ceremonial, 2001

Figure 8-2-1 Saluting to the Front Without Arms

PRACTICE THE SQUAD ON THE FIRST MOVEMENT

Practice the squad on the first movement collectively, individually and collectively.



Constant checking and correcting of all faults is essential. Faults shall be corrected immediately after they occur.

DEMONSTRATE AND EXPLAIN THE SECOND PART OF THE MOVEMENT

On the command SQUAD – TWO, the hand is:

1. brought sharply to the position of attention by the shortest route, without slapping the thigh; and
2. closed after the forearm is lowered below shoulder level.

PRACTICE THE SQUAD ON THE SECOND MOVEMENT

Practice the squad on the second movement collectively, individually and collectively.

GIVE TWO COMPLETE AND FINAL DEMONSTRATIONS

On the command TO THE FRONT – SALUTE, the two movements are combined. The standard pause shall be observed between movements.

The instructor(s) shall provide a full demonstration and allow time for practice.

Note: When wearing headdress, other than a cap with a peak, the second finger is 2 cm above and in line with the outer tip of the right eyebrow.



Standard Pause: The standard pause between each movement is two beats in quick time. For example, on the command MOVE TO THE RIGHT IN FILE, RIGHT – TURN, the squad:

1. executes the first movement of the turn on the executive order and simultaneously calls out “ONE”;
2. after completing the first movement, calls “TWO”, “THREE” while observing the standard pause; and
3. when executing the final movement, calls out “ONE”.

Teaching Point 2

Execute a Salute to the Right (Left)

Time: 12 min

Method: Demonstration and Performance

DEMONSTRATE THE COMPLETE MOVEMENT WITH TIMING

The instructor shall provide a complete demonstration of the drill movement, with timing. A practiced assistant instructor may carry out this demonstration.

The demonstration shall be provided from various vantage points, as required.

DEMONSTRATE FIRST PART OF MOVEMENT (FIRST NUMBER)

Salutes may also be carried out to the right (left), in that:

On the command TO THE RIGHT (LEFT) SALUTE BY NUMBERS, SQUAD – ONE, saluting shall be executed as detailed in TP1, except that the head and eyes shall be turned smartly to the right (left) as far as possible without straining, remembering that:

1. when saluting to the left, the right hand, wrist and arm are brought further over to the left to the correct position in line with the outside edge of the right eyebrow; and
2. when saluting to the right, the arm is moved to the rear, with the tip of the second finger remaining in line with the outside edge of the right eyebrow.

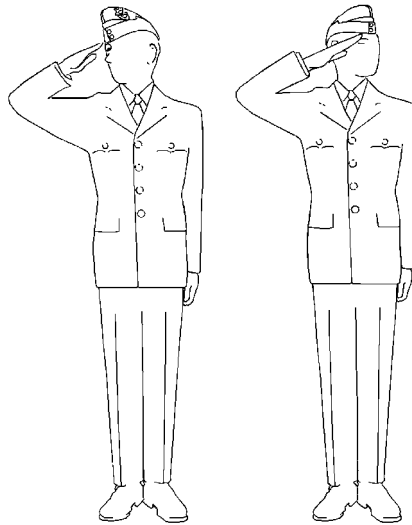

A-PD-201-000/PT-000, The Canadian Forces Manual of Drill and Ceremonial, 2001

Figure 8-2-2 Saluting to the Right and Left

PRACTICE THE SQUAD ON THE FIRST MOVEMENT

Practice the squad on the first movement collectively, individually and collectively.



Constant checking and correcting of all faults is essential. Faults shall be corrected immediately after they occur.

DEMONSTRATE AND EXPLAIN THE SECOND PART OF THE MOVEMENT

On the command SQUAD – TWO, the hand is brought sharply to the position of attention, and simultaneously the head and eyes are turned smartly to the front.

PRACTICE THE SQUAD ON THE SECOND MOVEMENT

Practice the squad on the second movement collectively, individually and collectively.

GIVE TWO COMPLETE AND FINAL DEMONSTRATIONS

On the command TO THE RIGHT (LEFT) – SALUTE, the two movements are combined. The standard pause shall be observed between movements.

The instructor(s) shall provide a full demonstration and allow time for practice.

END OF LESSON CONFIRMATION

The confirmation for this lesson should consist of the cadets, as a squad, practicing saluting at the halt without arms to the front, right and left, and should emphasize movements that cadets showed difficulty with during the class.

Practice the complete movement with the:

- **instructor** calling the time;

- **squad** calling the time; and
- squad **judging** the time.

CONCLUSION

HOMEWORK/READING/PRACTICE

Drill movements are skills that must be practiced individually, in order to make the cadet more proficient as a member of a unit. Cadets are encouraged to practice the movements, as opportunities are made available. Ongoing feedback will be provided, and should be heeded during any drill practice.

METHOD OF EVALUATION

In accordance with A-PD-201-000/PT-000, *The Canadian Forces Manual of Drill and Ceremonial*, the cadet shall participate in an Annual Ceremonial Review (ACR) parade. This movement will be used in preparation for, and execution of, the ACR parade.

CLOSING STATEMENT

The hallmarks of cadet drill are efficiency, precision, and dignity. These qualities are developed through self-discipline and practice. They lead to unit pride and cohesion. Good drill, that is well rehearsed, closely supervised and precise, is an exercise in obedience and alertness. It sets the standard for the execution of any duty, both for the individual and the unit, and builds a sense of confidence between commander and subordinate that is essential to high morale. The personal qualities developed on the parade ground must be maintained in all aspects of life.

INSTRUCTOR NOTES/REMARKS

N/A.

REFERENCES

A0-002 A-PD-201-000/PT-000, DHH 3-2. (2001). *The Canadian Forces Manual of Drill and Ceremonial*. Ottawa, ON: The Department of National Defence.



COMMON TRAINING INSTRUCTIONAL GUIDE



SECTION 3

EO M108.03 – EXECUTE TURNS AT THE HALT

Total Time:

30 min

INTRODUCTION

PRE-LESSON INSTRUCTIONS

A complete list of resources needed for the instruction of this EO is located at Chapter 2 of the QSP. Specific uses for said stores are identified throughout the Instructional Guide, within the teaching point for which they are required.

Prior to instructing this lesson the instructor shall:

- review the lesson content, and become familiar with the material; and
- select the most effective squad formation for the lesson being taught. A squad may be in a single rank, hollow square or semi-circle for elementary drill instruction. (Note: All cadets **must** be able to fully observe all demonstrations and explanations.)

PRE-LESSON ASSIGNMENT

N/A.

APPROACH

This lesson will be presented using the demonstration and performance method. The demonstration and performance method was chosen to allow cadets to participate in supervised exploration of practical instructional material. This method provides the instructor the opportunity to introduce the subject matter, demonstrate and explain procedures, and supervise the cadets while they imitate the skill. This method appeals to all learning styles.



The instructor shall develop and use a vocabulary of short, concise words to impress on the squad that the movements must be performed smartly. For example, the words “crack”, “drive”, “seize” and “grasp” suggest the degree of smartness required. Profanity or personal sarcasm shall never be used.

REVIEW

The pertinent review for this lesson will include:

- EO M108.02 (Section 2).
- The instructor will have the squad execute a salute at the halt without arms and shall continue to review until the squad can perform the movements without hesitation and with ease.

OBJECTIVES

By the end of this lesson the cadet shall be expected to execute turns at the halt.

IMPORTANCE

As members of the Canadian Cadet Movement (CCM) cadets will be required to perform drill movements at a competent level, developing sharpness, esprit de corps, physical coordination, and alertness. These movements will be executed with ease and without hesitation. Ensuring that the cadets efficiently move together as one will promote discipline, alertness, precision, pride, steadiness, and cohesion. This develops the basis of teamwork that the CCM depends on.

Teaching Point 1

Execute Right Turn

Time: 6 min

Method: Demonstration and Performance

DEMONSTRATE THE COMPLETE MOVEMENT WITH TIMING

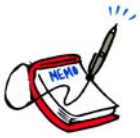

Instructors are reminded that they are to present the example with regards to drill, from the moment they step onto the parade square. Proper drill movements, combined with a professional demeanour, are of paramount importance, and must be exemplified throughout the period of instruction.

The instructor shall provide a complete demonstration of the drill movement, with timing. A practiced assistant instructor may carry out this demonstration.

The demonstration shall be provided from various vantage points, as required.

Turns and inclines are made to change direction: right or left turns change direction by 90°, about turns by 180°, and right and left inclines (not instructed in this lesson) by 45°.

DEMONSTRATE FIRST PART OF MOVEMENT (FIRST NUMBER)



For ease of instruction, drill commands have been broken down into individual movements, or numbers. The instructor(s) shall demonstrate and explain each number.

The cadet shall execute a right turn, by:

On the command RIGHT TURN BY NUMBERS, SQUAD – ONE, turning 90° to the right by pivoting on the right heel and left toe and raising the left heel and right toe simultaneously. Both knees will be kept braced during the turn, arms at the sides and body erect. On the completion of the movement, the weight of the body is placed on the right foot and the left leg is braced with the heel off the ground.

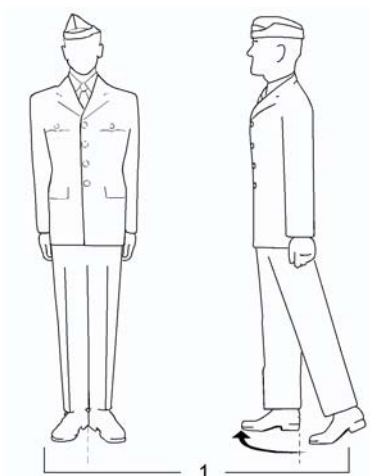

A-PD-201-000/PT-000, The Canadian Forces Manual of Drill and Ceremonial, 2001

Figure 8-3-1 Squad One – Right Turn at the Halt

PRACTICE THE SQUAD ON THE FIRST MOVEMENT

Practice the squad on the first movement collectively, individually and collectively.



Constant checking and correcting of all faults is essential. Faults shall be corrected immediately after they occur.

DEMONSTRATE AND EXPLAIN THE SECOND PART OF THE MOVEMENT

On the command SQUAD – TWO, the cadets shall bend the left knee, straightening it in double time and smartly placing the left foot beside the right to assume the position of attention.

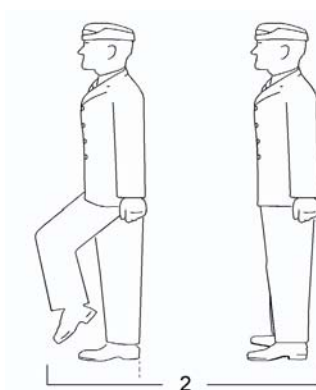

A-PD-201-000/PT-000, The Canadian Forces Manual of Drill and Ceremonial, 2001

Figure 8-3-2 Squad Two – Right Turn at the Halt

PRACTICE THE SQUAD ON THE SECOND MOVEMENT

Practice the squad on the second movement collectively, individually and collectively.

GIVE TWO COMPLETE AND FINAL DEMONSTRATIONS

On the command RIGHT – TURN, combine the two movements. The standard pause shall be observed between the movements.

The instructor(s) shall provide a full demonstration and allow time for practice.



Standard Pause: The standard pause between each movement is two beats in quick time. For example, on the command MOVE TO THE RIGHT IN FILE, RIGHT – TURN, the squad:

1. executes the first movement of the turn on the executive order and simultaneously calls out “ONE”;
2. after completing the first movement, calls “TWO”, “THREE” while observing the standard pause; and
3. when executing the final movement, calls out “ONE”.

Teaching Point 2

Execute Left Turn

Time: 6 min

Method: Demonstration and Performance

DEMONSTRATE THE COMPLETE MOVEMENT WITH TIMING

The instructor shall provide a complete demonstration of the drill movement, with timing. A practiced assistant instructor may carry out this demonstration.

The demonstration shall be provided from various vantage points, as required.

Turns and inclines are made to change direction: right or left turns change direction by 90°, about turns by 180°, and right and left inclines by 45°.

DEMONSTRATE FIRST PART OF MOVEMENT (FIRST NUMBER)

The cadet shall execute a left turn, by:

On the command LEFT TURN BY NUMBERS, SQUAD – ONE, turning 90° to the left by pivoting on the left heel and right toe and raising the right heel and left toe simultaneously. Both knees will be kept braced during the turn, arms at the sides and body erect. On the completion of the movement, the weight of the body is placed on the left foot and the right leg is braced with the heel off the ground.

PRACTICE THE SQUAD ON THE FIRST MOVEMENT

Practice the squad on the first movement collectively, individually and collectively.



Constant checking and correcting of all faults is essential. Faults shall be corrected immediately after they occur.

DEMONSTRATE AND EXPLAIN THE SECOND PART OF THE MOVEMENT (SECOND NUMBER)

On the command SQUAD – TWO, bend the right knee, straightening it in double time and smartly placing the right foot beside the left to assume the position of attention.

PRACTICE THE SQUAD ON THE SECOND MOVEMENT

Practice the squad on the second movement collectively, individually and collectively.



Constant checking and correcting of all faults is essential. Faults shall be corrected immediately after they occur.

GIVE TWO COMPLETE AND FINAL DEMONSTRATIONS

On the command LEFT – TURN, combine the two movements. The standard pause shall be observed between the movements.

The instructor(s) shall provide a full demonstration and allow time for practice.

Teaching Point 3

Execute About Turn

Time: 6 min

Method: Demonstration and Performance

DEMONSTRATE THE COMPLETE MOVEMENT WITH TIMING

The instructor shall provide a complete demonstration of the drill movement, with timing. A practiced assistant instructor may carry out this demonstration.

The demonstration shall be provided from various vantage points, as required.

DEMONSTRATE FIRST PART OF MOVEMENT (FIRST NUMBER)

On the command ABOUT TURN BY NUMBERS, SQUAD – ONE, turning 180° to the right by pivoting on the right heel and left toe and raising the left heel and right toe simultaneously. Both knees will be kept braced during the turn, arms at the sides and body erect. On the completion of the movement, the weight of the body is placed on the right foot and the left leg is braced with the heel off the ground.

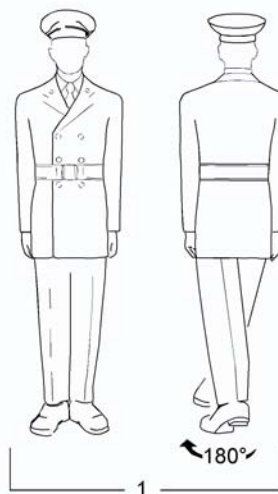

A-PD-201-000/PT-000, *The Canadian Forces Manual of Drill and Ceremonial*, 2001

Figure 8-3-3 Squad One – About Turn at the Halt

PRACTICE THE SQUAD ON THE FIRST MOVEMENT

Practice the squad on the first movement collectively, individually and collectively.



Constant checking and correcting of all faults is essential. Faults shall be corrected immediately after they occur.

DEMONSTRATE AND EXPLAIN THE SECOND PART OF THE MOVEMENT

On the command SQUAD – TWO, bending the left knee, straightening it in double time and smartly placing the left foot beside the right to assume the position of attention.

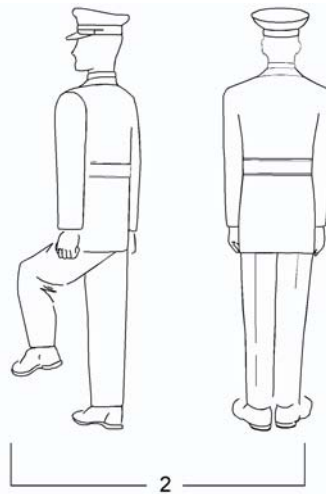

A-PD-201-000/PT-000, The Canadian Forces Manual of Drill and Ceremonial, 2001

Figure 8-3-4 Squad Two – About Turn at the Halt

GIVE TWO COMPLETE AND FINAL DEMONSTRATIONS

On the command ABOUT – TURN, combine the two movements. The standard pause shall be observed between the movements.

The instructor(s) shall provide a full demonstration and allow time for practice.



On the command ABOUT – TURN, combine the two movements. The standard pause shall be observed between the movements.

END OF LESSON CONFIRMATION

The confirmation for this lesson should consist of the cadets, as a squad, practicing executing left and right turns, and about turns and should emphasize movements that cadets showed difficulty with during the class.

Practice the complete movement with the:

- **instructor** calling the time;

- **squad** calling the time; and
- squad **judging** the time.

CONCLUSION

HOMEWORK/READING/PRACTICE

Drill movements are skills that must be practiced individually, in order to make the cadet more proficient as a member of a unit. Cadets are encouraged to practice the movements, as opportunities are made available. Ongoing feedback will be provided, and should be heeded during any drill practice.

METHOD OF EVALUATION

In accordance with A-PD-201-000/PT-000, *The Canadian Forces Manual of Drill and Ceremonial*, the cadet shall participate in an Annual Ceremonial Review (ACR) parade. This movement will be used in preparation for, and in the execution of, the ACR parade.

CLOSING STATEMENT

The hallmarks of cadet drill are efficiency, precision, and dignity. These qualities are developed through self-discipline and practice. They lead to unit pride and cohesion. Good drill that is well rehearsed, closely supervised and precise, is an exercise in obedience and alertness. It sets the standard for the execution of any duty, both for the individual and the unit, and builds a sense of confidence between commander and subordinate that is essential to high morale. The personal qualities developed on the parade ground must be maintained in all aspects of life.

INSTRUCTOR NOTES/REMARKS

N/A.

REFERENCES

A0-002 A-PD-201-000/PT-000, DHH 3-2. (2001). *The Canadian Forces Manual of Drill and Ceremonial*. Ottawa, ON: The Department of National Defence.

THIS PAGE INTENTIONALLY LEFT BLANK



COMMON TRAINING INSTRUCTIONAL GUIDE



SECTION 4

EO M108.04 – CLOSE TO THE RIGHT AND LEFT

Total Time:

30 min

INTRODUCTION

PRE-LESSON INSTRUCTIONS

A complete list of resources needed for the instruction of this EO is located at Chapter 2 of the QSP. Specific uses for said stores are identified throughout the Instructional Guide, within the teaching point for which they are required.

Prior to instructing this lesson the instructor shall:

- review the lesson content, and become familiar with the material; and
- select the most effective squad formation for the lesson being taught. A squad may be in a single rank, hollow square or semi-circle for elementary drill instruction. (Note: All cadets **must** be able to fully observe all demonstrations and explanations.)

PRE-LESSON ASSIGNMENT

N/A.

APPROACH

This lesson will be presented using the demonstration and performance method. The demonstration and performance method was chosen to allow cadets to participate in supervised exploration of practical instructional material. This method provides the instructor the opportunity to introduce the subject matter, demonstrate and explain procedures, and supervise the cadets while they imitate the skill. This method appeals to all learning styles.



The instructor shall develop and use a vocabulary of short, concise words to impress on the squad that the movements must be performed smartly. For example, the words “crack”, “drive”, “seize” and “grasp” suggest the degree of smartness required. Profanity or personal sarcasm shall never be used.

REVIEW

N/A.

OBJECTIVES

By the end of this lesson the cadet shall be expected to close to the right and left.

IMPORTANCE

As members of the Canadian Cadet Movement (CCM) cadets will be required to perform drill movements at a competent level, developing sharpness, esprit de corps, physical coordination, and alertness. These movements will be executed with ease and without hesitation. Ensuring that the cadets efficiently move together as one will promote discipline, alertness, precision, pride, steadiness, and cohesion. This develops the basis of teamwork that the CCM depends on.

Teaching Point 1**Closing to the Right**

Time: 13 min

Method: Demonstration and Performance

DEMONSTRATE THE COMPLETE MOVEMENT WITH TIMING

Instructors are reminded that they are to present the example with regards to drill, from the moment they step onto the parade square. Proper drill movements, combined with a professional demeanour, are of paramount importance, and must be exemplified throughout the period of instruction.

The instructor shall provide a complete demonstration of the drill movement, with timing. A practiced assistant instructor may carry out this demonstration.

The demonstration shall be provided from various vantage points, as required.

Closing to the right is executed in order to adjust position right. Close march paces to the right shall not be ordered when the distance required to move exceeds eight paces. When the distance is greater, the squad shall be turned and marched the required distance.

DEMONSTRATE FIRST PART OF MOVEMENT (FIRST NUMBER)

For ease of instruction, drill commands have been broken down into individual movements, or numbers. The instructor(s) shall demonstrate and explain each number.

On the command ONE PACE RIGHT CLOSE MARCH BY NUMBERS, SQUAD – ONE, the cadet shall complete the first number of close march paces to the right by:

1. bending the right knee, carry the foot to the right and place it smartly on the ground with the inside of the heels one side pace 25 cm apart;
2. balancing the weight of the body evenly on both feet; and
3. keeping the arms still at the sides.

PRACTICE THE SQUAD ON THE FIRST MOVEMENT

Practice the squad on the first movement collectively, individually and collectively.

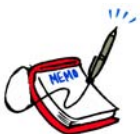

Constant checking and correcting of all faults is essential. Faults shall be corrected immediately after they occur.

DEMONSTRATE AND EXPLAIN THE SECOND PART OF THE MOVEMENT (SECOND NUMBER)

On the command SQUAD – TWO, the cadet shall execute the second number of the movement by:

1. shifting the weight of the body to the right foot; and
2. bending the left knee and placing the left foot smartly by the right to assume the position of attention.

PRACTICE THE SQUAD ON THE SECOND MOVEMENT

Practice the squad on the second movement collectively, individually and collectively.

GIVE TWO COMPLETE AND FINAL DEMONSTRATIONS

On the command ONE PACE RIGHT CLOSE – MARCH, combine the two movements, observing the following timing:

1. for one pace, “one-one”;
2. for two paces, “one-one, pause, one-two”;
3. for three paces, “one-one, pause, one-two, pause, one-three”, etc.

The instructor(s) shall provide a full demonstration and allow time for practice.



Standard Pause: The standard pause between each movement is two beats in quick time. For example, on the command MOVE TO THE RIGHT IN FILE, RIGHT – TURN, the squad:

1. executes the first movement of the turn on the executive order and simultaneously calls out “ONE”;
2. after completing the first movement, calls “TWO”, “THREE” while observing the standard pause; and
3. when executing the final movement, calls out “ONE”.

Teaching Point 2**Closing to the Left**

Time: 12 min

Method: Demonstration and Performance

DEMONSTRATE THE COMPLETE MOVEMENT WITH TIMING

The instructor shall provide a complete demonstration of the drill movement, with timing. A practiced assistant instructor may carry out this demonstration.

The demonstration shall be provided from various vantage points, as required.

Closing to the left is executed in order to adjust position left. Close march paces to the left shall not be ordered when the distance required to move exceeds eight paces. When the distance is greater, the squad shall be turned and marched the required distance.

DEMONSTRATE FIRST PART OF MOVEMENT (FIRST NUMBER)

For ease of instruction, drill commands have been broken down into individual movements, or numbers. The instructor(s) shall demonstrate and explain each number.

On the command ONE PACE LEFT CLOSE MARCH BY NUMBERS, SQUAD – ONE, the cadet shall complete the first number of the movement by:

1. bending the left knee, carry the foot to the left and place it smartly on the ground with the inside of the heels one side pace 25 cm apart;
2. balancing the weight of the body evenly on both feet; and
3. keeping the arms still at the sides.

PRACTICE THE SQUAD ON THE FIRST MOVEMENT

Practice the squad on the first movement collectively, individually and collectively.



Constant checking and correcting of all faults is essential. Faults shall be corrected immediately after they occur.

DEMONSTRATE AND EXPLAIN THE SECOND PART OF THE MOVEMENT (SECOND NUMBER)

On the command SQUAD – TWO, the cadet shall complete the second number of the movement by:

1. shifting the weight of the body to the left foot; and
2. bending the right knee and placing the right foot smartly by the left to assume the position of attention.

PRACTICE THE SQUAD ON THE SECOND MOVEMENT

Practice the squad on the second movement collectively, individually and collectively.

GIVE TWO COMPLETE AND FINAL DEMONSTRATIONS

On the command ONE PACE LEFT CLOSE – MARCH, combine the two movements, observing the following timing:

1. for one pace, “one-one”;
2. for two paces, “one-one, pause, one-two”; and
3. for three paces, “one-one, pause, one-two, pause, one-three”, etc.

END OF LESSON CONFIRMATION

The confirmation for this lesson should consist of the cadets, as a squad, practicing closing to the right and left, and should emphasize movements that cadets showed difficulty with during the class.

Practice the complete movement with the:

- **instructor** calling the time;
- **squad** calling the time; and
- **squad judging** the time.

CONCLUSION

HOMEWORK/READING/PRACTICE

Drill movements are skills that must be practiced individually, in order to make the cadet more proficient as a member of a unit. Cadets are encouraged to practice the movements, as opportunities are made available. Ongoing feedback will be provided, and should be heeded during any drill practice.

METHOD OF EVALUATION

In accordance with A-PD-201-000/PT-000, *The Canadian Forces Manual of Drill and Ceremonial*, the cadet shall participate in an Annual Ceremonial Review (ACR) parade. This movement will be used in preparation for, and in the execution of, the ACR parade.

CLOSING STATEMENT

The hallmarks of cadet drill are efficiency, precision, and dignity. These qualities are developed through self-discipline and practice. They lead to unit pride and cohesion. Good drill that is well rehearsed, closely supervised and precise, is an exercise in obedience and alertness. It sets the standard for the execution of any duty, both for the individual and the unit, and builds a sense of confidence between commander and subordinate that is essential to high morale. The personal qualities developed on the parade ground must be maintained in all aspects of life.

INSTRUCTOR NOTES/REMARKS

N/A.

REFERENCES

A0-002 A-PD-201-000/PT-000, DHH 3-2. (2001). *The Canadian Forces Manual of Drill and Ceremonial*. Ottawa, ON: The Department of National Defence.

THIS PAGE INTENTIONALLY LEFT BLANK



COMMON TRAINING INSTRUCTIONAL GUIDE



SECTION 5

EO M108.05 – EXECUTE PACES FORWARD AND TO THE REAR

Total Time:

30 min

INTRODUCTION

PRE-LESSON INSTRUCTIONS

A complete list of resources needed for the instruction of this EO is located at Chapter 2 of the QSP. Specific uses for said stores are identified throughout the Instructional Guide, within the teaching point for which they are required.

Prior to instructing this lesson the instructor shall:

- review the lesson content, and become familiar with the material; and
- select the most effective squad formation for the lesson being taught. A squad may be in a single rank, hollow square or semi-circle for elementary drill instruction. (Note: All cadets **must** be able to fully observe all demonstrations and explanations.)

PRE-LESSON ASSIGNMENT

N/A.

APPROACH

This lesson will be presented using the demonstration and performance method. The demonstration and performance method was chosen to allow cadets to participate in supervised exploration of practical instructional material. This method provides the instructor the opportunity to introduce the subject matter, demonstrate and explain procedures, and supervise the cadets while they imitate the skill. This method appeals to all learning styles.



The instructor shall develop and use a vocabulary of short, concise words to impress on the squad that the movements must be performed smartly. For example, the words “crack”, “drive”, “seize” and “grasp” suggest the degree of smartness required. Profanity or personal sarcasm shall never be used.

REVIEW

The pertinent review for this lesson will include:

- EO M108.04 (Section 4).
- The instructor will have the squad execute close to the right and the left. The instructor will continue to review until the squad can perform the movement without hesitation and with ease.

OBJECTIVES

By the end of this lesson the cadet shall be expected to execute paces forward and to the rear.

IMPORTANCE

As members of the Canadian Cadet Movement (CCM) cadets will be required to perform drill movements at a competent level, developing sharpness, esprit de corps, physical coordination, and alertness. These movements will be executed with ease and without hesitation. Ensuring that the cadets efficiently move together as one will promote discipline, alertness, precision, pride, steadiness, and cohesion. This develops the basis of teamwork that the CCM depends on.

Teaching Point 1

Execute Paces Forward

Time: 10 min

Method: Demonstration and Performance

DEMONSTRATE THE COMPLETE MOVEMENT WITH TIMING

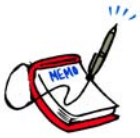

Instructors are reminded that they are to present the example with regards to drill, from the moment they step onto the parade square. Proper drill movements, combined with a professional demeanour, are of paramount importance, and must be exemplified throughout the period of instruction.

The instructor shall provide a complete demonstration of the drill movement, with timing. A practiced assistant instructor may carry out this demonstration.

The demonstration shall be provided from various vantage points, as required.

Paces forward are executed in order to adjust position forward. A cadet shall not be moved forward, more than three paces, by this method. When the distance is greater the cadet will be marched the required distance.

DEMONSTRATE FIRST PART OF MOVEMENT (FIRST NUMBER)



For ease of instruction, drill commands have been broken down into individual movements, or numbers. The instructor(s) shall demonstrate and explain each number.

On the command ONE PACE FORWARD MARCH BY NUMBERS, SQUAD – ONE, the cadet shall complete the first number of the movement by:

1. shooting the left foot forward one half pace, forcing the weight forward on the left foot, with the right heel raised; and
2. keeping the arms still at the sides.

PRACTICE THE SQUAD ON THE FIRST MOVEMENT

Practice the squad on the first movement collectively, individually and collectively.



Constant checking and correcting of all faults is essential. Faults shall be corrected immediately after they occur.

DEMONSTRATE AND EXPLAIN THE SECOND PART OF THE MOVEMENT

On the command SQUAD – TWO, the cadet shall complete the second part of the movement by:

1. bending the right knee, straightening it in double time, placing the right foot smartly on the ground beside the left; and
2. assuming the position of attention.

PRACTICE THE SQUAD ON THE SECOND MOVEMENT

Practice the squad on the second movement collectively, individually and collectively.

GIVE TWO COMPLETE AND FINAL DEMONSTRATIONS

Combine the preceding movements with timing. The instructor(s) shall provide a full demonstration and allow time for practice.

On the command ONE PACE FORWARD – MARCH, combine the movements, observing the following timing:

1. for one pace, “one-two”;
2. for two paces, “one, one-two”; and
3. for three paces, “one, one, one-two”.



When taking paces forward and to the rear:

1. the cadence shall be in quick time;
2. the length of each step shall be one half pace (35 cm); and
3. the arms shall be kept still at the sides.

Teaching Point 2

Execute Paces to the Rear

Time: 10 min

Method: Demonstration and Performance

DEMONSTRATE THE COMPLETE MOVEMENT WITH TIMING

The instructor shall provide a complete demonstration of the drill movement, with timing. A practiced assistant instructor may carry out this demonstration.

The demonstration shall be provided from various vantage points, as required.

Paces to the rear are executed in order to adjust position back. A cadet shall not be moved back more than three paces by this method. When the distance is greater the cadet will be marched the required distance.

DEMONSTRATE FIRST PART OF MOVEMENT (FIRST NUMBER)

On the command ONE PACE STEP BACK MARCH BY NUMBERS, SQUAD – ONE, the cadet shall execute the first number of the movement by:

1. shooting the left foot to the rear one half pace with the weight forward on the right foot and the left heel raised; and
2. keeping the arms still at the sides.

PRACTICE THE SQUAD ON THE FIRST MOVEMENT

Practice the squad on the first movement collectively, individually and collectively.



Constant checking and correcting of all faults is essential. Faults shall be corrected immediately after they occur.

DEMONSTRATE AND EXPLAIN THE SECOND PART OF THE MOVEMENT

On the command SQUAD – TWO, the cadet shall execute the second number of the movement by:

1. bending the right knee, straightening it in double time, place the right foot smartly on the ground beside the left; and
2. assuming the position of attention.

PRACTICE THE SQUAD ON THE SECOND MOVEMENT

Practice the squad on the second movement collectively, individually and collectively.



Constant checking and correcting of all faults is essential. Faults shall be corrected immediately after they occur.

GIVE TWO COMPLETE AND FINAL DEMONSTRATIONS

Combine the preceding movements with timing. The instructor(s) shall provide a full demonstration and allow time for practice.

On the command ONE PACE(S) STEP BACK – MARCH, combine the movements, observing the following timing:

1. for one pace, “one-two”;
2. for two paces, “one, one-two”; and
3. for three paces, “one, one, one-two”.

END OF LESSON CONFIRMATION

The confirmation for this lesson should consist of the cadets, as a squad, practicing both paces forward and to the rear, and should emphasise movements that cadets showed difficulty with during the class.

Practice the complete movement with the:

- **instructor** calling the time;
- **squad** calling the time; and
- squad **judging** the time.

CONCLUSION

HOMEWORK/READING/PRACTICE

Drill movements are skills that must be practiced individually, in order to make the cadet more proficient as a member of a unit. Cadets are encouraged to practice the movements, as opportunities are made available. Ongoing feedback will be provided, and should be heeded during any drill practice.

METHOD OF EVALUATION

In accordance with A-PD-201-000/PT-000, *The Canadian Forces Manual of Drill and Ceremonial*, the cadet shall participate in an Annual Ceremonial Review (ACR) parade. This movement will be used in preparation for, and execution of, the ACR parade.

CLOSING STATEMENT

The hallmarks of cadet drill are efficiency, precision, and dignity. These qualities are developed through self-discipline and practice. They lead to unit pride and cohesion. Good drill, well rehearsed, closely supervised and precise, is an exercise in obedience and alertness. It sets the standard for the execution of any duty, both for the individual and the unit, and builds a sense of confidence between commander and subordinate that is essential to high morale. The personal qualities developed on the parade ground must be maintained in all aspects of military life.

INSTRUCTOR NOTES/REMARKS

N/A.

REFERENCES

- A0-002 A-PD-201-000/PT-000, DHH 3-2. (2001). *The Canadian Forces Manual of Drill and Ceremonial*. Ottawa, ON: The Department of National Defence.

THIS PAGE INTENTIONALLY LEFT BLANK



COMMON TRAINING INSTRUCTIONAL GUIDE



SECTION 6

EO M108.06 – EXECUTE THE MOVEMENTS REQUIRED FOR A RIGHT DRESS

Total Time:

30 min

INTRODUCTION

PRE-LESSON INSTRUCTIONS

A complete list of resources needed for the instruction of this EO is located at Chapter 2 of the QSP. Specific uses for said stores are identified throughout the Instructional Guide, within the teaching point for which they are required.

Prior to instructing this lesson the instructor shall:

- review the lesson content, and become familiar with the material; and
- select the most effective squad formation for the lesson being taught. A squad may be in a single rank, hollow square or semi-circle for elementary drill instruction. (Note: All cadets **must** be able to fully observe all demonstrations and explanations).

PRE-LESSON ASSIGNMENT

N/A.

APPROACH

This lesson will be presented using the demonstration and performance method. The demonstration and performance method was chosen to allow cadets to participate in supervised exploration of practical instructional material. This method provides the instructor the opportunity to introduce the subject matter, demonstrate and explain procedures, and supervise the cadets while they imitate the skill. This method appeals to all learning styles.



The instructor shall develop and use a vocabulary of short, concise words to impress on the squad that the movements must be performed smartly. For example, the words “crack”, “drive”, “seize” and “grasp” suggest the degree of smartness required. Profanity or personal sarcasm shall never be used.

REVIEW

The pertinent review for this lesson will include:

- EO M108.05 (Section 5).
- The instructor will have the squad execute paces forward and to the rear will continue to review until the squad can perform the movements without hesitation and with ease.

OBJECTIVES

By the end of this lesson the cadet shall be expected to execute the movements required for a right dress.

IMPORTANCE

As members of the Canadian Cadet Movement (CCM) cadets will be required to perform drill movements at a competent level, developing sharpness, esprit de corps, physical coordination, and alertness. These movements will be executed with ease and without hesitation. Ensuring that the cadets efficiently move together as one will promote discipline, alertness, precision, pride, steadiness, and cohesion. This develops the basis of teamwork that the CCM depends on.

Teaching Point 1

Execute Right Dress

Time: 10 min

Method: Demonstration and Performance

DEMONSTRATE THE COMPLETE MOVEMENT WITH TIMING



Instructors are reminded that they are to present the example with regards to drill, from the moment they step onto the parade square. Proper drill movements, combined with a professional demeanour, are of paramount importance, and must be exemplified throughout the period of instruction.

The instructor shall provide a complete demonstration of the drill movement, with timing. A practiced assistant instructor may carry out this demonstration.

The demonstration shall be provided from various vantage points, as required.

Dressing of a squad is required to ensure a uniform, organized appearance when in a formed body. The most common movement used to dress a squad is the right dress.

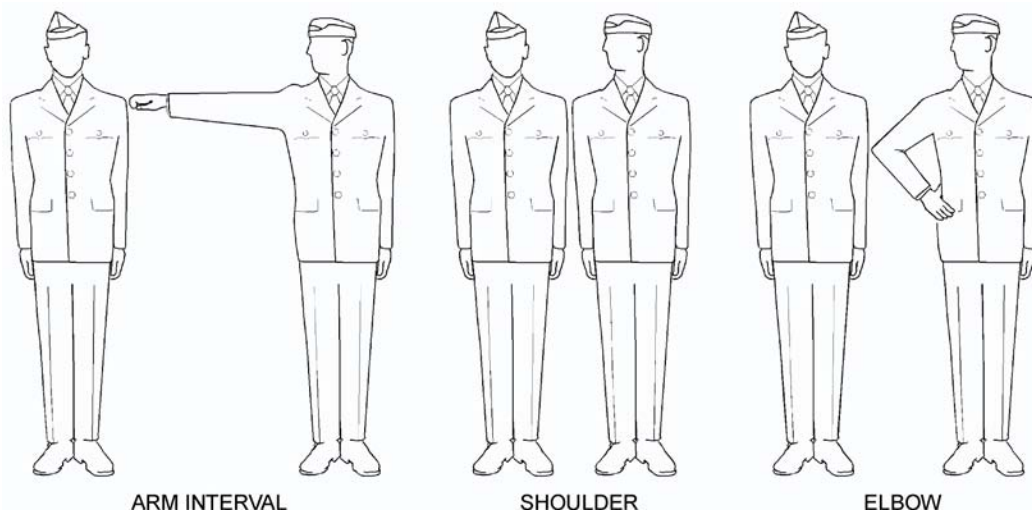

A-PD-201-000/PT-000, The Canadian Forces Manual of Drill and Ceremonial, 2001

Figure 8-6-1 Dressing a Squad

DEMONSTRATE FIRST PART OF MOVEMENT (FIRST NUMBER)

For ease of instruction, drill commands have been broken down into individual movements, or numbers. The instructor(s) shall demonstrate and explain each number.

On the command RIGHT DRESS BY NUMBERS, SQUAD – ONE, the cadet shall complete the first number of the movement by:

1. the right-hand individual of the front rank standing fast; and
2. the remainder shooting the left foot forward, bending the right knee and adopting the position of attention.

PRACTICE THE SQUAD ON THE FIRST MOVEMENT

Practice the squad on the first movement collectively, individually and collectively.



Constant checking and correcting of all faults is essential. Faults shall be corrected immediately after they occur.

DEMONSTRATE AND EXPLAIN THE SECOND PART OF THE MOVEMENT (SECOND NUMBER)

On the command SQUAD – TWO, the cadet shall execute the second number of the movement by:

1. the right file standing fast;
2. the remainder turning head and eyes to the right as far as possible without straining; and
3. simultaneously, the front rank, except the right-hand individual, shooting the right arm its full extent behind the shoulder of the one on the right. The hand is closed as in the position of attention, back of the hand uppermost and arm parallel to the ground.

PRACTICE THE SQUAD ON THE SECOND MOVEMENT

Practice the squad on the second movement collectively, individually and collectively.

DEMONSTRATE AND EXPLAIN THE THIRD PART OF THE MOVEMENT (THIRD NUMBER)

On the command SQUAD – THREE, the cadet shall execute the third number of the movement by:

1. the right-hand individual of the front rank standing fast; and
2. the remainder taking up correct alignment, distance and covering by taking short, quick paces until they are in the correct position beginning with the left foot.

PRACTICE THE SQUAD ON THE THIRD MOVEMENT

Practice the squad on the third movement collectively, individually and collectively.

GIVE TWO COMPLETE AND FINAL DEMONSTRATIONS

Combine the preceding movements with timing. The instructor(s) shall provide a full demonstration and allow time for practice.

On the command RIGHT – DRESS, combine the movements, and observe the standard pause between the movements. The timing shall be called “one-two, pause, arms, pause, move.”



Standard Pause: The standard pause between each movement is two beats in quick time. For example, on the command MOVE TO THE RIGHT IN FILE, RIGHT – TURN, the squad:

1. executes the first movement of the turn on the executive order and simultaneously calls out “ONE”;
2. after completing the first movement, calls “TWO”, “THREE” while observing the standard pause; and
3. when executing the final movement, calls out “ONE”.



When dressing by the left, the same drill is followed except the head and eyes are turned left and the left arm is raised. The left-hand individual stands fast, looks to the front, and those in the file behind adopt the appropriate distance between ranks.



Dressing may be ordered by the centre when required if more than one squad is on parade in line or mass. The command is INWARD – DRESS, and flanking squads shall dress by their left or right as appropriate.



When a squad is formed with only one person in the blank file, that individual shall dress with the front rank when the squad is advancing and with the rear rank when the squad is retiring. When the squad is moving to a flank, the individual shall dress with the directing flank.

Teaching Point 2

Execute Eyes Front

Time: 5 min

Method: Demonstration and Performance

DEMONSTRATE AND EXPLAIN THE MOVEMENT

The cadet shall complete the eyes-front, by:

On the command EYES – FRONT, snapping the head and eyes to the front and cutting the right arm smartly to the rear of the individual on the right and to the position of attention without slapping the thigh.

PRACTICE THE COMPLETE MOVEMENT

Practice the movement collectively, individually and collectively.



Constant checking and correcting of all faults is essential. Faults shall be corrected immediately after they occur.

Teaching Point 3**Execute Elbow Dress**

Time: 5 min

Method: Demonstration and Performance

DEMONSTRATE AND EXPLAIN THE MOVEMENT

On the command ELBOW DRESSING, RIGHT – DRESS, dressing is carried out as for the right dress except, during the second part of the movement:

1. the right hand is placed on the hip or belt as applicable;
2. fingers are closed, pointed down and extended forward;
3. thumbs are to the rear; and
4. the point of the elbow is forced forward and touching the individual's arm on the right.

PRACTICE THE SQUAD ON THE FIRST MOVEMENT

Practice the squad on the first movement collectively, individually and collectively.



Constant checking and correcting of all faults is essential. Faults shall be corrected immediately after they occur.

Teaching Point 4**Execute Shoulder Dress**

Time: 5 min

Method: Demonstration and Performance

DEMONSTRATE AND EXPLAIN THE MOVEMENT

On the command SHOULDER DRESSING, RIGHT – DRESS, dressing is carried out as for the right dress, except that the arms are not raised and dressing is taken up without arm's length interval. Enough lateral space is left between the shoulders of each person in the rank to complete any movements that may follow the dressing.

PRACTICE THE SQUAD ON THE SECOND MOVEMENT

Practice the squad on the second movement collectively, individually and collectively.



Constant checking and correcting of all faults is essential. Faults shall be corrected immediately after they occur.

END OF LESSON CONFIRMATION

The confirmation for this lesson should consist of the cadets, as a squad, practicing the movements required for a right dress, and should emphasize movements that cadets showed difficulty with during the class.

Practice the complete movement, with the:

- **instructor** calling the time;
- **squad** calling the time; and
- squad **judging** the time.

CONCLUSION

HOMEWORK/READING/PRACTICE

Drill movements are skills that must be practiced individually, in order to make the cadet more proficient as a member of a unit. Cadets are encouraged to practice the movements, as opportunities are made available. Ongoing feedback will be provided, and should be heeded during any drill practice.

METHOD OF EVALUATION

In accordance with A-PD-201-000/PT-000, *The Canadian Forces Manual of Drill and Ceremonial*, the cadet shall participate in an Annual Ceremonial Review (ACR) parade. This movement will be used in preparation for, and in the execution of, the ACR parade.

CLOSING STATEMENT

The hallmarks of cadet drill are efficiency, precision, and dignity. These qualities are developed through self-discipline and practice. They lead to unit pride and cohesion. Good drill that is well rehearsed, closely supervised and precise, is an exercise in obedience and alertness. It sets the standard for the execution of any duty, both for the individual and the unit, and builds a sense of confidence between commander and subordinate that is essential to high morale. The personal qualities developed on the parade ground must be maintained in all aspects of life.

INSTRUCTOR NOTES/REMARKS

N/A.

REFERENCES

A0-002 A-PD-201-000/PT-000 DHH 3-2. (2001). *The Canadian Forces Manual of Drill and Ceremonial*. Ottawa, ON: The Department of National Defence.



COMMON TRAINING INSTRUCTIONAL GUIDE



SECTION 7

EO M108.07 – EXECUTE AN OPEN ORDER AND CLOSE ORDER MARCH

Total Time:

30 min

INTRODUCTION

PRE-LESSON INSTRUCTIONS

A complete list of resources needed for the instruction of this EO is located at Chapter 2 of the QSP. Specific uses for said stores are identified throughout the Instructional Guide, within the teaching point for which they are required.

Prior to instructing this lesson the instructor shall:

- review the lesson content, and become familiar with the material; and
- select the most effective squad formation for the lesson being taught. A squad may be in a single rank, hollow square or semi-circle for elementary drill instruction. (Note: All cadets **must** be able to fully observe all demonstrations and explanations.)

PRE-LESSON ASSIGNMENT

N/A.

APPROACH

This lesson will be presented using the demonstration and performance method. The demonstration and performance method was chosen to allow cadets to participate in supervised exploration of practical instructional material. This method provides the instructor the opportunity to introduce the subject matter, demonstrate and explain procedures, and supervise the cadets while they imitate the skill. This method appeals to all learning styles.



The instructor shall develop and use a vocabulary of short, concise words to impress on the squad that the movements must be performed smartly. For example, the words “crack”, “drive”, “seize” and “grasp” suggest the degree of smartness required. Profanity or personal sarcasm shall never be used.

REVIEW

The pertinent review for this lesson will include:

- EO M108.06 (Section 6).
- The instructor will have the squad execute a right dress, and will continue to review until the squad can perform the movement without hesitation and with ease.

OBJECTIVES

By the end of this lesson the cadet shall be expected to execute an open order and close order march.

IMPORTANCE

As members of the Canadian Cadet Movement (CCM) cadets will be required to perform drill movements at a competent level, developing sharpness, esprit de corps, physical coordination, and alertness. These movements will be executed with ease and without hesitation. Ensuring that the cadets efficiently move together as one will promote discipline, alertness, precision, pride, steadiness, and cohesion. This develops the basis of teamwork that the CCM depends on.

Teaching Point 1

Execute an Open Order March

Time: 15 min

Method: Demonstration and Performance

DEMONSTRATE THE COMPLETE MOVEMENT WITH TIMING



Instructors are reminded that they are to present the example with regards to drill, from the moment they step onto the parade square. Proper drill movements, combined with a professional demeanour, are of paramount importance, and must be exemplified throughout the period of instruction.

The instructor shall provide a complete demonstration of the drill movement, with timing. A practiced assistant instructor may carry out this demonstration.

The demonstration shall be provided from various vantage points, as required.

When in a formed body, cadets are inspected at the open order. In order to adopt this formation, cadets are required to execute the open order march.

The cadet will execute the open order march by the:

- front rank moving forward three half paces;
- rear rank stepping back three half paces; and
- centre rank standing fast.



A-PD-201-000/PT-000, The Canadian Forces Manual of Drill and Ceremonial, 2001

Figure 8-7-1 Open Order March in Three Ranks

When formed in two ranks, the front rank stands fast and the rear rank steps back three half paces.

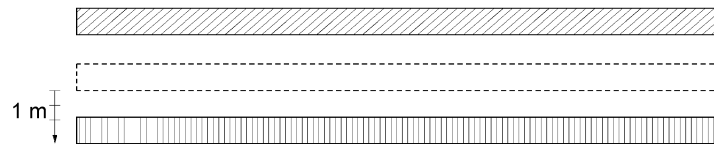

A-PD-201-000/PT-000, The Canadian Forces Manual of Drill and Ceremonial, 2001

Figure 8-7-2 Open Order March in Two Ranks

On the command OPEN ORDER – MARCH, the movements shall be executed as for three check paces forward and to the rear, the final movement being executed by:

1. bending the right knee, straightening it in double time and placing the right foot smartly on the ground by the left; and
2. assuming the position of attention.

PRACTICE THE SQUAD ON THE MOVEMENT

Practice the squad on the movement collectively, individually and collectively.



Constant checking and correcting of all faults is essential. Faults shall be corrected immediately after they occur.

GIVE TWO COMPLETE AND FINAL DEMONSTRATIONS

The cadence shall be in quick time, and the arms shall be kept still at the sides.

The timing for the movements is counted as “one, one, one-two.”

The instructor(s) shall provide a full demonstration and allow time for practice.



The instructor is to allow the cadets an opportunity to practice the open order march as a member of the front, rear and centre ranks. This is best accomplished by having the ranks change places quickly during the practice stage of the teaching point.

Teaching Point 2

Execute Close Order March

Time: 10 min

Method: Demonstration and Performance

DEMONSTRATE THE COMPLETE MOVEMENT WITH THE TIMING

The instructor shall provide a complete demonstration of the drill movement, with timing. A practiced assistant instructor may carry out this demonstration.

The demonstration shall be provided from various vantage points, as required.

The cadet shall execute the close order march by the:

1. front rank stepping back three half paces;
2. front rank moving forward three half paces; and

3. centre rank standing fast.

On the command CLOSE ORDER – MARCH, the movements will be executed as for three check paces forward and to the rear, the final movement being executed by:

1. bending the right knee, straightening it in double time and placing the right foot smartly on the ground by the left; and
2. assuming the position of attention.

PRACTICE THE SQUAD ON THE MOVEMENT

Practice the squad on movement collectively, individually and collectively.

GIVE TWO COMPLETE AND FINAL DEMONSTRATIONS

The cadence shall be in quick time, and the arms shall be kept still at the sides.

The timing for the movements is counted as “one, one, one-two.”

The instructor(s) shall provide a full demonstration and allow time for practice.



When formed in two ranks, the front rank stands fast and the rear rank moves forward three half paces.



The instructor is to allow the cadets an opportunity to practice the close order march as a member of the front, rear and centre ranks. This is best accomplished by having the ranks change places quickly during the practice stage of the teaching point.

END OF LESSON CONFIRMATION

The confirmation for this lesson should consist of the cadets, as a squad, practicing open order and close order march, and should emphasise movements that cadets showed difficulty with during the class.

Practice the complete movement with the:

- **instructor** calling the time;
- **squad** calling the time; and
- squad **judging** the time.

CONCLUSION

HOMEWORK/READING/PRACTICE

Drill movements are skills that must be practiced individually, in order to make the cadet more proficient as a member of a unit. Cadets are encouraged to practice the movements, as opportunities are made available. Ongoing feedback will be provided, and should be heeded during any drill practice.

METHOD OF EVALUATION

In accordance with A-PD-201-000/PT-000, *The Canadian Forces Manual of Drill and Ceremonial*, the cadet shall participate in an Annual Ceremonial Review (ACR) parade. This movement will be used in preparation for, and in the execution of, the ACR parade.

CLOSING STATEMENT

The hallmarks of cadet drill are efficiency, precision, and dignity. These qualities are developed through self-discipline and practice. They lead to unit pride and cohesion. Good drill, well rehearsed, closely supervised and precise, is an exercise in obedience and alertness. It sets the standard for the execution of any duty, both for the individual and the unit, and builds a sense of confidence between commander and subordinate that is essential to high morale. The personal qualities developed on the parade ground must be maintained in all aspects of cadet life.

INSTRUCTOR NOTES/REMARKS

N/A.

REFERENCES

A0-002 A-PD-201-000/PT-000 DHH 3-2. (2001). *The Canadian Forces Manual of Drill and Ceremonial*. Ottawa, ON: The Department of National Defence.

THIS PAGE INTENTIONALLY LEFT BLANK



COMMON TRAINING INSTRUCTIONAL GUIDE



SECTION 8

EO M108.08 – MARCH AND HALT IN QUICK TIME

Total Time:	30 min
-------------	--------

INTRODUCTION

PRE-LESSON INSTRUCTIONS

A complete list of resources needed for the instruction of this EO is located at Chapter 2 of the QSP. Specific uses for said stores are identified throughout the Instructional Guide, within the teaching point for which they are required.

Prior to instructing this lesson the instructor shall:

- review the lesson content, and become familiar with the material; and
- select the most effective squad formation for the lesson being taught. A squad may be in a single rank, hollow square or semi-circle for elementary drill instruction. (Note: All cadets **must** be able to fully observe all demonstrations and explanations.)

PRE-LESSON ASSIGNMENT

N/A.

APPROACH

This lesson will be presented using the demonstration and performance method. The demonstration and performance method was chosen to allow cadets to participate in supervised exploration of practical instructional material. This method provides the instructor the opportunity to introduce the subject matter, demonstrate and explain procedures, and supervise the cadets while they imitate the skill. This method appeals to all learning styles.



The instructor shall develop and use a vocabulary of short, concise words to impress on the squad that the movements must be performed smartly. For example, the words “crack”, “drive”, “seize” and “grasp” suggest the degree of smartness required. Profanity or personal sarcasm shall never be used.

REVIEW

The pertinent review for this lesson will include:

- EO M108.07 (Section 7).
- The instructor will have the cadets execute an open order march and close order march, and shall continue to review until the squad can perform the movements without hesitation and with ease.

OBJECTIVES

By the end of this lesson the cadet shall be expected to march and halt in quick time.

IMPORTANCE

As members of the Canadian Cadet Movement (CCM) cadets will be required to perform drill movements at a competent level, developing sharpness, esprit de corps, physical coordination, and alertness. These movements will be executed with ease and without hesitation. Ensuring that the cadets efficiently move together as one will promote discipline, alertness, precision, pride, steadiness, and cohesion. This develops the basis of teamwork that the CCM depends on.

Teaching Point 1

March in Quick Time

Time: 10 min

Method: Demonstration and Performance

DEMONSTRATE THE COMPLETE MOVEMENT WITH TIMING

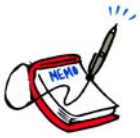

Instructors are reminded that they are to present the example with regards to drill, from the moment they step onto the parade square. Proper drill movements, combined with a professional demeanour, are of paramount importance, and must be exemplified throughout the period of instruction.

The instructor shall provide a complete demonstration of the drill movement, with timing. A practiced assistant instructor may carry out this demonstration.

The demonstration shall be provided from various vantage points, as required.

Cadet units march and manoeuvre on foot in quick, slow, and double time. When marching in quick time, the cadence is set at 120 paces per minute. All cadet units shall practice, and be prepared to march and manoeuvre with other cadet units, at the standard cadence.

The quick march can be maintained for long periods of time and is the standard for routine duty.

The standard length of pace is 75 cm.

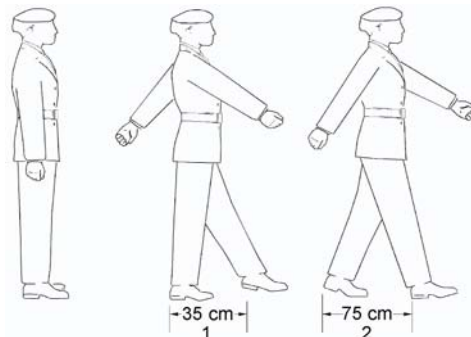

A-PD-201-000/PT-000, The Canadian Forces Manual of Drill and Ceremonial, 2001

Figure 8-8-1 Marching in Quick Time

DEMONSTRATE FIRST PART OF MOVEMENT (FIRST NUMBER)

For ease of instruction, drill commands have been broken down into individual movements, or numbers. The instructor(s) shall demonstrate and explain each number.

On the command QUICK MARCH BY NUMBERS, SQUAD – ONE, the cadet will execute the first number of march in quick time, by:

1. shooting the left foot forward one half pace, toe up;
2. striking the heel on the ground first and keeping the toe pointed directly forward; and
3. simultaneously, swinging the right arm straight forward and the left arm straight to the rear, waist high.

PRACTICE THE SQUAD ON THE FIRST MOVEMENT

Practice the squad on the first movement collectively, individually and collectively.



Constant checking and correcting of all faults is essential. Faults shall be corrected immediately after they occur.

DEMONSTRATE AND EXPLAIN THE SECOND PART OF THE MOVEMENT (SECOND NUMBER)

On the command SQUAD – TWO, the cadet shall execute the second number of the movement by:

1. continuing to march with subsequent paces of standard length;
2. bringing the legs forward successively in a straight line;
3. swinging the arms forward successively in a straight line from the shoulder, front to rear, with hands closed as in the position of attention; and
4. maintaining dressing by the directing flank.



The directing flank is the rank or file assigned by the commander as that from which the dressing is to be taken, when formed as a squad.

PRACTICE THE SQUAD ON THE SECOND MOVEMENT

Practice the squad on the second movement collectively, individually and collectively.

GIVE TWO COMPLETE AND FINAL DEMONSTRATIONS

On the command QUICK – MARCH, combine the two movements. The timing will be “left-right-left.”

The instructor(s) shall provide a full demonstration and allow time for practice.

Teaching Point 2**Halt in Quick Time**

Time: 15 min

Method: Demonstration and Performance

DEMONSTRATE THE COMPLETE MOVEMENT WITH TIMING

The instructor shall provide a complete demonstration of the drill movement, with timing. A practiced assistant instructor may carry out this demonstration.

The demonstration shall be provided from various vantage points, as required.

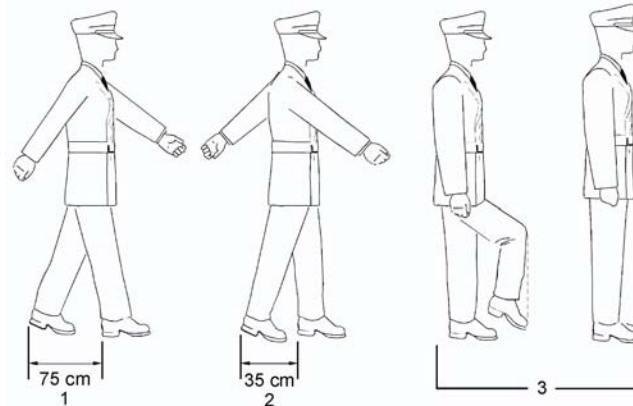

A-PD-201-000/PT-000, The Canadian Forces Manual of Drill and Ceremonial, 2001

Figure 8-8-2 Halting in Quick Time

DEMONSTRATE FIRST PART OF MOVEMENT (FIRST NUMBER)

On the command HALT BY NUMBERS, SQUAD – ONE, given as the left foot is forward and on the ground, the cadet shall execute the first number of the movement by:

1. checking the forward movement by placing the right foot flat on the ground naturally, using the heel as a brake; and
2. swinging the left arm forward and the right arm to the rear.

PRACTICE THE SQUAD ON THE FIRST MOVEMENT

Practice the squad on the first movement collectively, individually and collectively.

DEMONSTRATE AND EXPLAIN THE SECOND PART OF THE MOVEMENT (SECOND NUMBER)

On the command SQUAD – TWO, the cadet shall execute the second number of the movement by:

1. taking a half pace with the left foot, placing it flat on the ground; and
2. swinging the right arm forward and the left to the rear.

PRACTICE THE SQUAD ON THE SECOND MOVEMENT

Practice the squad on the second movement collectively, individually and collectively.

DEMONSTRATE AND EXPLAIN THE THIRD PART OF THE MOVEMENT (THIRD NUMBER)

On the command SQUAD – THREE, the cadet shall execute the third number of the movement by:

1. bending the right knee, straightening it in double time; and
2. simultaneously, cutting the arms to the side as quickly as possible and assuming the position of attention.

PRACTICE THE SQUAD ON THE THIRD MOVEMENT

Practice the squad on the third movement collectively, individually and collectively.

GIVE TWO COMPLETE AND FINAL DEMONSTRATIONS

On the command SQUAD – HALT, combine the three movements in quick time. The timing is called as “one, one-two”.

The instructor(s) shall provide a full demonstration and allow time for practice.

END OF LESSON CONFIRMATION

The confirmation for this lesson should consist of the cadets, as a squad, practicing marching and halting in quick time, and should emphasise movements that cadets showed difficulty with during the class.

Practice the complete movement with the:

- **instructor** calling the time;
- **squad** calling the time; and
- squad **judging** the time.

CONCLUSION

HOMEWORK/READING/PRACTICE

Drill movements are skills that must be practiced individually, in order to make the cadet more proficient as a member of a unit. Cadets are encouraged to practice the movements, as opportunities are made available. Ongoing feedback will be provided, and should be heeded during any drill practice.

METHOD OF EVALUATION

In accordance with A-PD-201-000/PT-000, *The Canadian Forces Manual of Drill and Ceremonial*, the cadet shall participate in an Annual Ceremonial Review (ACR) parade. This movement will be used in preparation for, and in the execution of, the ACR parade.

CLOSING STATEMENT

The hallmarks of cadet drill are efficiency, precision, and dignity. These qualities are developed through self-discipline and practice. They lead to unit pride and cohesion. Good drill, that is well rehearsed, closely supervised and precise, is an exercise in obedience and alertness. It sets the standard for the execution of any duty, both for the individual and the unit, and builds a sense of confidence between commander and subordinate that is essential to high morale. The personal qualities developed on the parade ground must be maintained in all aspects of cadet life.

INSTRUCTOR NOTES/REMARKS

N/A.

REFERENCES

- A0-002 A-PD-201-000/PT-000 DHH 3-2. (2001). *The Canadian Forces Manual of Drill and Ceremonial*. Ottawa, ON: The Department of National Defence.



COMMON TRAINING INSTRUCTIONAL GUIDE



SECTION 9

EO M108.09 – EXECUTE MARKING TIME, FORWARD, AND HALTING IN QUICK TIME

Total Time:

30 min

INTRODUCTION

PRE-LESSON INSTRUCTIONS

A complete list of resources needed for the instruction of this EO is located at Chapter 2 of the QSP. Specific uses for said stores are identified throughout the Instructional Guide, within the teaching point for which they are required.

Prior to instructing this lesson the instructor shall:

- review the lesson content, and become familiar with the material; and
- select the most effective squad formation for the lesson being taught. A squad may be in a single rank, hollow square or semi-circle for elementary drill instruction. (Note: All cadets **must** be able to fully observe all demonstrations and explanations.)

PRE-LESSON ASSIGNMENT

N/A.

APPROACH

This lesson will be presented using the demonstration and performance method. The demonstration and performance method was chosen to allow cadets to participate in supervised exploration of practical instructional material. This method provides the instructor the opportunity to introduce the subject matter, demonstrate and explain procedures, and supervise the cadets while they imitate the skill. This method appeals to all learning styles.



The instructor shall develop and use a vocabulary of short, concise words to impress on the squad that the movements must be performed smartly. For example, the words “crack”, “drive”, “seize” and “grasp” suggest the degree of smartness required. Profanity or personal sarcasm shall never be used.

REVIEW

The pertinent review for this lesson will include:

- EO M108.08 (Section 8).
- The instructor will have the squad march and halt in quick time until they can perform the movement without hesitation, and with ease.

OBJECTIVES

By the end of this lesson the cadet shall be expected to execute marking time, forward and halting in quick time.

IMPORTANCE

As members of the Canadian Cadet Movement (CCM) cadets will be required to perform drill movements at a competent level, developing sharpness, esprit de corps, physical coordination, and alertness. These movements will be executed with ease and without hesitation. Ensuring that the cadets efficiently move together as one will promote discipline, alertness, precision, pride, steadiness, and cohesion. This develops the basis of teamwork that the CCM depends on.

Teaching Point 1

Execute Marking Time

Time: 9 min

Method: Demonstration and Performance

DEMONSTRATE THE COMPLETE MOVEMENT WITH TIMING



Instructors are reminded that they are to present the example with regards to drill, from the moment they step onto the parade square. Proper drill movements, combined with a professional demeanour, are of paramount importance and must be exemplified throughout the period of instruction.

The instructor shall provide a complete demonstration of the drill movement, with timing. A practiced assistant instructor may carry out this demonstration.

The demonstration shall be provided from various vantage points, as required.

Marking time is executed when a cadet is required to cease forward motion for a short period of time, while on the march. Marking time is carried out at the same cadence as for marching. Only the legs are moved and the upper portion of the body remains in the position of attention with arms at the side.

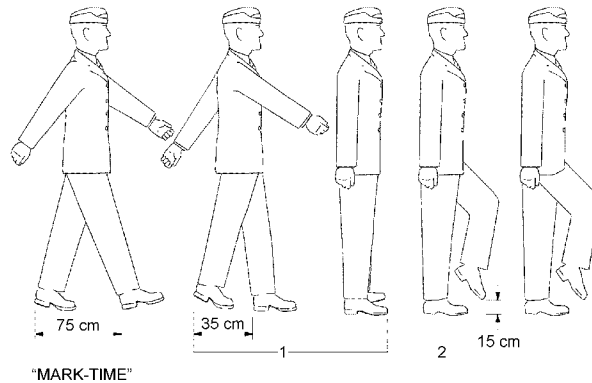

A-PD-201-000/PT-000, *The Canadian Forces Manual of Drill and Ceremonial*, 2001

Figure 8-9-1 Marking Time in Quick Time

DEMONSTRATE AND EXPLAIN THE FIRST PART OF MOVEMENT (FIRST NUMBER)

For ease of instruction, drill commands have been broken down into individual movements, or numbers. The instructor(s) shall demonstrate and explain each number.

On the command MARK TIME BY NUMBERS, SQUAD – ONE, given as the right foot is forward on the ground, the cadet shall execute the first number of the movement by:

1. taking a half pace with the left foot, placing the foot flat on the ground naturally;
2. maintaining the same cadence, bringing the right foot into the left in a straight leg manner, not scraping the ground;
3. simultaneously, cutting the arms to the sides and assuming the position of attention; and
4. maintaining the same cadence.

PRACTICE THE SQUAD ON THE FIRST MOVEMENT

Practice the squad on the first movement collectively, individually and collectively.



Constant checking and correcting of all faults is essential. Faults shall be corrected immediately after they occur.

DEMONSTRATE AND EXPLAIN THE SECOND PART OF THE MOVEMENT (SECOND NUMBER)

On the command SQUAD – TWO, the cadet shall execute the second number by:

1. bending the left knee so that the thigh is parallel to the ground and the foot at a natural angle;
2. placing the toe on the ground before the heel as the leg is lowered; and
3. continuing to mark time until the command FOR – WARD or HALT is given.

PRACTICE THE SQUAD ON THE SECOND MOVEMENT

Practice the squad on the second movement collectively, individually and collectively.

GIVE TWO COMPLETE AND FINAL DEMONSTRATIONS

On the command MARK – TIME, combine the two movements. Utilize the timing: “left – in – left – right – left”.

The instructor(s) shall provide a full demonstration and allow time for practice.

Teaching Point 2**Execute Forward From Marking Time**

Time: 9 min

Method: Demonstration and Performance

DEMONSTRATE THE COMPLETE MOVEMENT WITH TIMING

This movement cannot be broken down into squads, as it is best learned as a complete movement.

The instructor shall provide a complete demonstration of the drill movement, with timing. A practiced assistant instructor may carry out this demonstration.

The demonstration shall be provided from various vantage points, as required.

On the command FOR – WARD, given as the left foot is on the ground, the cadet shall carry on marching forward, from the mark time by:

1. straightening the right leg and assuming the position of attention;
2. shooting the left foot forward in a half pace; and
3. continuing to march in quick time, swinging the right arm forward and the left to the rear.

GIVE TWO COMPLETE AND FINAL DEMONSTRATIONS

On the command MARK – TIME, combine the two movements. Utilize the timing: “left – in – left – right – left”.

The instructor(s) shall provide a full demonstration and allow time for practice.

Teaching Point 3**Execute Halting in Quick Time From Marking Time**

Time: 7 min

Method: Demonstration and Performance

DEMONSTRATE THE COMPLETE MOVEMENT WITH TIMING

This movement cannot be broken down into squads, as it is best learned as a complete movement.

The instructor shall provide a complete demonstration of the drill movement, with timing. A practiced assistant instructor may carry out this demonstration.

The demonstration shall be provided from various vantage points, as required.

On the command SQUAD – HALT, given as the left foot is on the ground, the cadet will halt, from the mark time by:

1. taking a further mark time pace with the right foot;
2. taking a further mark time pace with the left foot; and
3. straightening the right leg in double time and assuming the position of attention, utilizing the timing: “one, one-two”.

GIVE TWO COMPLETE AND FINAL DEMONSTRATIONS

On the command MARK – TIME, combine the two movements. Utilize the timing: “left – in – left – right – left”.

The instructor(s) shall provide a full demonstration and allow time for practice.

END OF LESSON CONFIRMATION

The confirmation for this lesson should consist of the cadets, as a squad, practicing marking time, forward from marking time, and halting in quick time. Instructors should emphasise movements that cadets showed difficulty with during the class.

Practice the complete movement with the:

- **instructor** calling the time;
- **squad** calling the time; and
- squad **judging** the time.

CONCLUSION

HOMEWORK/READING/PRACTICE

Drill movements are skills that must be practiced individually, in order to make the cadet more proficient as a member of a unit. Cadets are encouraged to practice the movements, as opportunities are made available. Ongoing feedback will be provided, and should be heeded during any drill practice.

METHOD OF EVALUATION

In accordance with A-PD-201-000/PT-000, *The Canadian Forces Manual of Drill and Ceremonial*, the cadet shall participate in an Annual Ceremonial Review (ACR) parade. This movement will be used in preparation for, and in the execution of, the ACR parade.

CLOSING STATEMENT

The hallmarks of cadet drill are efficiency, precision, and dignity. These qualities are developed through self-discipline and practice. They lead to unit pride and cohesion. Good drill, that is well rehearsed, closely supervised and precise, is an exercise in obedience and alertness. It sets the standard for the execution of any duty, both for the individual and the unit, and builds a sense of confidence between commander and subordinate that is essential to high morale. The personal qualities developed on the parade ground must be maintained in all aspects of cadet life.

INSTRUCTOR NOTES/REMARKS

N/A.

REFERENCES

- A0-002 A-PD-201-000/PT-000 DHH 3-2. (2001). *The Canadian Forces Manual of Drill and Ceremonial*. Ottawa, ON: The Department of National Defence.

THIS PAGE INTENTIONALLY LEFT BLANK



COMMON TRAINING INSTRUCTIONAL GUIDE



SECTION 10

EO M108.10 – EXECUTE A SALUTE ON THE MARCH

Total Time:

30 min

INTRODUCTION

PRE-LESSON INSTRUCTIONS

A complete list of resources needed for the instruction of this EO is located at Chapter 2 of the QSP. Specific uses for said stores are identified throughout the Instructional Guide, within the teaching point for which they are required.

Prior to instructing this lesson the instructor shall:

- review the lesson content, and become familiar with the material; and
- select the most effective squad formation for the lesson being taught. A squad may be in a single rank, hollow square or semi-circle for elementary drill instruction. (Note: All cadets **must** be able to fully observe all demonstrations and explanations.)

PRE-LESSON ASSIGNMENT

N/A.

APPROACH

This lesson will be presented using the demonstration and performance method. The demonstration and performance method was chosen to allow cadets to participate in supervised exploration of practical instructional material. This method provides the instructor the opportunity to introduce the subject matter, demonstrate and explain procedures, and supervise the cadets while they imitate the skill. This method appeals to all learning styles.



The instructor shall develop and use a vocabulary of short, concise words to impress on the squad that the movements must be performed smartly. For example, the words “crack”, “drive”, “seize” and “grasp” suggest the degree of smartness required. Profanity or personal sarcasm shall never be used.

REVIEW

The pertinent review for this lesson will include:

- EO M108.08 (Section 8).
- The instructor will have the squad march, and halt in quick time until they can perform the movement without hesitation and with ease.

OBJECTIVES

By the end of this lesson the cadet shall be expected to execute a salute on the march.

IMPORTANCE

As members of the Canadian Cadet Movement (CCM) cadets will be required to perform drill movements at a competent level, developing sharpness, esprit de corps, physical coordination, and alertness. These movements will be executed with ease and without hesitation. Ensuring that the cadets efficiently move together as one will promote discipline, alertness, precision, pride, steadiness, and cohesion. This develops the basis of teamwork that the CCM depends on.

Teaching Point 1

Execute Saluting on the March

Time: 15 min

Method: Demonstration and Performance

DEMONSTRATE THE COMPLETE MOVEMENT WITH TIMING



Instructors are reminded that they are to present the example with regards to drill, from the moment they step onto the parade square. Proper drill movements, combined with a professional demeanour, are of paramount importance, and must be exemplified throughout the period of instruction.

The instructor shall provide a complete demonstration of the drill movement, with timing. A practiced assistant instructor may carry out this demonstration.

The demonstration shall be provided from various vantage points, as required.

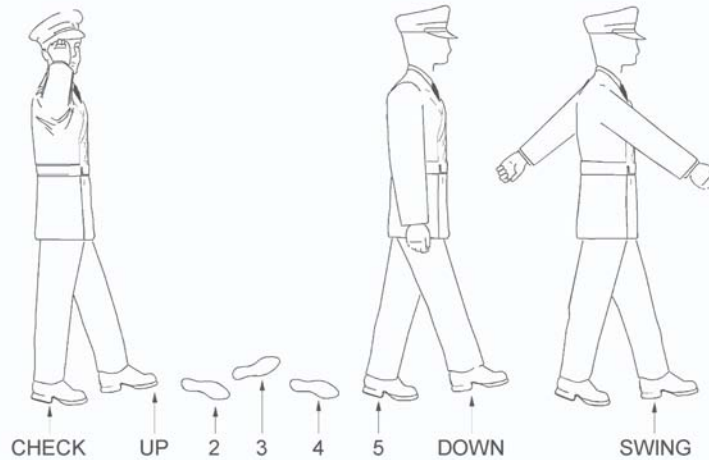

A-PD-201-000/PT-000, *The Canadian Forces Manual of Drill and Ceremonial*, 2001

Figure 8-10-1 Saluting on the March

DEMONSTRATE FIRST PART OF MOVEMENT (FIRST NUMBER)

For ease of instruction, drill commands have been broken down into individual movements, or numbers. The instructor(s) shall demonstrate and explain each number.

On the command TO THE RIGHT (LEFT) SALUTE BY NUMBERS, SQUAD – ONE, given as the left foot is forward and on the ground, the cadet shall execute the first number by:

1. completing the next pace with the right foot; and
2. swinging the left arm forward and the right arm to the rear normally.

PRACTICE THE SQUAD ON THE FIRST MOVEMENT

Practice the squad on the first movement collectively, individually and collectively.



Constant checking and correcting of all faults is essential. Faults shall be corrected immediately after they occur.

DEMONSTRATE AND EXPLAIN THE SECOND PART OF THE MOVEMENT (SECOND NUMBER)

On the command SQUAD – TWO, the cadet shall execute the second number by:

1. completing the next pace with the left foot;
2. cutting the left arm to the side; and
3. cutting the right arm forward to the side and then up into the salute in one continuous movement.

PRACTICE THE SQUAD ON THE SECOND MOVEMENT

Practice the squad on the second movement collectively, individually and collectively.

DEMONSTRATE AND EXPLAIN THE THIRD PART OF THE MOVEMENT (THIRD NUMBER)

On the command SQUAD – THREE, the cadet shall complete four paces in quick time, ending with the left foot forward.

PRACTICE THE SQUAD ON THE THIRD MOVEMENT

Practice the squad on the third movement collectively, individually and collectively.

DEMONSTRATE AND EXPLAIN THE FOURTH PART OF THE MOVEMENT (FOURTH NUMBER)

On the command SQUAD – FOUR, the cadet shall execute the fourth number by:

1. completing a pace with the right foot; and
2. cutting the right arm to the side.

PRACTICE THE SQUAD ON THE FOURTH MOVEMENT

Practice the squad on the fourth movement collectively, individually and collectively.

DEMONSTRATE AND EXPLAIN THE FIFTH PART OF THE MOVEMENT (FIFTH NUMBER)

On the command SQUAD – FIVE, the cadet shall continue to march.

PRACTICE THE SQUAD ON THE FIFTH MOVEMENT

Practice the squad on the fifth movement collectively, individually and collectively.

GIVE TWO COMPLETE AND FINAL DEMONSTRATIONS

On the command TO THE RIGHT (LEFT) – SALUTE, the movements and combined, and the timing, “check – up – two – three – four– five – down – swing”, is utilized.

The instructor(s) shall provide a full demonstration and allow time for practice.

Teaching Point 2

Practice Saluting on the March

Time: 10 min

Method: Demonstration and Performance



While saluting, the head is turned right (left) as far as possible without straining.

On the command TO THE RIGHT (LEFT) – SALUTE, the movements are combined, and the timing, CHECK – UP – TWO – THREE – FOUR– FIVE – DOWN – SWING, is utilized.



Note: This movement requires much practice as a formed body, and the instructor is encouraged to fully utilize this time for said practice.

END OF LESSON CONFIRMATION

The confirmation for this lesson should consist of the cadets, as a squad, practicing saluting on the march (**right and left**), and should emphasise movements that cadets showed difficulty with during the class.

Practice the complete movement with the:

- **instructor** calling the time;
- **squad** calling the time; and
- squad **judging** the time.

CONCLUSION

HOMEWORK/READING/PRACTICE

Drill movements are skills that must be practiced individually, in order to make the cadet more proficient as a member of a unit. Cadets are encouraged to practice the movements, as opportunities are made available. Ongoing feedback will be provided, and should be heeded during any drill practice.

METHOD OF EVALUATION

In accordance with A-PD-201-000/PT-000, *The Canadian Forces Manual of Drill and Ceremonial*, the cadet shall participate in an Annual Ceremonial Review (ACR) parade. This movement will be used in preparation for, and in the execution of, the ACR parade.

CLOSING STATEMENT

The hallmarks of cadet drill are efficiency, precision, and dignity. These qualities are developed through self-discipline and practice. They lead to unit pride and cohesion. Good drill, that is well rehearsed, closely supervised and precise, is an exercise in obedience and alertness. It sets the standard for the execution of any duty, both for the individual and the unit, and builds a sense of confidence between commander and subordinate that is essential to high morale. The personal qualities developed on the parade ground must be maintained in all aspects of cadet life.

INSTRUCTOR NOTES/REMARKS

N/A.

REFERENCES

A0-002 A-PD-201-000/PT-000, DHH 3-2. (2001). *The Canadian Forces Manual of Drill and Ceremonial*. Ottawa, ON: The Department of National Defence.

THIS PAGE INTENTIONALLY LEFT BLANK



COMMON TRAINING INSTRUCTIONAL GUIDE



SECTION 11

EO M108.11 – PAY COMPLIMENTS WITH A SQUAD ON THE MARCH

Total Time:

30 min

INTRODUCTION

PRE-LESSON INSTRUCTIONS

A complete list of resources needed for the instruction of this EO is located at Chapter 2 of the QSP. Specific uses for said stores are identified throughout the Instructional Guide, within the teaching point for which they are required.

Prior to instructing this lesson the instructor shall:

- review the lesson content, and become familiar with the material; and
- select the most effective squad formation for the lesson being taught. A squad may be in a single rank, hollow square or semi-circle for elementary drill instruction. (Note: All cadets **must** be able to fully observe all demonstrations and explanations.)

PRE-LESSON ASSIGNMENT

N/A.

APPROACH

This lesson will be presented using the demonstration and performance method. The demonstration and performance method was chosen to allow cadets to participate in supervised exploration of practical instructional material. This method provides the instructor the opportunity to introduce the subject matter, demonstrate and explain procedures, and supervise the cadets while they imitate the skill. This method appeals to all learning styles.



The instructor shall develop and use a vocabulary of short, concise words to impress on the squad that the movements must be performed smartly. For example, the words “crack”, “drive”, “seize” and “grasp” suggest the degree of smartness required. Profanity or personal sarcasm shall never be used.

REVIEW

The pertinent review for this lesson will include:

- EO M108.10 (Section 10).
- The instructor will have the squad salute on the march until they can perform the movement without hesitation and with ease.

OBJECTIVES

By the end of this lesson the cadet shall be expected to pay compliments as a member of a squad on the march.

IMPORTANCE

As members of the Canadian Cadet Movement (CCM) cadets will be required to perform drill movements at a competent level, developing sharpness, esprit de corps, physical coordination, and alertness. These movements will be executed with ease and without hesitation. Ensuring that the cadets efficiently move together as one will promote discipline, alertness, precision, pride, steadiness, and cohesion. This develops the basis of teamwork that the CCM depends on.

Teaching Point 1

Execute Eyes Right (Left) To Pay Compliments on the March

Time: 15 min

Method: Demonstration and Performance

DEMONSTRATE THE COMPLETE MOVEMENT WITH TIMING



Instructors are reminded that they are to present the example with regards to drill, from the moment they step onto the parade square. Proper drill movements, combined with a professional demeanour, are of paramount importance, and must be exemplified throughout the period of instruction.

The instructor shall provide a complete demonstration of the drill movement, with timing. A practiced assistant instructor may carry out this demonstration.

The demonstration shall be provided from various vantage points, as required.

As a member of a squad, cadets will be required to pay compliments. While marching as a member of a squad, cadets shall not salute from within the ranks, but shall turn the head in the direction of the person or object to which compliments are being paid when the command is called.

DEMONSTRATE THE MOVEMENT

On the command EYES – RIGHT (LEFT), given as the left foot is forward and on the ground, the cadet shall pay compliments on the march as a member of a squad by:

1. completing the next pace forward with the right foot;
2. as the left foot comes forward again and strikes the ground, turning the head and eyes to the right (left) as far as possible without straining and looking directly into the eyes of the personage being saluted;
3. continuing to swing the arms; and
4. maintaining dressing, direction, and cadence, while continuing to march.

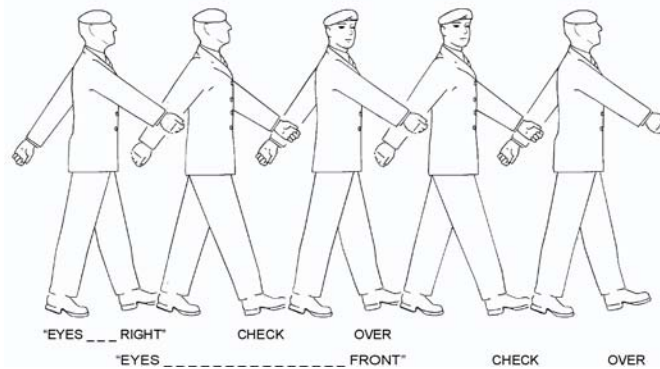

A-PD-201-000/PT-000, *The Canadian Forces Manual of Drill and Ceremonial, 2001*

Figure 8-11-1 Eyes Right on the March



The leading person on the directing flank shall maintain head and eyes to the front to keep direction.



The person in command of the squad shall salute.

PRACTICE THE SQUAD ON THE MOVEMENT

Practice the squad on the movement collectively, individually and collectively.



Constant checking and correcting of all faults is essential. Faults shall be corrected immediately after they occur.

Teaching Point 2

Time: 10 min

Execute Eyes Front While on the March

Method: Demonstration and Performance

DEMONSTRATE THE COMPLETE MOVEMENT WITH TIMING

The instructor shall provide a complete demonstration of the drill movement, with timing. A practiced assistant instructor may carry out this demonstration.

The demonstration shall be provided from various vantage points, as required.

Once the proper compliment has been paid, the cadets will be required to return the head to a forward facing direction.

DEMONSTRATE THE MOVEMENT

The cadet shall return the head to the front on the command EYES – FRONT, given as the left foot is forward and on the ground, by:

1. completing the next pace forward with the right foot; and
2. as the left foot comes forward and strikes the ground, cutting the head and eyes smartly to the front.



The person in command of the squad completes the salute on the right foot by checking the arms to their sides, simultaneously turning the head to a forward facing direction, and commences to swing the arms on the following pace with the left foot.

PRACTICE THE SQUAD ON THE MOVEMENT

Practice the squad on the movement collectively, individually and collectively.

END OF LESSON CONFIRMATION

The confirmation for this lesson should consist of the cadets, as a squad, practicing paying compliments on the march to the right and left, and should emphasise movements that cadets showed difficulty with during the class.

Practice the complete movement, with the:

- **instructor** calling the time;
- **squad** calling the time; and
- squad **judging** the time.

CONCLUSION

HOMEWORK/READING/PRACTICE

Drill movements are skills that must be practiced individually, in order to make the cadet more proficient as a member of a unit. Cadets are encouraged to practice the movements, as opportunities are made available. Ongoing feedback will be provided, and should be heeded during any drill practice.

METHOD OF EVALUATION

In accordance with A-PD-201-000/PT-000, *The Canadian Forces Manual of Drill and Ceremonial*, the cadet shall participate in an Annual Ceremonial Review (ACR) parade. This movement will be used in preparation for, and in the execution of, the ACR parade.

CLOSING STATEMENT

The hallmarks of cadet drill are efficiency, precision, and dignity. These qualities are developed through self-discipline and practice. They lead to unit pride and cohesion. Good drill, that is well rehearsed, closely supervised and precise, is an exercise in obedience and alertness. It sets the standard for the execution of any duty, both for the individual and the unit, and builds a sense of confidence between commander and subordinate that is essential to high morale. The personal qualities developed on the parade ground must be maintained in all aspects of cadet life.

INSTRUCTOR NOTES/REMARKS

N/A.

REFERENCES

A0-002 A-PD-201-000/PT-000, DHH 3-2. (2001). *The Canadian Forces Manual of Drill and Ceremonial*. Ottawa, ON: The Department of National Defence.

THIS PAGE INTENTIONALLY LEFT BLANK



COMMON TRAINING INSTRUCTIONAL GUIDE



SECTION 12

EO M108.CA – PARTICIPATE IN AN ANNUAL CEREMONIAL REVIEW PARADE

Total Time:

90 min

INTRODUCTION

PRE-LESSON INSTRUCTIONS

A complete list of resources needed for the instruction of this EO is located at Chapter 2 of the QSP. Specific uses for said stores are identified throughout the Instructional Guide, within the teaching point for which they are required.

Prior to the instruction of this lesson the instructor shall:

- review the lesson content, and become familiar with the material prior to instruction of this lesson;
- ensure suitable practice time has been allotted in the weeks preceding the Annual Ceremonial Review (ACR) parade, in accordance with the format provided at Annexes A through D; and
- ensure the words of command are provided to the respective parade appointments in the weeks preceding the ACR parade.

PRE-LESSON ASSIGNMENT

Prior to the lesson, the cadet shall have completed:

- all mandatory EOs in PO 108, ensuring the movements are well rehearsed IAW A-PD-201-000/PT-000, *The Canadian Forces Manual of Drill and Ceremonial*;
- any additional training required to bring personal drill to the standard laid out in A-PD-201-000/PT-000, *The Canadian Forces Manual of Drill and Ceremonial*; and
- individual assistance as required.

APPROACH

The experiential method was chosen to allow cadets to develop knowledge and skills through a process whereby concepts are derived from, and continuously modified by, their own experience. The experiential method combines a short initial activity briefing, a structured or semi-structured activity, and a reflective group discussion. The instructor supervises the activity and then leads a group discussion to encourage reflection and make connections between the experience and future applications of the learning outcomes. This method appeals to tactile/kinaesthetic learners.

REVIEW

N/A.

OBJECTIVES

Upon completion of EO M108.CA the cadet shall be expected to perform all drill movements required for, and have participated in, an ACR parade.

IMPORTANCE

As members of the Canadian Cadet Movement (CCM) cadets will be required to perform drill movements at a competent level, developing sharpness, esprit de corps, physical coordination, and alertness. These movements will be executed with ease and without hesitation. Ensuring that the cadets move efficiently and as one will promote discipline, alertness, precision, pride, steadiness, and cohesion. This develops the basis of teamwork that the CCM depends on.

ACTIVITY

Time: 90 min

OBJECTIVE

This activity is intended to confirm the ability of a year one cadet to participate fully in an ACR parade. It involves all of the mandatory drill movements taught throughout PO 108, combined in a cadet specific review format.

RESOURCES

- Parade area suitable for conduct of an ACR parade.
- Parade markers used in establishing the parade area IAW A-PD-201-000/PT-000, *The Canadian Forces Manual of Drill and Ceremonial*.

ACTIVITY LAYOUT

This activity will be conducted in accordance with Annexes A through D.

SAFETY

This activity will be conducted under supervision.

INSTRUCTOR GUIDELINES

The instructor shall supervise all aspects of the preparation and execution of this confirmation activity. It is the responsibility of the instructor, in accordance with direction from the squadron CO, to amend the parade format found at Annexes A through D, to match the individual requirements of the squadron and the community. These amendments may include, though are not limited to; the addition of demonstrations and displays, the addition of squadron traditions and/or affiliated unit procedures, and the addition of community involvement. These augmentations are not to compromise the professional appearance of the parade.

END OF LESSON CONFIRMATION

N/A.

CONCLUSION

HOMEWORK/READING/PRACTICE

N/A.

METHOD OF EVALUATION

This lesson acts as the confirmation activity for PO 108. The execution of the parade will allow the instructor to observe and confirm the cadets' ability to perform the required movements and procedures.

CLOSING STATEMENT

The ACR parade is the opportunity for cadet squadrons to showcase their year of training and, specifically, to demonstrate their grasp of the drill required to participate in a professional, military style parade.

INSTRUCTOR NOTES/REMARKS

1. Each year cadet squadrons are required to conduct an ACR parade. In the year one training programme, this requirement is included as the confirmation activity for PO 108 (EO M108.CA).
2. These guidelines are provided to assist the instructor in presentation of EO M108.CA, ensuring the requirements of A-PD-201-000/PT-000, *The Canadian Forces Manual of Drill and Ceremonial*, are met, while also recognizing the unique nature of the cadet squadron structure.
3. These guidelines provide the basic requirements to allow a cadet squadron to execute an ACR parade, and will meet the needs of the majority of cadet squadrons.
4. Squadrons are not required to parade a Flag Party, however; cadet specific instructions have been provided at Annex C for those squadrons choosing to include flags as part of the ACR parade. Annex C details the procedure for falling in and falling out a Flag Party to assist flag parties in their preparation, and Annex D includes complete Flag Party instructions, inserted at the appropriate points in the parade sequence.
5. These guidelines are presented in several annexes intended to capture most accurately the requirements of various squadron compositions. Initially, the squadron will have to determine if they have sufficient numbers to warrant parading a flight (effective parade strength of less than 32 cadets), or if the parade strength calls for the parading of a squadron (two or more flights and a parade strength of 45 cadets or more). When the squadron is parading between 32 and 45 cadets, the instructor shall determine the appropriate formation for their circumstances.
6. Below is a list of annexes provided within these guidelines. The instructor shall review the annexes and, in consultation with the squadron CO, select an applicable formation and a review format that best suits the needs of the squadron.
 - Annex A, General Outline and Ordering a Flight on Parade.
 - Annex B, Forming Up a Squadron.
 - Annex C, Marching On and Marching Off of the Flags.
 - Annex D, Annual Ceremonial Review Parade Sequence of Events.

REFERENCES

- A0-002 A-PD-201-000/PT-000 DHH 3-2. (2001). *The Canadian Forces Manual of Drill and Ceremonial*. Ottawa, ON: The Department of National Defence.

THIS PAGE INTENTIONALLY LEFT BLANK



ROYAL CANADIAN ARMY CADETS

GREEN STAR

INSTRUCTIONAL GUIDE



SECTION 13

EO C108.01 – EXECUTE SUPPLEMENTARY DRILL MOVEMENTS

Total Time: 180 min

No Instructional Guide is provided for this EO, refer to A-PD-201-000/PT-000, *The Canadian Forces Manual of Drill and Ceremonial*, Chapter 2 or 3, for approved supplementary drill periods.

THIS PAGE INTENTIONALLY LEFT BLANK



ROYAL CANADIAN ARMY CADETS

GREEN STAR

INSTRUCTIONAL GUIDE



SECTION 14

EO C108.02 – PARTICIPATE IN A DRILL COMPETITION

Total Time:

90 min

INTRODUCTION

PRE-LESSON INSTRUCTIONS

The instructor shall review the lesson content, and become familiar with the material prior to instruction of this lesson.

A complete list of resources needed for the instruction of this EO is located at Chapter 2 of the QSP. Specific uses for said stores are identified throughout the Instructional Guide, within the teaching point for which they are required.

PRE-LESSON ASSIGNMENT

Cadets are to have completed all mandatory EOs associated with PO 108 prior to participating in a drill competition.

APPROACH

This lesson will be presented using the performance method. The performance method was chosen to allow cadets to participate in supervised exploration of practical instructional material. This method appeals to all learning styles.

REVIEW

The movements associated with EO M108.CA (Section 12) will be reviewed by the assigned team captain, and shall correspond with the movements associated with the drill competition.

OBJECTIVES

This complementary package is intended to encourage the cadets to gain an interest in PO 108 while providing a venue for friendly competition within a controlled environment. This activity will encourage cadets to continue to practice the movements on their own, leading to eventual improvement of the squadron's drill.

IMPORTANCE

To ensure cadets efficiently march and manoeuvre together as one, this activity promotes; discipline, alertness, precision, pride, steadiness and cohesion.

ACTIVITY – DRILL COMPETITION

Time: 90 min

OBJECTIVE

To ensure cadets efficiently march and manoeuvre together as one, thereby promoting discipline, alertness, precision, pride, steadiness and cohesion.

RESOURCES

- Parade square, of suitable size to allow for execution of the required movements.
- Uniforms and accoutrements.
- One stopwatch.
- Masking tape.
- Tables and chairs for the judges.
- Portable hand counters.

ACTIVITY LAYOUT

This activity is described in detail in Annex E of this document.

SAFETY

This activity is to be supervised.

INSTRUCTOR GUIDELINES

The activity instructional break down is explained in detail in Annex E.

END OF LESSON CONFIRMATION

The confirmation for this lesson will be effectively completed through the drill competition.

CONCLUSION

HOMEWORK/READING/PRACTICE

N/A.

METHOD OF EVALUATION

This lesson will be evaluated through a drill competition. The competition will be assessed in accordance with the evaluation forms located in Annex E, Appendix 3.

CLOSING STATEMENT

This complementary package is intended to encourage the cadets to gain an interest in PO 108, while providing a venue for friendly competition within a controlled environment. This activity will encourage cadets to continue to practice the movements on their own, leading to eventual improvement of the squadron's drill.

INSTRUCTOR NOTES/REMARKS

N/A.

REFERENCES

A0-002 A-PD-201-000/PT-000 DHH 3-2. (2001). *The Canadian Forces Manual of Drill and Ceremonial*. Ottawa, ON: The Department of National Defence.

THIS PAGE INTENTIONALLY LEFT BLANK

ORDERING A FLIGHT ON PARADE

Reference: A0-002 A-PD-201-000/PT-000 DHH 3-2. (2001). *The Canadian Forces Manual of Drill and Ceremonial*. Ottawa, ON: The Department of National Defence.

This formation should be implemented when there is an effective parade strength of less than 32 cadets.

1. Flight in Line

Reference: A0-002 Chapter 7, paragraph 7.

Regardless of its frontage, when a flight is formed in line, the Flight Commander (F Comd) shall be positioned three paces in front and centred on the flight, and the Flight Sergeant (F Sgt) shall be positioned three paces in rear and centred on the flight (Figure 8A2-1).

2. Steps to Ordering a Flight on Parade

Reference: A0-002 Chapter 7, paragraphs 12 to 15.

A flight is ordered on parade in a similar manner to falling in a squad:

- a. Prior to being fallen in on parade, the flight shall form in three ranks at the edge of the parade ground and stand at ease.
 - b. The F Sgt shall designate the right-hand person of the front rank as the marker.
 - c. The F Sgt shall then proceed unto the parade ground and halt three paces in front of where the marker is to fall.
 - d. The F Sgt shall then carry on with the directions detailed at Annex A, Appendix 1, Items 1 to 10.
 - e. Cadets filling the positions of supernumerary officers, WOs and senior NCOs act as follows:
 - (1) The WOs and senior NCOs will form up in a supernumerary rank, three paces behind the rear rank, evenly spaced across the flight frontage. They will act on the orders of the F Sgt.
 - (2) Those acting as supernumerary officers will be ordered to fall in by the F Comd after assuming command, as in squadron drill.
3. The flight shall be handed over to the F Comd in the following manner, and in accordance with directions detailed at Annex A, Appendix 1, Items 11 to 13:
- a. The F Sgt calls the flight to attention as the F Comd approaches.
 - b. The F Comd halts two paces in front of the F Sgt, who reports the strength, condition, etc. of the flight.
 - c. Upon being ordered to fall in, the F Sgt turns right and proceeds by a series of wheels around the right flank to take up his position in rear of the flight.
 - d. The F Comd marches forward two paces to take up his position.
 - e. The F Comd stands the parade at ease once the F Sgt has occupied the proper position.

Note: The flight formations shall be utilized when the squadron has an established strength of 32 or less cadets.

The two flight formations utilized are:

- Flight in Line (Figure 8A2-1); and
- Flight in Column of Route (Figure 8A2-2).

THIS PAGE INTENTIONALLY LEFT BLANK

ORDERING A FLIGHT ON PARADE

Item	Command	By	Action	Remarks
1.		F Sgt	The F Sgt shall march to a position three paces in front of, and facing, the position the marker is to occupy.	The flight is formed up in a position just off the parade ground, standing easy. The right-hand cadet of the front rank is the designated "marker".
2.	Marker	F Sgt	The marker shall come to attention, answer by rank, and observe the standard pause before marching in a direct line to, and halting three paces in front of and facing, the F Sgt. The marker shall remain at attention.	The flight shall come to the position of stand at ease. The F Sgt, after placing the marker, shall turn right and march to a position three paces in front of and centre facing where the formation shall fall in.
3.	Flight FALL – IN	F Sgt	Formation shall come to attention, observe the standard pause and march onto the parade ground. It shall halt on the left of and covering off the marker and remain at attention.	A direct route shall be taken by the formation. The F Sgt may wish to call the halt with less experienced groups.
4.	OPEN ORDER – MARCH	F Sgt	The flight acts as ordered. The F Sgt maintains the proper distance from the front rank by taking three half paces to the rear.	When formed in three ranks, the front rank takes three half paces forward, and the rear rank three half paces rearward. When in two ranks the rear rank takes three half paces rearward, and the front rank stands fast.
5.	RIGHT – DRESS	F Sgt	The flight acts as ordered. The F Sgt shall step off, marching and wheeling until six paces to the right of the right flank, facing the front and in line with the front rank. There the F Sgt shall halt. The F Sgt then turns left, and dresses the front rank.	F Comd not yet on parade.
6.	FRONT RANK STEADY	F Sgt	Turns left, and, keeping the arms at the side, paces off the interval, halts, turns right, and dresses the centre rank.	
7.	CENTRE RANK STEADY	F Sgt	Turns left, and, keeping the arms at the side, paces off the interval, halts, turns right, and dresses the rear rank.	

Item	Command	By	Action	Remarks
8.	REAR RANK STEADY	F Sgt	The flight warrant steps off and, by a series of wheels, adopts the position three paces in front of, and centred on the flight.	
9.	EYES – FRONT	F Sgt	The flight acts as ordered.	Ordered by the F Sgt after returning to the position in front of the flight.
10.	STAND AT – EASE	F Sgt	The flight acts as ordered. The F Sgt turns about, faces the front, and stands at ease.	F Sgt awaits the arrival of the F Comd.
11.	ATTEN – TION	F Sgt	The flight acts as ordered. The F Sgt, on seeing the F Comd approach, shall come to attention, turn about and face the flight to give the order. The F Sgt shall turn and face the front once the order is carried out.	Given as the F Comd approaches.
12.			The F Comd shall halt two paces in front of the F Sgt. The F Sgt shall salute and report the flight. On completion of reporting, the F Comd shall order the F Sgt to fall in. The F Sgt shall turn right and move to the assigned parade position, moving around the right flank of the flight.	The F Sgt shall, by a series of wheels, adopt the position three paces to the rear of the flight in line with F Comd. The F Comd shall take two paces forward to the position vacated by the F Sgt and wait until the F Sgt is in position prior to issuing additional orders.
13.	FLIGHT STAND AT – EASE	F Comd	The flight acts as ordered.	The F Comd carries on inspecting the flight or proceeding with training or ACR parade format as assigned.
<p>Note: The formations used are as follows:</p> <ul style="list-style-type: none"> • <i>five or fewer form up in a single rank;</i> • <i>six to nine form up in two ranks; and</i> • <i>ten or more form up in three ranks.</i> 				

FLIGHT IN LINE AND FLIGHT IN COLUMN OF ROUTE DIAGRAMS

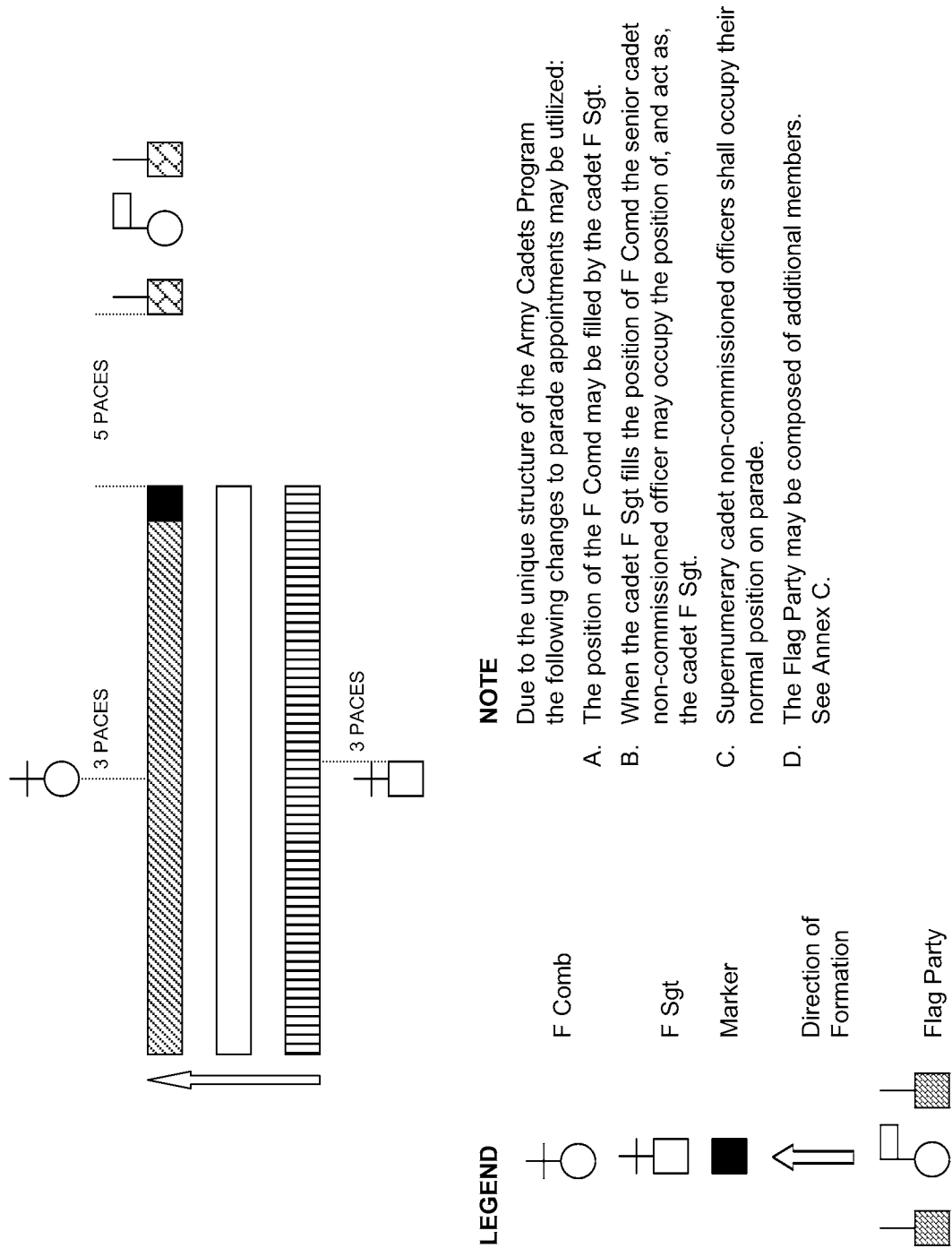
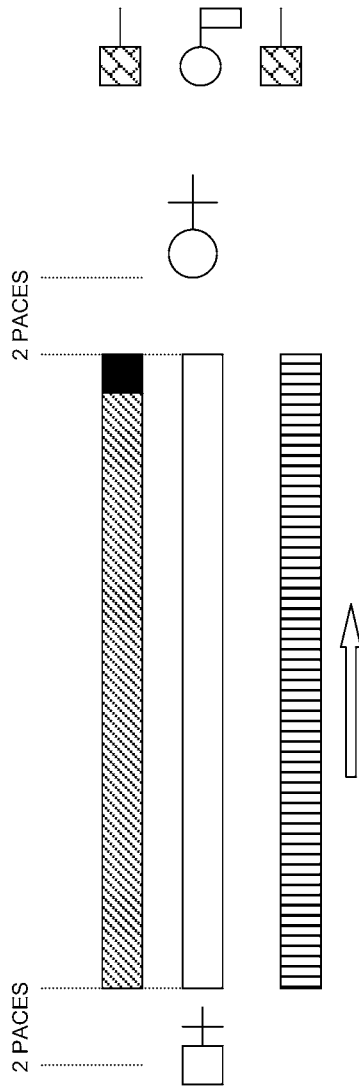







Figure 8A2-1 Flight in Line



LEGEND

-  F Comb
-  F Sgt
-  Marker
-  Direction of Formation
-  Flag Party

NOTE

Due to the unique structure of the Army Cadets Program the following changes to parade appointments may be utilized:

- A. The position of the F Comb may be filled the cadet F Sgt.
- B. When the cadet F Sgt fills the position of F Comb the senior cadet non-commissioned officer may occupy the position of, and act as, the cadet F Sgt.
- C. Supernumerary cadet non-commissioned officers shall occupy their normal position on parade.
- D. The Flag Party may be composed of additional members. See Annex C.

Figure 8A2-2 Flight in Column of Route

FORMING UP A SQUADRON

ORDERING A SQUADRON ON PARADE

Reference: A0-002 A-PD-201-000/PT-000 DHH 3-2. (2001). *The Canadian Forces Manual of Drill and Ceremonial*. Ottawa, ON: The Department of National Defence.

This formation should be implemented when there is an effective parade strength of more than 45 cadets.

1. Steps to Forming Up a Squadron

Reference: A0-002 Chapter 7, paragraphs 24 to 26.

- a. Prior to forming the squadron, the F Sgts shall normally call the roll and inspect their flights. They then position their flights (sized, if so ordered) normally at the edge of the parade ground. They shall report their flights' strengths prior to the markers being called.
- b. A squadron may be formed up in one of the two following formations:
 - (1) Squadron in Line (Figure 8B2-1); and
 - (2) Squadron in Column of Route (Figure 8B2-2).
- c. The squadron is normally formed up in the centre of the allotted parade ground. Knowing the squadron's strength and frontage, the SWO selects the position to fall in the markers, by:
 - (1) dividing the squadron's frontage, including intervals, in two, and marching the appropriate number of paces to the right flank for line; and
 - (2) dividing the frontage of the squadron's leading (and largest) flight by two and marching off an equal number of paces to the right flank from where the squadron will be centred, for column or close column of flights.

Note: Where space is limited, intervals and distances between squadrons and sub-squadrons may be decreased.

2. Cadet Parade Positions

- a. The unique nature of the cadet squadron allows for the adjustment of parade positions to be filled by cadet WOs and cadet senior NCOs.
- b. The following parade positions are normally filled by cadets when conducting a formal parade:
 - (1) Parade Commander (Sqn Comd) – Cadet Parade Commander (WO1);
 - (2) Parade Deputy Commander (D Comd) – Cadet WO2;
 - (3) Parade Sergeant Major – (Sqn WO) – Cadet WO2;
 - (4) Left Guide – Cadet WO;
 - (5) Flight Commander – Cadet FSgt; and
 - (6) Flight Warrant Officer – Cadet Sgt.

THIS PAGE INTENTIONALLY LEFT BLANK

FORMING UP A SQUADRON

Item	Command	By	Action	Remarks
1.			The SWO marches to, and halts, in a position three paces to the left and facing the position to be occupied by the marker of No. 1 flight.	The flights are normally positioned at the edge of the parade ground, standing easy. The SWO shall face the future position of the front rank if the squadron is to form up in line, and the right flank if the squadron is to form up in close column of flight.
2.	MARKERS	SWO	The flight markers come to attention, and march onto the parade ground. The marker of No. 1 flight halts three paces in front of and facing the SWO. The remainder halt on the left of the No. 1 flight marker and dress to the right at shoulder dressing. Upon completion of dressing, they look to the front in succession from the right. The markers remain at attention.	Flights formed on the edge of the parade ground adopt the stand at ease position. Standard pauses are observed between drill movements completed by the markers.
3.	MARKERS – NUMBER	SWO	Markers number in succession from the right, e.g. ONE, TWO, etc.	
4.	No. 1 FLIGHT RIGHT, REMAINDER LEFT – TURN	SWO	No. 1 flight marker turns right, the remainder turn left.	The SWO specifies the number of paces to be taken by Nos. 2 and 3 flight markers after completion of the left turn.
5.	No. 1 FLIGHT STAND FAST, REMAINDER QUICK – MARCH	SWO	No. 1 flight marker stands fast, the remainder quick march the required distance and halt.	
6.	No. 1 FLIGHT STAND FAST, REMAINDER ABOUT – TURN	SWO	No. 1 flight marker stands fast, the remainder about turn and cover off the No. 1 flight marker.	The SWO, by wheeling, marches out six paces in front (right flank) of No. 1 flight marker and ensures the markers are covered off.
7.	MARKERS – STEADY	SWO	The markers stand fast.	The squadron is being formed in line.

Item	Command	By	Action	Remarks
7a.	MARKERS LEFT – TURN	SWO	The markers turn left.	This order places the markers in line. The SWO then, by wheeling, assumes a position six paces in front of and facing the future centre of the squadron.
8.	SQUADRON FALL – IN	SWO	The F Sgts, together, come to attention, and turn about, facing their respective flights.	
9.	No. 1 FLIGHT – ATTENTION	No. 1 F Sgt	The flight acts as ordered.	Nos. 2 and 3 F Sgts order their flights to attention in succession, following No. 1 flight.
10.	No. 1 FLIGHT RIGHT – TURN	No. 1 F Sgt	The flight acts as ordered.	Nos. 2 and 3 F Sgts order their flights to turn in succession, following No. 1 flight.
11.	No. 1 FLIGHT QUICK – MARCH	No. 1 F Sgt	The flight acts as ordered.	Nos. 2 and 3 F Sgts order their flights to quick march in succession, following No. 1 flight.
12.	No. 1 FLIGHT – HALT	No. 1 F Sgt	The flight halts on its marker.	Nos. 2 and 3 F Sgts order their flights to quick march in succession, following No. 1 flight.
13.	No. 1 FLIGHT ADVANCE LEFT – TURN	No. 1 F Sgt	The flight acts as ordered.	Nos. 2 and 3 WOs order their flights to advance in succession, following No. 1 flight. As the No. 3 F Sgt gives the command Left – Turn all F Sgts will turn about and face the front together.
14.	SQUADRON OPEN ORDER – MARCH	SWO	The squadron acts as ordered.	
15.	SQUADRON RIGHT – DRESS	SWO	The squadron acts as ordered.	The cadet F Sgts shall turn about and observe the standard pause. No. 1 F Sgt shall, by a series of wheels, move to the right flank as per dressing a flight. The F Sgt of Nos. 2 and 3 flights shall pace off the proper intervals

Item	Command	By	Action	Remarks
				between the flight on their right and their own flight and position their markers accordingly.
16.	SQUADRON EYES – FRONT	SWO	The squadron acts as ordered.	The F Sgts turn about. No. 1 F Sgt, by a series of wheels, adopts the proper position in front of No 1 flight.
17.	REPORT YOUR FLIGHTS	SWO	F Sgts report their flights.	F Sgts, when reporting their flights, shall call out in succession.
18.	SQUADRON STAND AT – EASE	SWO	The squadron acts as ordered.	SWO awaits the arrival of the Parade Commander (Pde Comd) and turns over control of the parade at that time.

THIS PAGE INTENTIONALLY LEFT BLANK

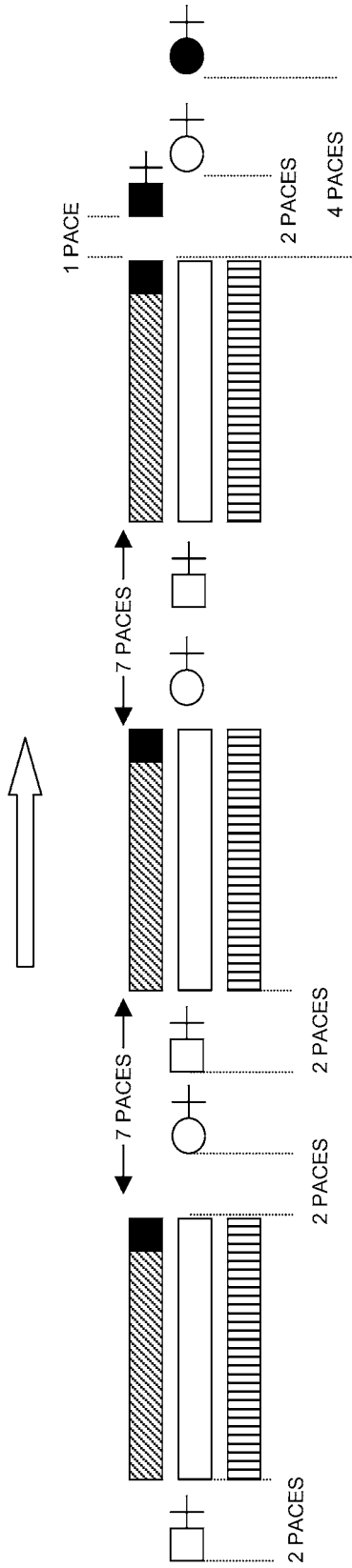

LEGEND

- +● PDE Comd
- +■ SWO
- +○ F Comd
- +□ F Sgt
- Marker
- ↑ Direction of Formation
- Flag Party
 (Flag Party Composition may vary, See Annex C)

NOTE

- A. The PDE Comd is centered two paces in front of the leading F Comd.
- B. The SWO (right guide) is one pace in front of the directing flank of the leading flight.
- C. Flights are formed as per flight formation, with the F Comds two paces in front of the centre files of their flights, and F Sgts are two paces behind their flights in line with the F Comds.

IF APPLICABLE:

- D. When WOs and senior NCOs are present, they are one pace in rear of their respective flights while the F Sgts concerned are one pace in rear of their normal positions to provide room.

Figure 8B2-2 Squadron in Column of Route

MARCHING ON AND MARCHING OFF THE FLAGS

THE CADET FLAG PARTY

Reference: A0-002 A-PD-201-000/PT-000 DHH 3-2. (2001). *The Canadian Forces Manual of Drill and Ceremonial*. Ottawa, ON: The Department of National Defence.

Composition of Cadet Squadron Flag Party

Reference: A0-002 Chapter 8, Section 2, paragraphs 1 to 2.

1. The composition of the Flag Party (one flag) may reflect one of the following:
 - a. cadet warrant officer and two cadet flight sergeants (escorts);
 - b. cadet flight sergeant and two cadet sergeants (escorts); or
 - c. cadet sergeant and two cadet corporals.



Figure 8C-1 One Flag With Escort

2. The composition of the Flag Party (two flags) may include two senior cadets and three escorts. These escorts should be of suitable drill ability and experience to bring credit to the squadron.

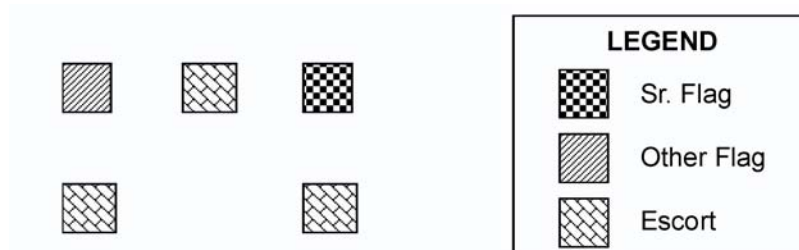

Figure 8C-2 Flag Party – Two Flags With Escort

3. The following points WRT Flag Parties shall be adhered to:
 - a. The term “Colour Party” is not to be used. Proper terminology for the formation is “Flag Party”.
 - b. The Flag Party commander is the senior cadet carrying the senior flag.
 - c. The National Flag, when carried, occupies the position of honour on the right, and is to be considered the senior flag.

THIS PAGE INTENTIONALLY LEFT BLANK

MARCHING ON AND MARCHING OFF THE FLAG(S)

MARCHING ON THE FLAG(S)

Item	Command	By	Action	Remarks
1.	FLAG PARTY ATTEN – TION	Flag Party Comd	Flag Party shall act as ordered.	Cautionary command. The flag(s) shall be held at the carry while being marched on and off the parade.
2.	FLAG PARTY – CARRY FLAGS	Flag Party Comd	Flag Party shall act as ordered.	When arms are carried on parade and the parade is given the command SLOPE – ARMS, the flag bearer(s) shall carry the flag(s) in time with the rifle movements.
3.	MARCH ON THE FLAG(S)	Pde Comd	The Flag Party Comd shall have ordered the Flag Party to attention and to the carry position.	Formation shall be at the position of attention while flag(s) are being marched on.
4.	FLAG PARTY	Flag Party Comd		Precautionary command.
5.	TO THE FLAG – SALUTE/PRESENT – ARMS	Pde Comd	Parade appointments shall salute on the last movement of the present if cadets are under arms. Cadets under arms shall present arms.	
6.	BY THE CENTRE/ RIGHT QUICK – MARCH	Flag Party Comd	Flag Party shall march with the flags caught.	The Flag Party shall march across the front of the formation between the Pde Comd and the front rank, to the centre of the formation using a series of forms along a direct route from the flank, to its parade position.
7.	CHANGE DIRECTION LEFT/ RIGHT LEFT/ RIGHT – FORM	Flag Party Comd	The Flag Party shall act as ordered.	An inexperienced Flag Party may use a well-executed wheel.
8.	FOR – WARD	Flag Party Comd	The Flag Party shall act as ordered.	
9.	COUNTER – MARCH	Flag Party Comd	The Flag Party shall act as ordered.	The Flag Party shall march to the rear of the formation,

Item	Command	By	Action	Remarks
				counter march and move forward to its parade position.
10.	FLAG PARTY – HALT	Flag Party Comd	The Flag Party shall act as ordered.	Squadron in Line: The flag shall be positioned in the centre as follows: <i>One flag.</i> In line with the front rank and the escort in line with the front rank. <i>Two flags.</i> Flags and senior escort in line with front rank. Junior escorts in line with rear rank.
11.	FLAG PARTY TO THE FLAG – SALUTE/PRESENT ARMS	Flag Party Comd		Upon halting in its parade position and if the escorts are under arms the command is <i>present arms.</i>
12.	PARADE ATTENTION	Pde Comd		Once the Flag Party is in position and at the salute/present.

MARCHING OFF THE FLAG(S)

Item	Command	By	Action	Remarks
1.	MARCH OFF THE FLAG(S)	Pde Comd		Formation shall be at the position of attention, flag(s) at the carry.
2.	FLAG PARTY	Flag Party Comd		Cautionary command.
3.	TO THE FLAG(S) – SALUTE	Pde Comd	Formation acts as ordered.	
4.	BY THE CENTRE/ RIGHT QUICK – MARCH	Flag Party Comd	Flag Party acts as ordered.	The Flag Party shall march by a series of forms to a position to the left or right of the formation. Flag Party Comd is to wait until the Pde Comd has given the command to the salute prior to stepping off.
5.	CHANGE DIRECTION LEFT/ RIGHT LEFT/ RIGHT – FORM	Flag Party Comd	Flag Party acts as ordered.	The Flag Party, by a series of forms, shall march off the parade ground to the left or right.
6.	FOR – WARD	Flag Party Comd	Flag Party acts as ordered.	
7.	ATTEN – TION	Pde Comd	Formation acts as ordered.	Given after the Flag Party has left the parade ground.
8.	FLAG PARTY HALT	Flag Party Comd	Flag Party acts as ordered.	The Flag Party shall halt at an appropriate area. Proper compliments are paid to the flag at all times.
9.	FLAG PARTY ORDER – FLAGS	Flag Party Comd	Flag Party acts as ordered.	
10.	FLAG PARTY STAND AT – EASE	Flag Party Comd	Flag Party acts as ordered.	

THIS PAGE INTENTIONALLY LEFT BLANK

MARCHING ON AND MARCHING OFF THE FLAGS DIAGRAMS

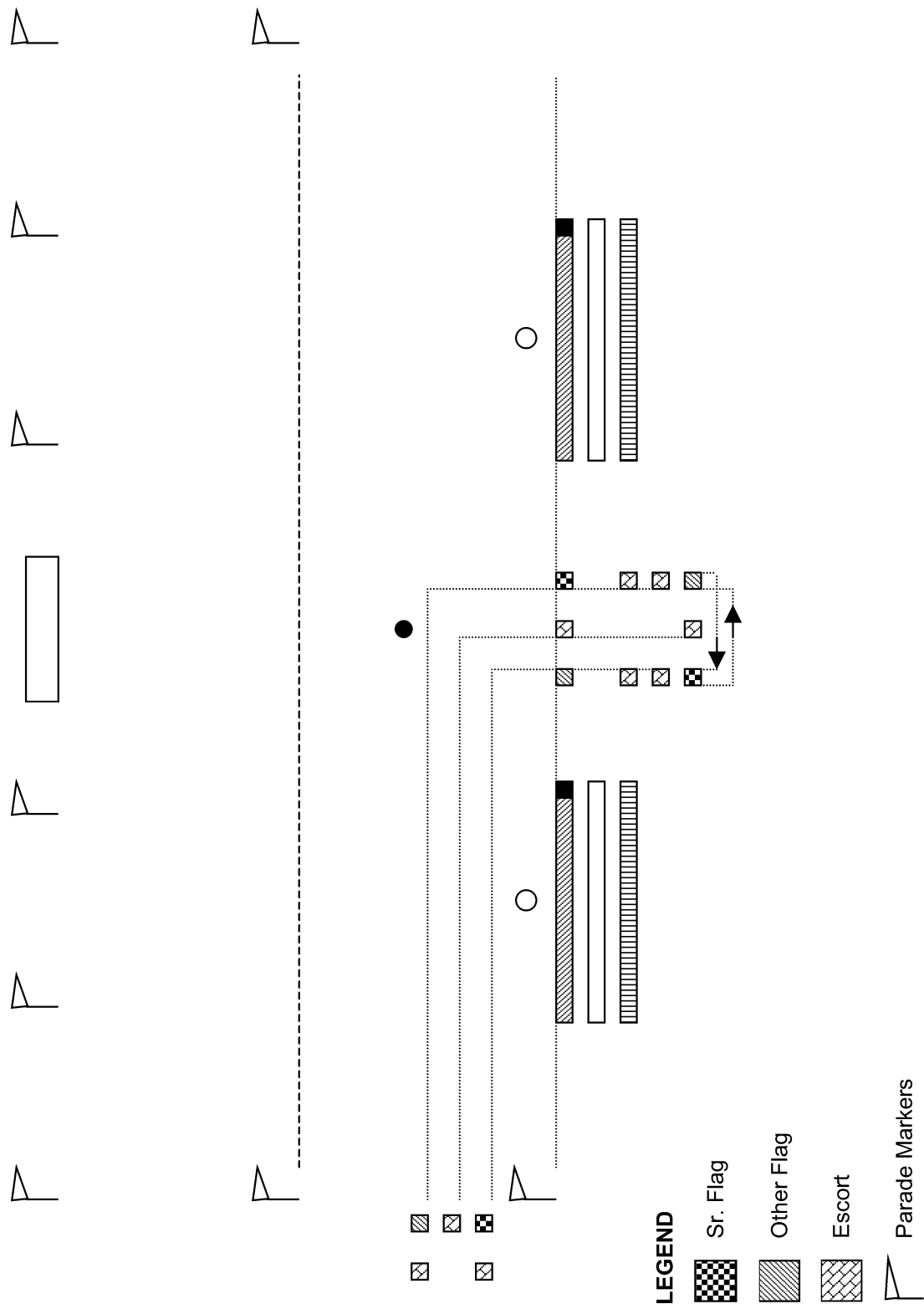

Figure 8C2-1 Marching On the Flags

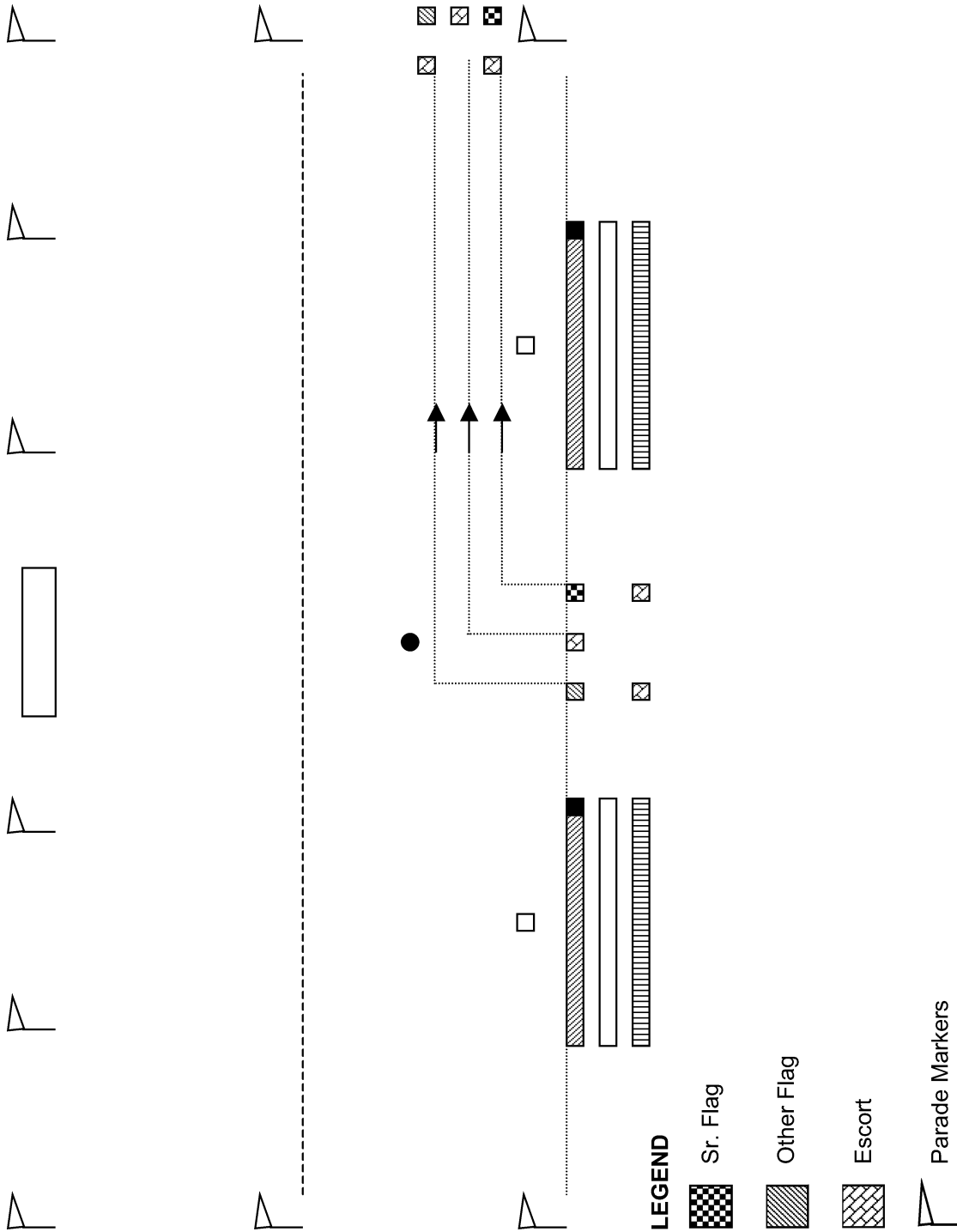

Figure 8C2-2 Marching Off the Flags

ANNUAL CEREMONIAL REVIEW PARADE SEQUENCE OF EVENTS

Reference: A0-002 A-PD-201-000/PT-000 DHH 3-2. (2001). *The Canadian Forces Manual of Drill and Ceremonial*, Chapter 9, Section 2. Ottawa, ON: The Department of National Defence.

Item	Command	By	Action	Remarks
1.			The SWO marches to, and halts, in a position three paces to the left and facing the position to be occupied by the marker of No. 1 flight.	The flights are normally positioned at the edge of the parade ground, standing easy. The SWO shall face the future position of the front rank if the squadron is to form up in line, and the right flank if the squadron is to form up in close column of flight.
2.	MARKERS	SWO	The flight markers come to attention, and march onto the parade ground. The marker of No. 1 flight halts three paces in front of and facing the SWO. The remainder halt on the left of the No. 1 flight marker and dress to the right at shoulder dressing. Upon completion of dressing, they look to the front in succession from the right. The markers remain at attention.	Flights formed on the edge of the parade ground adopt the stand at ease position. Standard pauses are observed between drill movements completed by the markers.
3.	MARKERS – NUMBER	SWO	Markers number in succession from the right, e.g. ONE, TWO, etc.	
4.	No. 1 FLIGHT RIGHT, REMAINDER LEFT – TURN	SWO	No. 1 flight marker turns right, the remainder turn left.	The SWO specifies the number of paces to be taken by Nos. 2 and 3 flight markers after completion of the left turn.
5.	No. 1 FLIGHT STAND FAST, REMAINDER QUICK – MARCH	SWO	No. 1 flight marker stands fast, the remainder quick march the required distance and halt.	
6.	No. 1 FLIGHT STAND FAST REMAINDER ABOUT – TURN	SWO	No. 1 flight marker stands fast, the remainder about turn and cover off the No. 1 flight marker.	The SWO, by wheeling, marches out six paces in front (right flank) of No. 1 flight marker and ensures the markers are covered off.

Item	Command	By	Action	Remarks
7.	MARKERS – STEADY	SWO	The markers stand fast.	The squadron is being formed in line.
7a.	MARKERS LEFT – TURN	SWO	The markers turn left.	This order places the markers in line. The SWO then, by wheeling, positions himself six paces in front of and facing the future centre of the squadron.
8.	SQUADRON FALL – IN	SWO	The F Sgts come to attention, about turn, facing their respective flight together.	
9.	No. 1 FLIGHT ATTEN – TION	No. 1 F Sgt	The flight acts as ordered.	Nos. 2 and 3 F Sgts order their flights to attention in succession, following No. 1 flight.
10.	No. 1 FLIGHT RIGHT – TURN	No. 1 F Sgt	The flight acts as ordered.	Nos. 2 and 3 F Sgts order their flights to turn in succession, following No. 1 flight.
11.	No. 1 FLIGHT QUICK – MARCH	No. 1 F Sgt	The flight acts as ordered.	Nos. 2 and 3 F Sgts order their flights to quick march in succession, following No. 1 flight.
12.	No. 1 FLIGHT HALT	No. 1 F Sgt	The flight halts on its marker.	Nos. 2 and 3 F Sgts order their flights to quick march in succession, following No. 1 flight.
13.	No. 1 FLIGHT ADVANCE LEFT – TURN	No. 1 F Sgt	The flight acts as ordered.	Nos. 2 and 3 WOs order their flights to advance in succession, following No. 1 flight. As the No. 3 F Sgt gives the command LEFT – TURN all F Sgts will turn about and face the front together.
14.	SQUADRON OPEN ORDER – MARCH	SWO	The squadron acts as ordered.	
15.	SQUADRON RIGHT – DRESS	SWO	The squadron acts as ordered.	The cadet F Sgts shall turn about and observe the standard pause. No. 1 F Sgt shall, by a series of wheels, move to the right flank as per

Item	Command	By	Action	Remarks
				dressing a flight. The F Sgt of Nos. 2 and 3 flights shall pace off the proper intervals between the flight on their right and their own flight and position their markers accordingly.
16.	SQUADRON EYES – FRONT	SWO	The squadron acts as ordered.	The F Sgts turn about. No 1 F Sgt, by a series of wheels, adopts the proper position in front of No. 1 flight.
17.	REPORT YOUR FLIGHTS	SWO	F Sgts report their flights.	F Sgts, when reporting their flights, shall call out in succession: No. 1 FLIGHT; No. 2 FLIGHT; and No. 3 FLIGHT.
18.	SQUADRON STAND AT – EASE	SWO	The squadron acts as ordered.	SWO awaits the arrival of the Parade Commander (Pde Comd) and turns over control of the parade at that time.
19.	SQUADRON ATTEN – TION	SWO	Squadron acts as ordered.	Given as the Pde Comd approaches.
20.	PARADE STAND AT – EASE	Pde Comd	Parade acts as ordered.	The formation shall hereafter be referred to as “Parade”.
21a.	PARADE ATTEN – TION	Pde Comd	Parade acts as ordered. Pde Comd turn about upon completion of the movement by the parade,	Simultaneously, the Flag Party is carrying out commands 21b. and 21c.
21b.	FLAG PARTY ATTEN – TION	Flag Party Comd	Flag Party shall act as ordered.	Cautionary command. The flag(s) shall be held at the carry while being marched on and off the parade.
21c.	FLAG PARTY – CARRY FLAGS	Flag Party Comd	Flag Party shall act as ordered.	When arms are carried on parade and the parade is given the command SLOPE – ARMS, the flag bearer(s) shall carry the flag(s) in time with the rifle movements.
22.	MARCH ON THE FLAG(S)	Pde Comd	The Flag Party Comd shall have ordered the Flag Party to attention and to the carry position.	Formation shall be at the position of attention while flag(s) are being marched on.

Item	Command	By	Action	Remarks
23.	FLAG PARTY	Flag Party Comd		Precautionary command.
24.	TO THE FLAG – SALUTE/PRESENT ARMS	Pde Comd	Parade appointments shall salute on the last movement of the present if cadets are under arms. Cadets under arms shall present arms.	
25.	BY THE CENTRE/ RIGHT QUICK – MARCH	Flag Party Comd	Flag Party shall march with the flags caught.	The Flag Party shall march across the front of the formation between the Pde Comd and the front rank, to the centre of the formation using a series of forms along a direct route from the flank, to its parade position.
26.	CHANGE DIRECTION LEFT/ RIGHT LEFT/ RIGHT – FORM	Flag Party Comd	The Flag Party shall act as ordered.	An inexperienced Flag Party may use a well-executed wheel.
27.	FOR – WARD	Flag Party Comd	The Flag Party shall act as ordered.	
28.	COUNTER – MARCH	Flag Party Comd	The Flag Party shall act as ordered.	The Flag Party shall march to the rear of the formation, counter march and move forward to its parade position.
29.	FLAG PARTY – HALT	Flag Party Comd	The Flag Party shall act as ordered.	Squadron in Line: The flag shall be positioned in the centre as follows: <i>One flag.</i> In line with the front rank and the escort in line with the front rank. <i>Two flags.</i> Flags and senior escort in line with front rank. Junior escorts in line with rear rank.
30.	FLAG PARTY TO THE FLAG – SALUTE/PRESENT ARMS	Flag Party Comd		Upon halting in its parade position and if the escorts are under arms the command is present arms.

Item	Command	By	Action	Remarks
31.	PARADE ATTEN – TION	Pde Comd		Once the Flag Party is in position and at the salute/ present.
32a.	PARADE STAND AT – EASE	Pde Comd	Formation shall act as ordered.	Awaiting the arrival of the reviewing officer.
32b.	PARADE STAND – EASY	Pde Comd	Formation shall act as ordered.	Given if the wait for the reviewing party becomes extended.
33.	PARADE ATTEN – TION	Pde Comd	Formation shall act as ordered.	Given as the reviewing officer and party approach the parade ground.
34.	GENERAL SALUTE – SALUTE	Pde Comd	Formation acts as ordered. Upon completion of the salute the Pde Comd shall report to the reviewing officer that the squadron is ready for inspection. The Pde Comd will then turn and accompany the reviewing officer on the inspection. See Figure 8D2-1 for the composition of inspection party and route. Upon the completion of the inspection the Pde Comd shall accompany the reviewing officer to the dais and request permission to carry on.	When the reviewing officer has taken up position on the dais the Pde Comd shall order the appropriate salute. If the reviewing officer is a distinguished civilian not listed in Ref: A0-002, Chapter 13, Honours, Flags and Heritage Structure of the CF, the word of command will be GENERAL SALUTE – SALUTE. An appropriate 8 bars of music may be played. If arms are not carried on parade all parade appts salute, cutting their arms to the side after a standard pause after the last note of music. If a band is not available the salute is completed with a standard pause between movements or upon the order ATTEN – TION.
35.	PARADE CLOSE ORDER – MARCH	Pde Comd	Formation shall act as ordered.	
36.	PARADE SHALL MARCH PAST IN COLUMN OF ROUTE. MOVE TO THE RIGHT IN COLUMN OF ROUTE RIGHT – TURN	Pde Comd	Formation shall act as ordered.	The size of the formation shall dictate the command sequence for the march past. Flight size formation shall act on the commands of the Pde Comd. Larger formations shall act on the command in succession by flight.

Item	Command	By	Action	Remarks
37.	FLAG PARTY AT THE HALT CHANGE DIRECTION RIGHT: RIGHT – FORM	Flag Party Comd	Flag Party shall act as ordered.	
38.	PARADE BY THE LEFT QUICK – MARCH	Pde Comd	Formation shall act as ordered.	Pde Comd to wait until the Flag Party has occupied its position. The size of the formation shall dictate the command sequence for the march past. Flight size formation shall act on the commands of the Pde Comd. Larger formations shall act on the command in succession by flight/squadron.
39.	PARADE (IN SUCCESSION OF FLIGHTS/ COMPANIES) EYES – RIGHT	Pde Comd	Formation shall act as ordered.	Given as the Pde Comd reaches marker C. In flight formations, there is no requirement for successive commands and the flight will act on the command of the Pde Comd. In a larger formation, the commands shall be given successively and the Pde Comd shall move with the word of command of the first sub- squadron.
40.	PARADE (IN SUCCESSION OF FLIGHTS/ COMPANIES) EYES – FRONT	Pde Comd	Formation shall act as ordered.	Given as the rear of the formation reaches marker D. In flight formations, there is no requirement for successive commands and the flight will act on the command of the Pde Comd. In a larger formation, the commands shall be given successively and the Pde Comd shall move with the word of command of the first sub-squadron.
41.	PARADE – HALT	Pde Comd	Formation shall act as ordered.	The formation shall be marched onto the appropriate line.

Item	Command	By	Action	Remarks
42.	PARADE WILL ADVANCE INTO LINE ADVANCE LEFT – TURN	Pde Comd	Formation shall act as ordered.	Parade positions shall turn, observe the standard pause, and then march by a series of wheels to their positions.
43.	FLAG PARTY AT THE HALT CHANGE DIRECTION LEFT LEFT – TURN	Flag Party Comd	Flag Party shall act as ordered.	
44.	PARADE OPEN ORDER – MARCH	Pde Comd	Formation shall act as ordered.	
45.	PARADE RIGHT (INWARDS) – DRESS	Pde Comd	Formation shall act as ordered.	SWO is to dress only the front rank.
46.	PARADE EYES – FRONT	Pde Comd	Formation shall act as ordered. The Pde Comd shall report to the reviewing officer and ask permission to stand the parade at ease for the presentations and awards. Upon completion of the aforementioned the Pde Comd shall request permission to carry on.	
47a.	PARADE STAND AT – EASE	Pde Comd	Formation acts as ordered.	Presentation and awards shall be issued at this time. Upon completion of the awards the formation shall be marched off the parade ground and any demonstrations and displays shall be conducted. The reviewing officer address is to take place once the formation has reformed on the parade ground (see commands 47b. to 47o.).
47b.	PARADE ATTENTION	Pde Comd	Formation shall act as ordered.	
47c.	PARADE MOVE TO THE RIGHT/ LEFT IN THREES – RIGHT/LEFT TURN	Pde Comd	Formation shall act as ordered.	

Item	Command	By	Action	Remarks
47d.	PARADE BY THE LEFT/RIGHT QUICK – MARCH	Pde Comd	Formation shall act as ordered.	The formation shall march off the parade ground to a designated position and prepare for the demonstrations and display portion of the review.
47e.	PARADE – HALT	Pde Comd	Formation shall act as ordered.	
47f.	PARADE WILL ADVANCE INTO LINE LEFT – TURN	Pde Comd	Formation shall act as ordered.	
47g.	PARADE TO YOUR DUTIES DIS – MISSED	Pde Comd	Formation shall act as ordered.	Formation shall be dismissed for the demonstration and display portion of the review.
47h.	PARADE FALL – IN	Pde Comd	Formation shall act as ordered.	Formation members shall occupy their positions as per the dismissal formation.
47i.	PARADE ATTENTION	Pde Comd	Formation shall act as ordered.	
47j.	PARADE MOVE TO THE RIGHT/LEFT IN COLUMN OF THREES RIGHT/LEFT – TURN	Pde Comd	Formation shall act as ordered.	
47k.	PARADE BY THE LEFT QUICK – MARCH	Pde Comd	Formation shall act as ordered.	Formation shall march onto the parade ground on the appropriate line for the advance.
47l.	PARADE HALT	Pde Comd	Formation shall act as ordered.	
47m.	PARADE WILL ADVANCE INTO LINE LEFT/RIGHT – TURN .	Pde Comd	Formation shall act as ordered.	
47n.	PARADE RIGHT/INWARDS – DRESS	Pde Comd	Formation shall act as ordered.	Front rank only to be dressed.
47o.	PARADE EYES FRONT	Pde Comd	Formation shall act as ordered.	As per dressing a formation.

Item	Command	By	Action	Remarks
48.	PARADE SHALL ADVANCE IN REVIEW ORDER BY THE CENTRE QUICK – MARCH	Pde Comd	Formation shall act as ordered.	The advance shall normally be 15 paces. A seven-pace advance shall be conducted if there is insufficient space for a normal advance.
49.	PARADE GENERAL SALUTE – SALUTE	Pde Comd	Formation shall act as ordered.	The Pde Comd shall wait for the reviewing officer to depart the parade ground.
50.	MARCH OFF THE FLAG(S)	Pde Comd		Formation shall be at the position of attention, flag(s) at the carry.
51.	FLAG PARTY	Flag Party Comd		Cautionary command.
52.	TO THE FLAG(S) – SALUTE	Pde Comd	Formation acts as ordered.	
53.	BY THE CENTRE/ RIGHT QUICK – MARCH	Flag Party Comd	Flag Party acts as ordered.	The Flag Party shall march by a series of forms to a position to the left or right of the formation. Flag Party Comd is to wait until the Pde Comd has given the command to the salute prior to stepping off.
54.	CHANGE DIRECTION LEFT/ RIGHT LEFT/ RIGHT – FORM	Flag Party Comd	Flag Party acts as ordered.	The Flag Party, by a series of forms, shall march off the parade ground to the left or right.
55.	FOR – WARD	Flag Party Comd	Flag Party acts as ordered.	
56.	ATTEN – TION	Pde Comd	Formation acts as ordered.	Given after the Flag Party has left the parade ground.
57.	FLAG PARTY HALT	Flag Party Comd	Flag Party acts as ordered.	The Flag Party shall halt at an appropriate area. Proper compliments are paid to the flag at all times.
58.	FLAG PARTY ORDER – FLAGS	Flag Party Comdd	Flag Party acts as ordered.	

Item	Command	By	Action	Remarks
59.	FLAG PARTY STAND AT – EASE	Flag Party Comd	Flag Party acts as ordered.	
60.	PARADE MOVE TO RIGHT/LEFT IN THREES – RIGHT/ LEFT TURN	Pde Comd	Formation shall act as ordered.	The formation shall march by the most direct route to the designated dismissal area.
61.	BY THE RIGHT/ LEFT QUICK – MARCH	Pde Comd	Formation shall act as ordered.	
62.	PARADE – HALT	Pde Comd	Formation shall act as ordered.	
63.	PARADE ADVANCE LEFT – TURN	Pde Comd	Formation shall act as ordered.	The formation, upon arrival at the dismissal area, shall carry on as per established parade procedures.
64.	PARADE DIS – MISSED	Pde Comd	Formation shall act as ordered.	

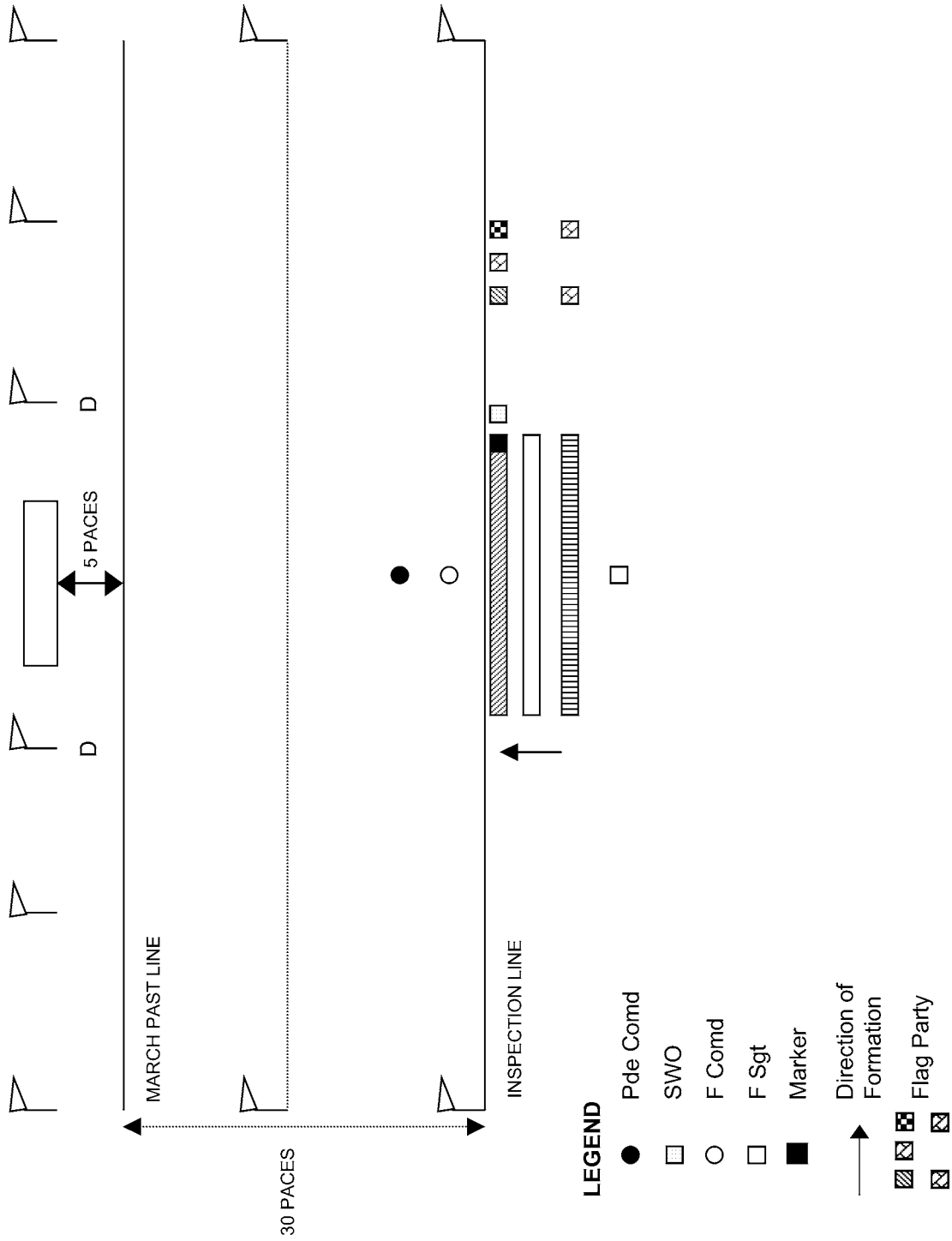

Figure 8D1-2 Flight Parade Formation With Flag Party Flight in Line

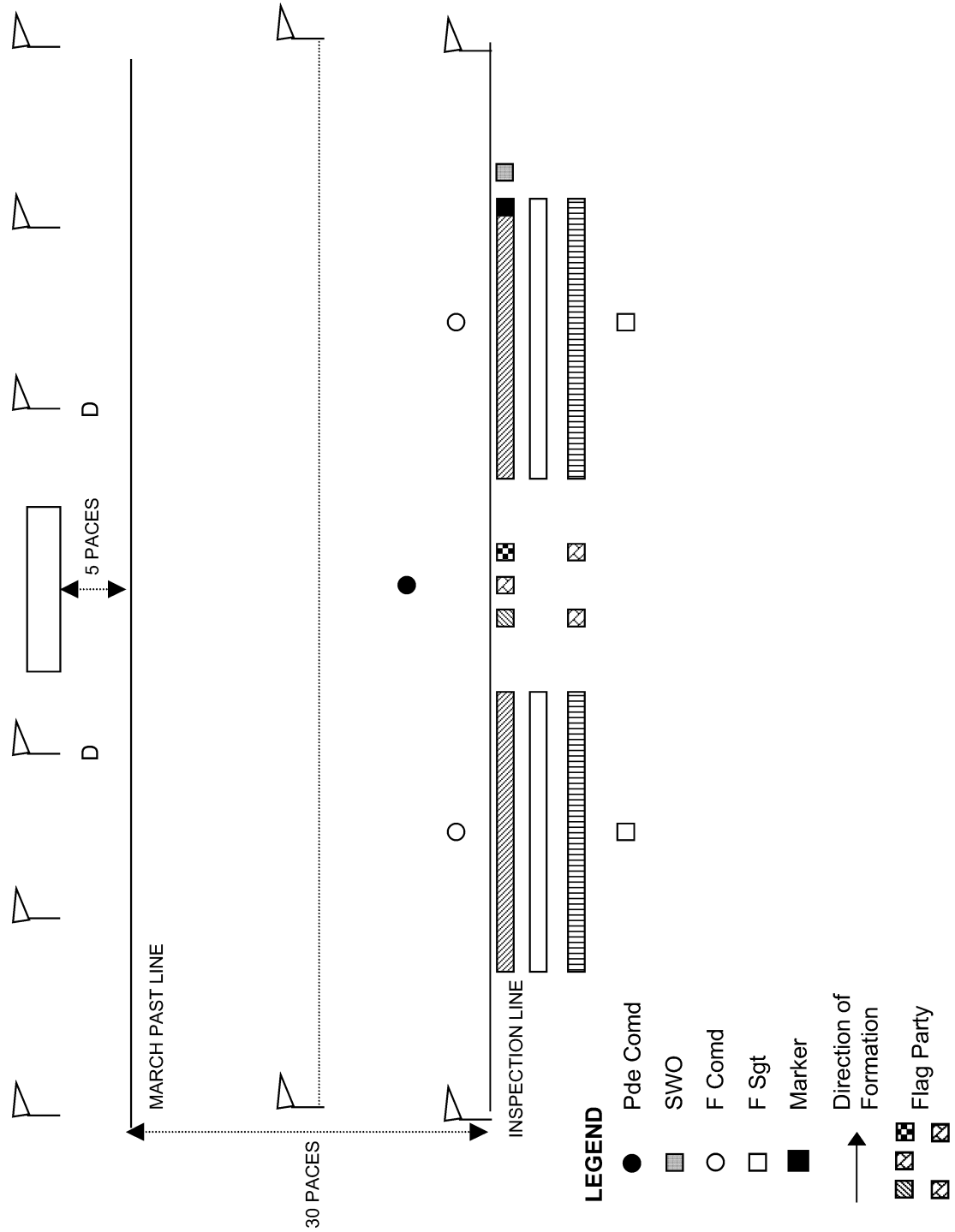

Figure 8D1-3 Squadron Parade Formation With Flag Party Squadron in Line

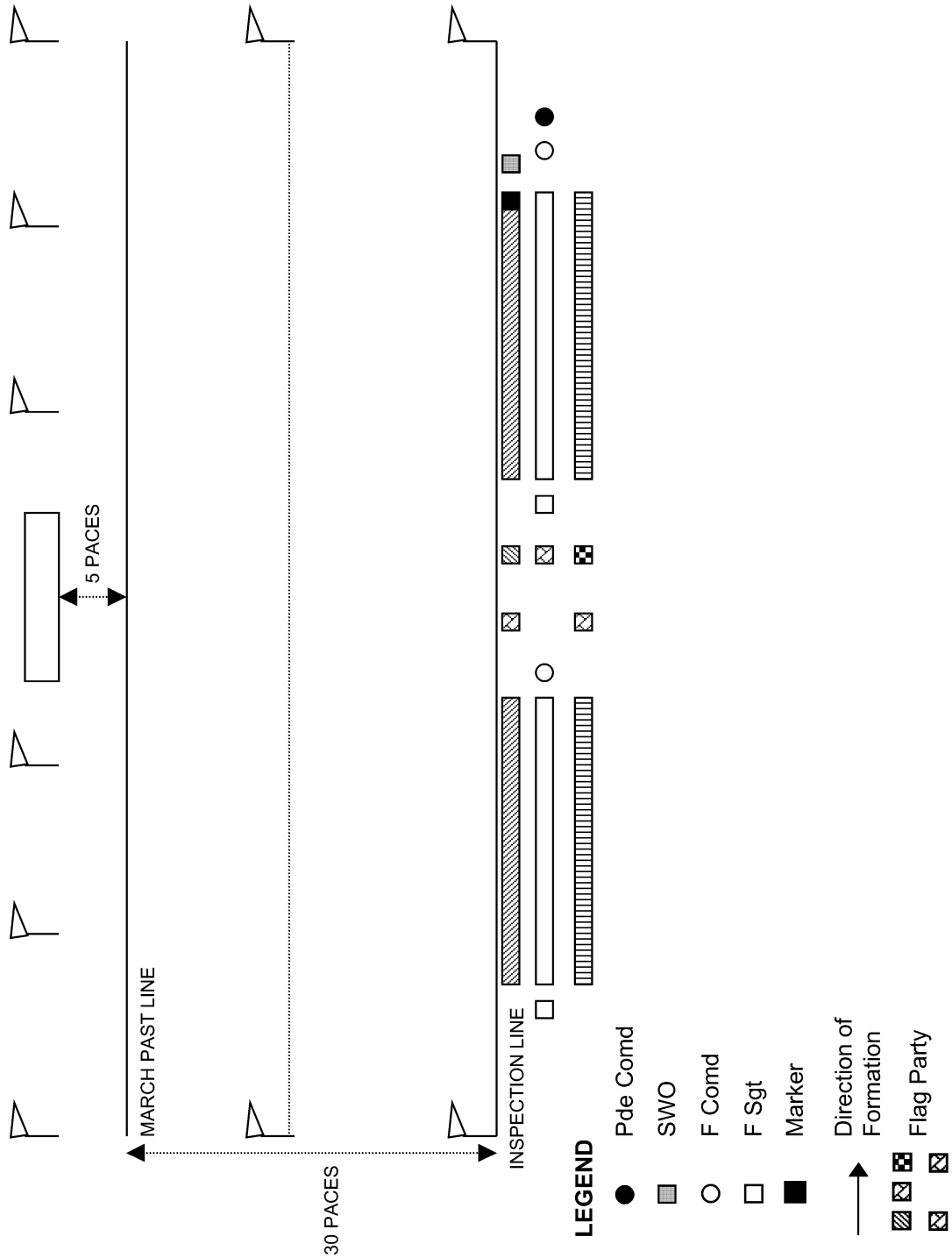

Figure 8D1-4 Squadron Parade Formation With Flag Party Squadron in Column of Route

THE INSPECTION

Inspections are carried out at the open order. As the inspecting party approaches the formation that has been ordered to stand fast, the formation commander turns right and marches to a position three paces in front of the formation marker, where the commander shall salute the officer or dignitary and report the flight.

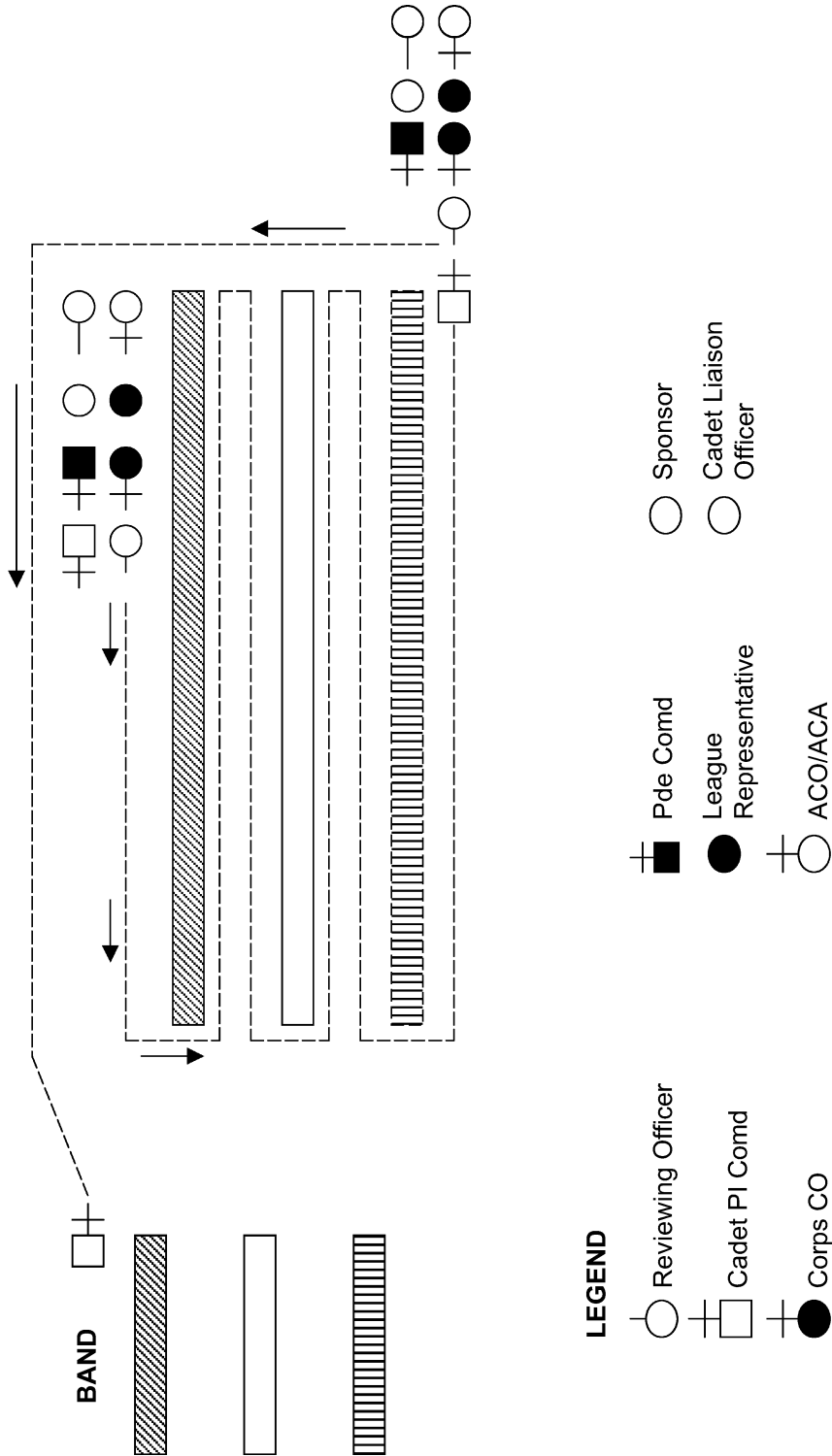

Figure 8D2-1 The Inspection

THIS PAGE INTENTIONALLY LEFT BLANK

RECEPTION OF AWARDS OR PRESENTATIONS

Reference: A0-002 A-PD-201-000/PT-000 DHH 3-2. (2001). *The Canadian Forces Manual of Drill and Ceremonial*. Ottawa, ON: The Department of National Defence.

1. Falling Out and In of Ranks

- a. The formation shall be at the open order whenever individuals will be required to fall out.
- b. The person ordered to fall out shall come to attention and, after observing the standard pause, shall march, wheeling immediately, to the right flank of the rank. The person shall then proceed in the required direction by the shortest route, being sure not to proceed in front, or within the ranks of another sub-squadron.
- c. Following reception of the award or presentation, the individual marches to the left flank of the formation and returns to his or her original position by marching in rear of the desired rank, wheeling into the original position, and halting. The individual shall pick up the dressing of the formation and either remain at attention, or stand at ease as required.

2. Reporting

- a. When reporting to an officer or dignitary, the following procedure shall be observed:
 - (1) March forward, halting two paces in front of the officer or dignitary.
 - (2) Salute, remain at attention, await acknowledgement.
 - (3) Deliver the message, receive instructions, etc. (see paragraph 1.b.).
 - (4) Salute, await acknowledgement.
 - (5) Turn right and return to original position within the ranks of the formation.
- b. When receiving a decoration, the person shall take one pace forward to receive the award, and one pace back following the presentation.

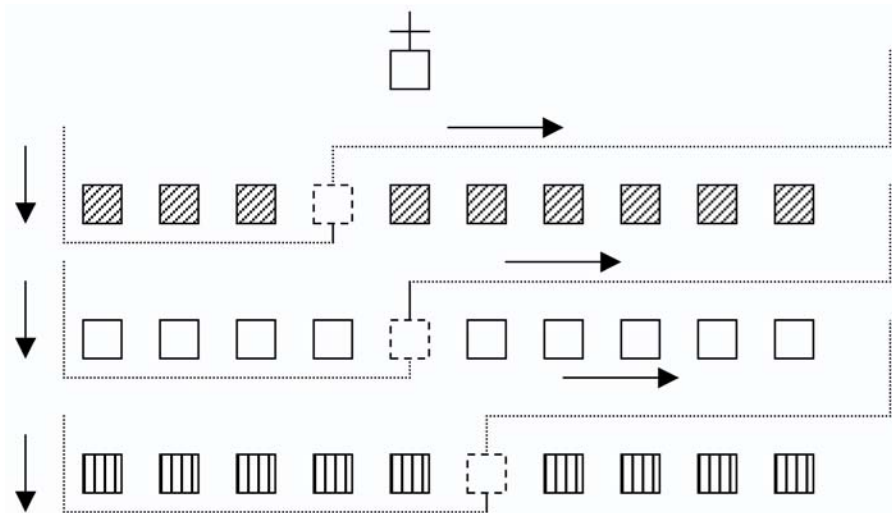

Figure 8D3-1 Falling Out/In of Formation

3. Group Presentation of Awards

- a. When reporting to an officer or dignitary for a group presentation, the following procedure shall be observed:
 - (1) Fall out in accordance with Figure 8D3-1.
 - (2) The first individual to arrive shall halt two paces in front of the officer or dignitary.
 - (3) The remainder shall halt one pace to the right of and in line with the person on the right.
 - (4) On the arrival of the last person, all shall observe the standard pause.
 - (5) All shall salute.
- b. Once all awards have been issued, all salute, turn right and march by a direct route back into their appropriate formation in accordance with Figure 8D3-1.

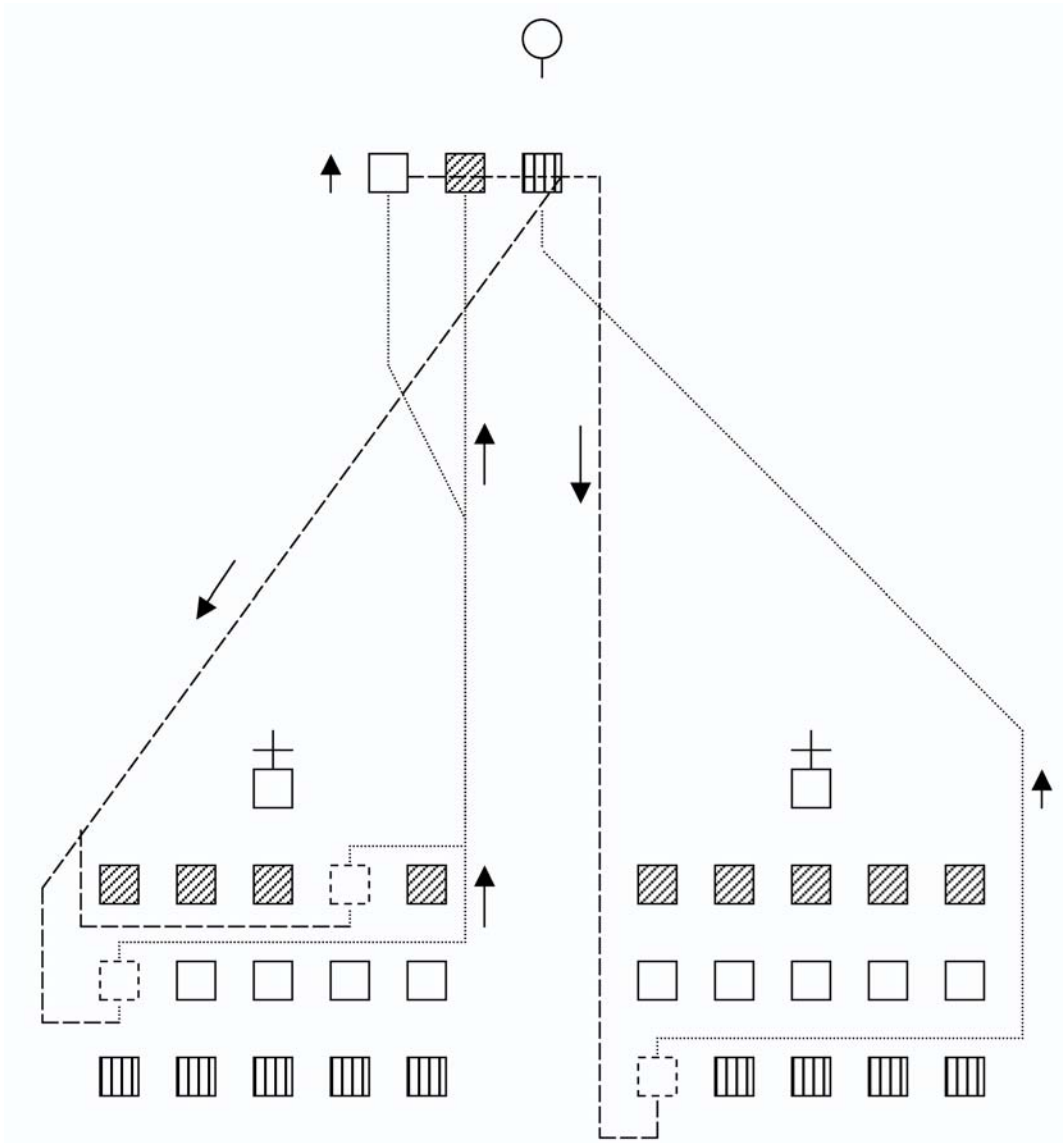

Figure 8D3-2 Reporting

GUIDELINES FOR THE CONDUCT OF A YEAR ONE DRILL COMPETITION

COMPOSITION

1. Each year one drill class will be divided into squad level teams not normally in excess of 10 persons. A team captain will be assigned by the Training Officer (Trg O) or delegate and shall be, at a minimum, a year three cadet in training. This cadet shall direct the team through the drill sequence. Each team shall be provided an opportunity to practice as a squad prior to competing. During this practice, the team captain will review all rehearsed movements from PO 108.

OFFICIALS

2. Officials shall be as follows:
 - a. Chief judge – responsible for:
 - (1) judging and marking the team captain;
 - (2) awarding penalties; and
 - (3) interpretation of rules.
 - b. Drill judge(s) – responsible for judging and marking the performance of the team during the drill sequence.

EQUIPMENT

3. Equipment required for the conduct of this competition includes:
 - a. one stopwatch;
 - b. masking tape;
 - c. tables and chairs for the judges; and
 - d. portable hand counters (clickers).

DRESS

4. Dress for the competition will be at the discretion of the squadron Trg O and IAW CATO 55-04. Uniform C-1 is encouraged, though weather conditions at the time of the competition will be the determining factor.

DRILL AREA

5. The drill area will be marked off, to include:
 - a. a restricted-access area large enough to accommodate execution of the marching and wheeling components of the competition with a judge's table placed mid-point along one of the sides of the drill area;
 - b. a clearly defined spot-mark indicating the placement of the right marker of the team;
 - c. a clearly defined spot-mark indicating the placement of the team captain, from which all words of command will be given; and
 - d. a spectator's area if required.

DRILL SEQUENCE

6. When called to compete, the team (accompanied and directed by the team captain) will be marched in two ranks to a position where they are formed in line, with the right marker at the designated point opposite the judges table, dressed at the close order. These movements will not be judged. The team captain will then approach the chief judge, report the name of the team, and request permission to carry on with the competition.

7. On receiving permission from the chief judge, the team captain will then direct the team through the drill movements in accordance with Appendix 1. The squad will be returned to its original position following the completion of the movements. The team captain will then report to the chief judge, requesting permission to dismiss. On receiving permission, the team captain will march off the team.

TIMING

8. A maximum of 15 minutes is allowed for each competing team. The timing will commence immediately following the team captain being GRANTED permission to proceed and will terminate when the team captain reports to the chief judge upon completion of the drill sequence.

DRILL AUTHORITY

9. All drill movements will be carried out IAW A-PD-201-000/PT-000, *The Canadian Forces Manual of Drill and Ceremonial*.

SCORING

10. **Drill Sequence.** One point will be deducted for each individual fault or infraction to a maximum of 80-point deductions. A maximum of five points will be deducted for a single movement (e.g. if a whole team performs a movement incorrectly, a total of five points will be deducted). The drill judge will score a maximum of 80 points, using the score sheet at Appendix 3.

11. **Team Captain.** The chief judge will evaluate the team captain, with the evaluation being based on all reporting procedures and adherence to the drill sequence listed at Appendix 1 and words of command listed at Appendix 2. Evaluation will include those characteristics listed in the score sheet and scoring guide at Appendix 4. The score will be to a maximum of 20 points and will constitute the team captain score.

12. **Final Score.** The final score will be calculated using the following method:

a. Drill	score awarded	/80
b. Team captain	score awarded	/20
c. Final score		/100

13. All scores will be summarized and tabulated on the Master Score Sheet at Appendix 5.

PENALTIES

14. Penalties are for specific infractions. Additional points will not be deducted for an infraction for which a penalty is awarded.

15. The following penalties will be awarded for infractions and will be deducted from the drill score by the chief judge:

a. Omission of a drill movement	5 points
b. Drill movement performed out of sequence	1 point

- c. Late when called to compete 2 points
- d. Exceeding maximum time allowance for sequence 2 points

INTERPRETATION OF RULES

16. In any situation where no equitable solution can be found in the rules, the chief judge will be empowered to make a ruling, which is binding to all participants.

THIS PAGE INTENTIONALLY LEFT BLANK

DRILL SEQUENCE

GENERAL

1. All movements are executed at the halt or on the march, without arms.

REFERENCES

2. All movements will be completed IAW A-PD-201-000/PT-000, *The Canadian Forces Manual of Drill and Ceremonial*, and can be found in Chapters 2 and 3 of that document.

DRILL SEQUENCE

3. The drill sequence is as follows:

At the Halt

- a. Stand Easy.
- b. Stand at Ease.
- c. Attention.
- d. Salute to the Front.
- e. Left Turn.
- f. Right Turn.
- g. Left Incline.
- h. About Turn.
- i. Right Incline.
- j. About Turn.
- k. Open Order March.
- l. Right Dress.
- m. Eyes Front.
- n. Close Order March.
- o. Right Turn.

On the March

- a. Quick March.
- b. Mark Time.
- c. Forward.
- d. Mark Time.
- e. Halt.
- f. Quick March.
- g. Left Wheel.

- h. Left Wheel.
- i. Salute to the Right on the March.
- j. Left Wheel.
- k. Right Wheel.
- l. Right Wheel.
- m. Right Wheel.
- n. Mark Time.
- o. Halt.

At the Halt

- a. Left Turn.
- b. Right Dress.
- c. Eyes Front.

WORDS OF COMMAND

GENERAL

1. All commands are to be given clearly by the team captain and without the aid of cue cards or similar memory aid.

REFERENCES

2. All words of command will be given IAW A-PD-201-000/PT-000, *The Canadian Forces Manual of Drill and Ceremonial*, and can be found in Chapters 2 and 3 of that document.

WORDS OF COMMAND

3. The following words of command will be used in sequence:

At the Halt

a. "Stand Easy"	"Squad, Stand Easy"
b. "Stand at Ease"	"Squad"
c. "Attention"	"Atten – tion"
d. "Salute to the Front"	"To the Front – Salute"
e. "Left Turn"	"Move to the left in file Left – Turn"
f. "Right Turn"	"Advance Right – Turn"
g. "Left Incline"	"Left In – cline"
h. "About Turn"	"About Turn"
i. "Right Incline"	"Retire Right In – cline"
j. "About Turn"	"Advance About – Turn"
k. "Open Order March"	"Open Order – March"
l. "Right Dress"	"Right – Dress"
m. "Eyes Front"	"Eyes – Front"
n. "Close Order March"	"Close Order – March"
o. "Right Turn"	"Move to the Right in file, Right – Turn"

On the March

a. Quick March	"Squad, By the Left, Quick – March"
b. Mark Time	"Mark – Time"
c. Forward	"For – ward"
d. Mark Time	"Mark – Time"
e. Halt	"Halt"
f. Quick March	"Squad, By the Left, Quick – March"
g. Left Wheel	"Left – Wheel"
h. Left Wheel	"Left – Wheel"
i. Salute to the Right on the March	"To the Right – Salute"
j. Left Wheel	"Left – Wheel"

- | | |
|----------------|-----------------|
| k. Right Wheel | “Right – Wheel” |
| l. Right Wheel | “Right – Wheel” |
| m. Right Wheel | “Right – Wheel” |
| n. Mark Time | “Mark – Time” |
| o. Halt | “Halt” |

At the Halt

- | | |
|----------------|-----------------------|
| a. Left Turn | “Advance Left – Turn” |
| b. Right Dress | “Right – Dress” |
| c. Eyes Front | “Eyes – Front” |

TEAM EVALUATION

TEAM: _____

Movement	Completed (✓)	Penalty
Stand Easy		
Stand at Ease		
Attention		
Salute to the Front		
Left Turn		
Right Turn		
Left Incline		
About Turn		
Right Incline		
About Turn		
Open Order March		
Right Dress		
Eyes Front		
Close Order March		
Right Turn		
Quick March		
Mark Time		
Forward		
Mark Time		
Halt		
Quick March		
Left Wheel		
Left Wheel		
Salute to the Right on the March		
Left Wheel		
Right Wheel		
Right Wheel		
Right Wheel		
Mark Time		
Halt		
Left Turn		
Right Dress		
Eyes Front		

Total Drill Infractions: _____

Total Score: _____

Comments:

Drill Judge

THIS PAGE INTENTIONALLY LEFT BLANK

TEAM CAPTAIN EVALUATION

Name: _____

Team: _____

Movement	Completed (✓)	Word of Command	Team Penalty
Stand Easy		"Squad, Stand Easy"	
Stand at Ease		"Squad"	
Attention		"Atten – tion"	
Salute to the Front		"To the Front – Salute"	
Left Turn		"Move to the left in file Left – Turn"	
Right Turn		"Advance Right – Turn"	
Left Incline		"Left In – cline"	
About Turn		"About Turn"	
Right Incline		"Retire Right In – cline"	
About Turn		"Advance About – Turn"	
Open Order March		"Open Order – March"	
Right Dress		"Right – Dress"	
Eyes Front		"Eyes – Front"	
Close Order March		"Close Order – March"	
Right Turn		"Move to the Right in File, Right – Turn"	
Quick March		"Squad, By the Left, Quick – March"	
Mark Time		"Mark – Time"	
Forward		"For – ward"	
Mark Time		"Mark – Time"	
Halt		"Halt"	
Quick March		"Squad, By the Left, Quick – March"	
Left Wheel		"Left – Wheel"	
Left Wheel		"Left – Wheel"	
Salute to the Right on the March		"To the Right – Salute"	
Left Wheel		"Left – Wheel"	
Right Wheel		"Right – Wheel"	
Right Wheel		"Right – Wheel"	
Right Wheel		"Right – Wheel"	
Mark Time		"Mark – Time"	
Halt		"Halt"	
Left Turn		"Advance Left – Turn"	
Right Dress		"Right – Dress"	
Eyes Front		"Eyes – Front"	

Comments:

a. Words of Command	1	2	3	4	5
b. Appearance	1	2	3	4	5
c. Confidence	1	2	3	4	5
d. Reporting Procedure					

TOTAL SCORE: _____ /20

Drill Judge

MASTER SCORE SHEET

Team Name	DRILL SEQUENCE						Overall Score (E + F)
	A	B	C	D	E	F	
	Drill Judge One	Drill Judge Two	Sequence Subtotal (Average: [A + B] / 2)	Team Penalties	Sequence Total (C - D)	Team Captain Total	
1.	/80	/80	/80		/80	/20	/100
2.	/80	/80	/80		/80	/20	/100
3.	/80	/80	/80		/80	/20	/100
4.	/80	/80	/80		/80	/20	/100
5.	/80	/80	/80		/80	/20	/100
6.	/80	/80	/80		/80	/20	/100
7.	/80	/80	/80		/80	/20	/100
8.	/80	/80	/80		/80	/20	/100
9.	/80	/80	/80		/80	/20	/100
10.	/80	/80	/80		/80	/20	/100

THIS PAGE INTENTIONALLY LEFT BLANK

CHAPTER 9

PO 120 – PARTICIPATE IN CANADIAN FORCES (CF) FAMILIARIZATION ACTIVITIES



ROYAL CANADIAN AIR CADETS

LEVEL ONE

INSTRUCTIONAL GUIDE



SECTION 1

EO M120.01 – DISCUSS THE ROLES OF THE CANADIAN FORCES (CF)

Total Time:

30 min

INTRODUCTION

PRE-LESSON INSTRUCTIONS

A complete list of resources needed for the instruction of this EO is located at Chapter 2 of the QSP. Specific uses for said stores are identified throughout the Instructional Guide, within the teaching point for which they are required.

Prior to instructing this lesson the instructor shall:

- review the lesson content, and become familiar with the material.
- prepare the slips of paper found in Annex A.

If available a guest speaker may deliver this lecture. The speaker should be made aware of the requirements of the period. It is the responsibility of the instructor to ensure any information not covered is provided to the cadets through a question and answer session following the presentation.

PRE-LESSON ASSIGNMENT

N/A.

APPROACH

The interactive lecture method was chosen as it allows the instructor to make a semi-formal presentation of the material where the cadets can participate by asking or responding to questions and commenting on the material. For this lesson, this method is most effective as it matches well the taxonomic level of the material and is age-appropriate by virtue of its participatory nature.

REVIEW

N/A.

OBJECTIVES

By the end of this lesson the cadet shall be expected to identify the different elements of the Canadian Forces (CF), and the roles assigned to each.

IMPORTANCE

One of the three aims of the Canadian Cadet Movement (CCM) is to stimulate interest in the CF. This EO is a basic introduction to the history and role of today's CF.

Teaching Point 1**Discuss the History of the CF**

Time: 5 min

Method: Interactive Lecture

INCEPTION (UNIFICATION 1968)

In 1964, Defence Minister Paul Hellyer tabled a white paper in Parliament, which concluded that a unified command structure – one which amalgamated the Navy, Army and Air Forces – would better serve Canadian interests. Bill C-90 was passed on 7 July and came into force on 1 August 1964.

In May 1967, Bill C-243 passed, completing the process of reorganizing the National Headquarters and commands. Bill C-243 came into force on 1 August 1968. This date marks the inception of today's CF.

DEFINING THE THREE ELEMENTS

While the concept of the CF did not evolve until 1968, Canada has a proud history of military tradition through its Army, Navy, and Air Forces.

AIR FORCE

The Canadian Air Force came into being in the spring of 1918.

The Royal Canadian Air Force received its official designation on 1 April 1924 by King George the V.

Currently the RCAF consists of thirteen wings spread out across Canada.

ARMY

With the departure of the British Military in the fall of 1871, Canada took moderate steps in producing its own forces. The country established two field artillery batteries to protect Quebec and Kingston. Thus the regular Army began its formation.

In 1883, the first Cavalry School Corps (Royal Canadian Dragoons) was established in Quebec City followed by infantry corps (Royal Canadian Regiment) in Fredericton, Saint John and Toronto.

NAVY

The Royal Canadian Navy came into being on 4 May 1910 with the passing of the Navy Bill of 1910.

Currently the Navy consists of two groups:

- MARLANT (Maritime Forces Atlantic); and
- MARPAC (Maritime Forces Pacific).

MISSION AND OBJECTIVES OF THE CF

1. Protecting Canada.
2. Defending North America in cooperation with the United States.
3. Contributing to peace and international security.

CONFIRMATION OF TEACHING POINT 1

QUESTIONS

Q1. Name one of the missions and objectives of the CF.

- Q2. How many wings does the RCAF currently have?
- Q3. In what year did the Royal Canadian Air Force originate?

ANTICIPATED ANSWERS

- A1. Protect Canada, North American defence and contributing to peace and international security.
- A2. 13.
- A3. 1 April 1924.

Teaching Point 2

Time: 10 min

Explain the Role of Each Element

Method: Interactive Lecture/Activity

The CF functions in a joint capacity for many of its international commitments; however, each element has a distinct set of responsibilities.

AIR FORCE

- Surveillance and control of Canadian airspace.
- Worldwide airlift of CF personnel and material.
- Support operations of the Army and Navy.
- Support to other government departments.
- Search and rescue.
- Humanitarian operations and emergency response including disaster relief.

ARMY

- National defence.
- Canada/US defence of North America (NORAD).
- Contribution to peacekeeping missions.
- Civil defence.
- Humanitarian operations including disaster relief.

NAVY

- Surveillance and control of Canadian waters.
- Support of Army and Air Force operations.
- Support to other government departments (fisheries, search and rescue, drug enforcement, environment).
- NATO deployments.
- Humanitarian operations including disaster relief (food and medical relief, and personal and technical aid).

ACTIVITY

Time: 5 min

OBJECTIVE

The objective of this activity is for the cadets to distinguish between the roles of the Army, Navy and Air Force.

RESOURCES

- Slips of paper found in Annex A.
- Tape.

ACTIVITY LAYOUT

- Cut out the slips of paper found in Annex A.
- Tape the slips of paper with Army, Navy and Air Force spread out on the top of the board.
- Divide the class into three groups.
- Have the slips of paper laid out on a desk at the front of the class.
- Label each group as Army, Navy or Air Force.
- Instruct each group to sift through the slips of paper and find the correct roles for their element and tape them under their heading.
- Continue until all slips have been taped under a heading.
- Confirm the activity by ensuring the slips are under the correct heading.

SAFETY

N/A.

INSTRUCTOR GUIDELINES

Supervise to ensure all cadets are participating in the activity.

Teaching Point 3

Identify CF Wing/Base Locations

Time: 10 min

Method: Interactive Lecture



The instructor can utilize a map of Canada to help identify the different base locations throughout the country. Coloured pushpins will prove beneficial.

- Army (green).
- Navy (blue).
- Air Force (yellow or white).

Note: The choice of colours for the pins is a suggestion only.

AIR FORCE BASES

- 1 Wing/CFB Kingston (Kingston, Ontario).
- 3 Wing/CFB Bagotville (Alouette, Quebec).
- 4 Wing/CFB Cold Lake (Cold Lake, Alberta).
- 5 Wing/CFB Goose Bay (Happy Valley-Goose Bay, Labrador).
- 8 Wing/CFB Trenton (Trenton, Ontario).
- 9 Wing/CFB Gander (Gander, Newfoundland).
- 12 Wing/CFB Shearwater (Shearwater, Nova Scotia).
- 14 Wing/CFB Greenwood (Greenwood, Nova Scotia).
- 15 Wing/CFB Moose Jaw (Moose Jaw, Saskatchewan).
- 16 Wing/CFB Borden (Borden, Ontario).
- 17 Wing/CFB Winnipeg (Winnipeg, Manitoba).
- 19 Wing/CFB Comox (Lazo, British Columbia).
- 22 Wing/CFB North Bay (North Bay, Ontario).

LAND FORCE BASES

- CFB Borden Training Schools (Borden, Ontario).
- CFB Gagetown (Oromocto, New Brunswick).
- CFB Petawawa (Petawawa, Ontario).
- CFB Valcartier (Valcartier, Quebec).
- CFB Shilo (Shilo, Manitoba).
- CFB Wainwright (Wainwright, Alberta).

MARITIME FORCE BASES

- CFB Halifax/Stadacona (Halifax, Nova Scotia).
- CFB Esquimalt (Victoria, British Columbia).
- CFB Greenwood (Greenwood, Nova Scotia).
- CFB Shearwater (Shearwater, Nova Scotia).

CONFIRMATION OF TEACHING POINT 3

QUESTIONS

- Q1. In what province would you find CFB Borden: Alberta or Ontario?
- Q2. Where is CFB Gagetown located?
- Q3. What base is located in Victoria, British Columbia?

ANTICIPATED ANSWERS

- A1. Ontario.
- A2. Oromocto, New Brunswick.
- A3. CFB Esquimalt.



The instructor should point out Cadet Summer Training Centres that are located at bases to highlight the way the CF assists the Cadet Program, including:

- 19 Wing/CFB Comox – Regional Gliding School and HMCS Quadra;
- CFB Esquimalt – Albert Head Air Cadet Summer Training Centre;
- 4 Wing/CFB Cold Lake – Cold Lake Air Cadet Summer Training Centre;
- CFB Borden – Blackdown Cadet Summer Training Centre;
- 8 Wing/CFB Trenton – Trenton Air Cadet Summer Training Centre;
- CFB Kingston – HMCS Ontario;
- CFSU (O) Connaught – Connaught Cadet Summer Training Centre;
- CFB Valcartier – CIEC Valcartier;
- 3 Wing/CFB Bagotville – CIEC Bagotville;
- ASU St. Jean – Regional Gliding School;
- CFB Gagetown – Argonaut Army Cadet Summer Training Centre;
- 14 Wing/CFB Greenwood – Greenwood Air Cadet Summer Training Centre; and
- 12 Wing/CFB Shearwater – Regional Sail Centre.

END OF LESSON CONFIRMATION

QUESTIONS

- Q1. In what year did unification of the CF occur?
- Q2. What are the three roles of the CF?
- Q3. Are humanitarian missions a role of the elements?

ANTICIPATED ANSWERS

- A1. 1968.
- A2. Protection of Canada, defence of North America, and peace and international security.
- A3. Yes.

CONCLUSION

HOMEWORK/READING/PRACTICE

N/A.

METHOD OF EVALUATION

There is no formal assessment of this EO.

CLOSING STATEMENT

The cadets now have general knowledge of the CF, its roles, and location of its bases. This material will allow the cadets the opportunity to interact with CF members more effectively when visiting military facilities.

INSTRUCTOR NOTES/REMARKS

N/A.

REFERENCES

- A3-017 Assistant Deputy Minister (Public Affairs). (12 September 2005). About DND/CF: *Our Mission*. Retrieved 25 May 2006, from http://www.forces.gc.ca/site/about/mission_e.asp.
- A3-018 Air Force Public Affairs. (2004). *Canada's Air Force: Mission and Roles*. Retrieved 25 May 2006, from http://www.airforce.gc.ca/today1_e.asp.
- A3-019 Department of National Defence. (2002). *About MARLANT: History, Facilities, and Role*. Retrieved 25 May 2006, from www.navy.forces.gc.ca/marlant/about/marlant_about_e.asp.
- A3-020 Department of National Defence. (2004). *Maritime Forces Pacific: MARPAC Overview*. Retrieved 25 May 2006, from www.navy.forces.gc.ca/marpac/home/marpac_home_e.asp?category=4.
- C3-040 Department of National Defence. (2004). *Canadian Military History Gateway*, Volume 3. Retrieved 25 May 2006, from http://www.cmg.gc.ca/cmh/en/page_540.asp.
- C3-041 (ISBN 0-9680685-7-X) CDIA. (2004). *The Canadian Defence Almanac*. Ottawa ON: Canadian Defence Industries Association.

THIS PAGE INTENTIONALLY LEFT BLANK



COMMON TRAINING
LEVEL ONE
INSTRUCTIONAL GUIDE



SECTION 2

EO M120.02 – DISCUSS OPPORTUNITIES IN THE CANADIAN FORCES (CF)

Total Time:

30 min

INTRODUCTION

PRE-LESSON INSTRUCTIONS

The instructor shall review the lesson content and become familiar with the material prior to instruction of the lesson.

A complete list of resources needed for the instruction of this EO is located at Chapter 2 of the QSP. Specific uses for said stores are identified throughout the Instructional Guide, within the teaching point for which they are required.

PRE-LESSON ASSIGNMENT

N/A.

APPROACH

The interactive lecture method was chosen as it allows the instructor to make a semi-formal presentation of the material where the cadets can participate by asking or responding to questions and commenting on the material. For this lesson, this method is most effective as it matches well the taxonomic level of the material and is age-appropriate by virtue of its participatory nature.

REVIEW

N/A.

OBJECTIVES

By the end of this lesson the cadet shall be expected to identify career opportunities available in the CF.

IMPORTANCE

Being introduced to the career opportunities in the CF will give the cadets the opportunity to further research areas they may be interested in. As well, it will give them the opportunity to start working towards a career they may be interested in.

Teaching Point 1**Identify Regular Force CF Careers**

Time: 5 min

Method: Interactive Lecture

REGULAR FORCE

The CF is the name of an umbrella organization that covers three elements: the Navy, the Army and the Air Force. Each partner looks after issues that come up in, or on, one of our planet's main environments – the Sea, Land and Air – and some jobs in the forces offer variety. For example, a Navy cook might be employed in an Army unit; or a clerk in the Air Force could sail on a Navy ship.

When a person joins the regular force, they are signing on for several years of service. The CF offers "Terms of Service" of different lengths. The length of service depends on the needs of each occupation and the training time required for that occupation.

NON-COMMISSIONED MEMBERS

The Non-Commissioned Member (NCM) is the backbone of the military. NCMs start out as recruits and are then trained to do specific occupations in the CF. Some are trained as technicians to keep the equipment repaired; some are operators that use specific and complicated electrical and mechanical equipment; and some are users of general equipment. There are 73 NCM occupations available in the CF.

To be eligible to enrol as a NCM, one should have at least grade 10 and be a Canadian citizen. More education is better; a high school diploma is preferred.

OFFICERS

From the first day, officers are trained to be responsible for a group of people. They oversee the sailors, soldiers or air personnel in the conduct of their activities – this could be on a base or on board a ship. There are 32 officer careers in the CF.

The educational requirements to be eligible to apply as an officer are higher than those of the NCM. To be eligible to be an officer you must be a Canadian citizen and either possess the required level of university or enrol under the Regular Officer Training Plan.



Further information can be found supporting this material on the Canadian Forces Recruiting Website or at the nearest recruiting centre.

CONFIRMATION OF TEACHING POINT 1

QUESTIONS

- Q1. How many NCM occupations are available in the CF?
- Q2. What are the education requirements to enrol as an officer in the CF?
- Q3. What grade must one complete to enroll as a NCM?

ANTICIPATED ANSWERS

- A1. 73.
- A2. Canadian citizen and the required level of university.

A3. Grade 10.

Teaching Point 2

Identify Part-time/Reserve Force CF Careers

Time: 5 min

Method: Interactive Lecture

PART TIME/RESERVE FORCE

The reserve force offers part-time employment opportunities in the Naval, Army and Air. As a reservist one would support Canada's Regular Force while earning extra income and obtaining new skills.

NAVAL RESERVE

The Naval Reserve is a major component of the Canadian Navy. It has a strength of 4000 reservists who serve as partners with the regular force to safeguard Canada's maritime security. There are currently 24 units (called Naval Reserve Divisions [NRD]) across the country.

Coastal operations, naval cooperation and guidance for shipping and mine countermeasures are three fields in which reservists specialize. Practical training is conducted at sea throughout the year, during the weekends and for extended periods, depending on individual availability.

ARMY RESERVE

The Army Reserve is the part-time component to the Canadian Army and has three roles.

- Existing reserve units are the framework or structure the Army would use to mobilize or expand the Army should the nation ever need to respond to a large crisis in a world war.
- Located in hundreds of communities across Canada, Canadians connect with their Army through the Army Reserve.
- The Army Reserve augments the professional Army by providing soldiers, units or specialists to the Canadian Forces.

AIR RESERVE

The Air Reserve is part of the reserve component of the Canadian Forces and an integral part of the total Air Force. Most Air Force wings, squadrons and units are comprised of both regular and reserve force personnel. Air Reserve flights provide administrative support to the ready pool of reserve operational and support personnel who are employed, primarily on a part-time basis, alongside their regular force counterparts.



Further information can be found supporting this material on the Canadian Forces Recruiting Website or at the nearest recruiting centre.

CONFIRMATION OF TEACHING POINT 2

QUESTIONS

- Q1. What are the reserve branches of the CF?
- Q2. When is practical training usually completed for the Naval Reserve?

ANTICIPATED ANSWERS

- A1. Naval, Army and Air Reserves.
- A2. Practical training is conducted at sea throughout the year, during the weekends and for extended periods, depending on individual availability.

Teaching Point 3

Identify Civilian CF Careers

Time: 3 min

Method: Interactive Lecture

CIVILIAN CAREERS

Civilian employees of the Department of National Defence work with the CF through their support of military operations, their contributions to the Department's corporate responsibilities and their work at bases and various regional sites.

The civilian workforce consists of a variety of careers and occupations from scientists, analysts, and managers, to operational trades such as dockyard workers, technicians and mechanics. Civilians at the Department are responsible for not only providing advice on policy issues and budget administration, but also for ensuring that our ships, tanks and armoury as well as our mission critical systems are in top condition.



Further information can be found supporting this material can be found on the Canadian Forces Recruiting Website or at the nearest recruiting centre.

CONFIRMATION OF TEACHING POINT 3

QUESTION

- Q1. What are some of the civilian careers available in the CF?

ANTICIPATED ANSWER

- A1. Scientists, analysts, managers, operational trades such as dockyard workers, technicians and mechanics.

END OF LESSON CONFIRMATION

QUESTIONS

- Q1. What are the three types of careers available in the CF?
- Q2. What are the three branches of the reserves?
- Q3. What are the two types of members in the regular force?

ANTICIPATED ANSWERS

- A1. Regular force, part-time reserve force and civilian.
- A2. Naval, Army and Air.

A3. NCMs and officers.

CONCLUSION

HOMework/READING/PRACTICE

N/A.

METHOD OF EVALUATION

There will be no formal assessment of this EO.

CLOSING STATEMENT

Being introduced to the careers available in the CF gives the cadets an opportunity to further research areas they may be interested in.

INSTRUCTOR NOTES/REMARKS

N/A.

REFERENCES

- A3-002 *DND/CF: Career Opportunities in National Defence: Part-time Careers (Reserve Force)*. (2006). Retrieved 24 May 06, from http://www.forces.gc.ca/site/careers/parttime_e.asp.
- A3-023 *Air Reserve Structure*. (2004). Retrieved 24 May 2006, from http://www.airforce.forces.ca/air_reserve/organization/organization_e.asp.
- A3-024 *One Army, Two Components*. (2005). Retrieved 24 May 2006, from http://www.armee.forces.gc.ca/lf/english/11_1.asp.
- A3-025 *What is the Naval Reserve?* (2005). Retrieved 24 May 2006, from http://www.navres.forces.ca/navres/HQ-QG/organisa/estab_e.htm.
- A3-026 *Canadian Forces Recruiting - Civilian Jobs*. (2004). Retrieved 24 May 2006, from http://www.recruiting.forces.ca/engraph/civilian/index_e.aspx.
- A3-027 *DND/CF: Career Opportunities in National Defence: Civilian Careers*. (2006). Retrieved 24 May 2006, from http://www.forces.gc.ca/site/careers/civilian_e.asp.
- A3-028 *Canadian Forces Recruiting: Employer of Choice*. (2005). Retrieved 24 May 2006, from http://www.recruiting.forces.ca/engraph/aboutus/index_e.aspx.

THIS PAGE INTENTIONALLY LEFT BLANK



ROYAL CANADIAN AIR CADETS

LEVEL ONE

INSTRUCTIONAL GUIDE



SECTION 3

EO C120.03 – CONTACT A CF MEMBER ON DEPLOYMENT

Total Time:	90 min
-------------	--------

INTRODUCTION

PRE-LESSON INSTRUCTIONS

A complete list of resources needed for the instruction of this EO is located at Chapter 4 of the QSP. Specific uses for said stores are identified throughout the Instructional Guide, within the teaching point for which they are required.

Prior to instructing this lesson the instructor shall:

- review the lesson content, and become familiar with the material; and
- consult the CF Website to obtain contact information for a suitable deployed member.

PRE-LESSON ASSIGNMENT

N/A.

APPROACH

The small group activity was selected to allow for maximum participation in the learning process. It is an interactive way to illustrate and substantiate the lesson material in a concrete manner.

The group discussion method was chosen to allow the cadets to share their knowledge, opinions, and feelings about the subject matter while still allowing the instructor to control the direction of the discussion. The instructor must ensure that points not brought forth by the class are presented. If the instructor follows the Instructional Guide, including the questions posed, this will allow the cadets to express, in their own words, what they learned from this lesson and how they may apply the information.

REVIEW

N/A.

OBJECTIVES

As a member of a team, the cadet will contact a member of the CF who is on deployment. This may be done utilizing various types of communication, such as letters or cards, emails and/or video/DVD (optional). By the end of this lesson the cadet shall be expected to contact a deployed member using one of the three communications methods listed previously.

IMPORTANCE

This will introduce the cadet to the importance of team building and communication. It will also allow them the experience of personally boosting the morale of a CF member currently on operations.

BACKGROUND KNOWLEDGE



It is the duty of the instructor to verify all **current** operations before proceeding. Assistance is available from the local cadet detachment if required.

ACTIVITY

Time: 30 min



This activity is three periods, divided over two sessions. The first session will consist of one period (1 period x 30 minutes) based on requirements. After a suitable period of time, a second session of two periods (2 periods x 30 minutes) will be conducted to review replies received, and to allow cadets to read their replies to the group.

OBJECTIVE

- Write a letter, or send a card to a deployed member; or
- Send email to a deployed member.

RESOURCES

- Writing paper.
- Envelopes.
- Pens.
- Computer.
- Any other additional pencils, pens or stationary required.

ACTIVITY LAYOUT

- The cadets shall be briefed on the activity prior to starting the letter or email. The instructor shall provide the cadets with some background on current deployment missions. Cadets will then prepare a group list of three questions they would like to ask the deployed soldier.
- Individually, cadets will prepare letters or emails. Some of the basic information required shall include the cadet's name and rank, their cadet unit, and include the three questions decided upon.
- All cadets are to be monitored to ensure that they do not provide personal information in the letters or emails. Letters will be forwarded to the instructor for review of content and then sent on to the soldier(s).
- Whether electronic or posted mail, the cadet should include the following information:
 - addressee's rank;
 - full name; and
 - unit address (if known).

- After a suitable period of time, a second session of 60 minutes will be conducted to review replies received, and to allow cadets to read their replies to the group.
- Cadets will then be led in a group discussion to debrief the activity.

SAFETY

N/A.

INSTRUCTOR GUIDELINES



At this point the instructor shall brief the cadets on any safety rules or any other guidelines pertaining the activity.

- Try to select a member who was a past cadet.
Note: If this is not possible any member may be selected.
- The instructor shall monitor the session ensuring that every cadet is participating.
- Ensure that all the necessary information is included.
- Ensure that proper grammar is utilized.
- Ensure that no personal contact information for cadets (e.g. address, phone number) is released outside the cadet organization.
- Ensure that cadets are supervised at all times when computers are being utilized.

ACTIVITY (OPTIONAL)

Time: 30 min

OBJECTIVE

Create a video or photo journal for a deployed soldier(s). **(Optional)**

RESOURCES

- Supervision (CIC Officer/CI).
- Computer.
- VHS camera.
- DVD camera.
- Tape(s)/disc(s).

ACTIVITY LAYOUT

- The procedure for this activity is basically the same as the above activity, the difference being that it should be conducted as a group activity (three to four persons).

- The cadets shall be briefed on the activity prior to beginning. The instructor shall provide the cadets with some background on current deployment missions. Cadets will then prepare a group list of three questions they would like to ask the deployed soldier.
- As a group, cadets will prepare a PowerPoint presentation or a photo journal of the unit. Basic information required shall include information on the cadets, their cadet unit, and include the three questions decided upon.
- All cadets are to be monitored to ensure that they do not provide personal information in the presentations. Finished products shall be forwarded to the instructor and then sent to the soldier(s).
- After a suitable period of time, a second session of 60 minutes will be conducted to review replies received, and to allow cadets to view their replies as a group.
- Cadets will then be led in a group discussion to debrief the activity.

SAFETY

N/A.

INSTRUCTOR GUIDELINES



At this point the instructor shall brief the cadets on any safety rules or any other guidelines pertaining the activity.

- To be completed if the unit possesses the resources to make a tape or disc.
- Ensure that this activity is performed at the corps where it is properly supervised.
- The instructor shall monitor the session ensuring that every cadet is participating.
- The PowerPoint slide show should not have any more than 15 to 20 slides.
- A video, if selected, should have duration of no more than 30 minutes.
- Ensure that no personal contact information for cadets (e.g. address, phone number) be released outside of the cadet organization.
- Unit CO to review all content prior to sending.
- Ensure that cadets are supervised at all times when computers are being utilized.

REFLECTION

Time: 15 min

Method: Group Discussion

GROUP DISCUSSION



Instructor shall ensure that all lesson objectives are drawn out towards the end of the reflection stage.

DISCUSSION QUESTIONS



TIPS FOR ANSWERING/FACILITATING DISCUSSION

- Ask questions that help facilitate discussion; in other words, avoid questions with yes or no answers.
- Prepare questions ahead of time.
- Be flexible (you are not bound to only the prepared questions).
- Encourage cadets to participate by using praise such as “great idea” or “excellent response, can anyone add to that?”.
- Try to involve everyone by directing questions to non-participants.

SUGGESTED QUESTIONS

- Q1. What did you learn about the role of the CF?
- Q2. Did anything surprise you about what the soldiers said in their replies?
- Q3. How did you feel about this activity?



Other questions and answers will develop throughout the reflection stage. The discussion should not be limited to only those suggested.

CONCLUSION

REVIEW

Upon completion of the group discussion the instructor will conclude by summarizing the discussion to ensure that all teaching points have been covered. The instructor must also take this opportunity to explain how the cadet will apply this knowledge and/or skill in the future.

MAIN TEACHING POINTS

N/A.



Instructors shall reinforce those answers and comments discussed during reflection, but must ensure that the main teaching points have been covered. Any main teaching point not brought out during the group discussion shall be inserted during review.

HOMEWORK/READING/PRACTICE

Certain parts of this lesson can be assigned as a homework assignment, but the instructor must ensure that strict rules be followed pertaining to any communications outside the unit.

METHOD OF EVALUATION

There is no formal assessment of this EO.

CLOSING STATEMENT

The cadets now have a general overview of what a deployed soldier experiences as a mission member in the performance of their duties to the country.

INSTRUCTOR NOTES/REMARKS

N/A.

REFERENCES

- A0-005 Assistant Deputy Minister (Public Affairs). (2006). *Morale By Message Board*. Retrieved 25 May 2006, from http://www.forces.gc.ca/site/community/messageboard/index_e.asp.
- A0-006 Assistant Deputy Minister (Public Affairs). (2006). *Addresses for Overseas Operations*. Retrieved 25 May 2006, from http://www.forces.gc.ca/site/community/messageboard/addresses_e.asp.

ROLES OF THE CANADIAN FORCES

National defence



Canada/US defence of North America (NORAD)



Contribution to
peacekeeping missions



Civil defence



Humanitarian operations
including disaster relief



Surveillance and control of
Canadian waters

Support of Army and Air Force operations

Support to other government departments (fisheries, search and rescue, drug enforcement, environment)

NATO deployments

Humanitarian operations including disaster relief (food and medical relief, and personal and technical aid)

Surveillance and control of Canadian airspace



Worldwide airlift of CF personnel and material



Support operations of the Army and Navy



Support to other government departments



Search and rescue



Humanitarian operations including disaster relief

Army



Navy

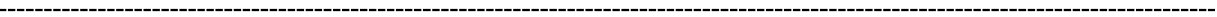

Air Force

CHAPTER 10

**PO 121 – PARTICIPATE IN CANADIAN AVIATION, AEROSPACE AND
AERODROME OPERATIONS COMMUNITY FAMILIARIZATION ACTIVITIES**



ROYAL CANADIAN AIR CADETS

LEVEL ONE

INSTRUCTIONAL GUIDE



EO M121.01 – DISCUSS AVIATION OPPORTUNITIES

Total Time: 30 min

INTRODUCTION

PRE-LESSON INSTRUCTIONS

A complete list of resources needed for the instruction of this EO is located at Chapter 2 of the QSP. Specific uses for said stores are identified throughout the Instructional Guide, within the teaching point for which they are required.

Prior to instructing this lesson the instructor shall:

- review the lesson content, and become familiar with the material;
- prepare career investigation sheets as outlined in the activity; and
- prepare career information envelopes as outlined in the activity.

PRE-LESSON ASSIGNMENT

N/A.

APPROACH

The small group activity was selected to allow for maximum participation in the learning process. It is an interactive way to illustrate and substantiate the lesson material in a concrete manner.

The group discussion method was chosen to allow the cadets to share their knowledge, opinions, and feelings about the subject matter while still allowing the instructor to control the direction of the discussion. The instructor must ensure that points not brought forth by the class are presented. If the instructor follows the Instructional Guide, including the questions posed, this will allow the cadets to express, in their own words, what they learned from this lesson and how they may apply the information.

REVIEW

N/A.

OBJECTIVES

By the end of this lesson the cadet shall be expected to have gained some basic knowledge of aviation careers, to include:

- pilots and flying instructors;
- air traffic controllers and flight service specialists;
- aircraft maintenance engineers;
- air transport ramp attendants;

- aerodrome managers; and
- aerospace engineers and aircraft assemblers.

For each career, the following shall be discussed:

- job description;
- employers;
- related Performance Objectives (POs); and
- related summer training courses.

IMPORTANCE

There are many career opportunities available in the aviation industry. Identifying possible opportunities in the aviation community can stimulate interests in the different aspects of the Cadet Program. Highlighting the link between cadet training and different career paths can increase the relevancy of cadet training. Knowledge of aviation opportunities can stimulate an interest in different aspects of the civilian and military aviation communities.

BACKGROUND KNOWLEDGE

PILOTS AND FLIGHT INSTRUCTORS

Pilots fly airplanes and helicopters to provide air transportation, training, and surveying services. Flying instructors teach flying techniques and procedures to student and licensed pilots.

Pilots and flight instructors are employed by airlines, airfreight companies, flying schools, the Canadian Forces (CF), and other public and private sector aircraft operators.

Topics such as aerodrome operations, aircraft maintenance, radio, theory of flight, navigation and meteorology will assist cadets in preparing for pilot training.

Cadet summer training courses include a three-week introduction to an aviation course, a three-week advanced aviation course and gliding and power flying scholarship courses.

AIR TRAFFIC CONTROLLERS AND FLIGHT SERVICE SPECIALISTS

Air traffic controllers use radio communication to direct air traffic within assigned airspace. Also, they control aircraft and vehicle movement at airports. Flight service specialists provide pilots with flight information essential to aviation safety, such as weather conditions.

Air traffic controllers and flight service specialists are employed by NAV Canada and the CF.

Topics such as radio communication, aerodrome operations and air traffic control will assist cadets in preparing for air traffic control training.

Cadet summer training courses include a three-week introduction to an aviation technology course and a six-week advanced aviation technology course – airport operations.

AIRCRAFT MAINTENANCE ENGINEERS (AME)

Aircraft maintenance engineers maintain, repair, overhaul, modify and test aircraft structures and systems. The aircraft systems they work on include mechanical, hydraulic, instrument, electrical and avionics.

Aircraft manufacturing, maintenance, repair companies, airlines, the CF and other aircraft operators employ AMEs.

Topics such as aircraft maintenance will assist cadets in preparing for AME training.

Cadet summer training courses include a three-week introduction to an aviation technology course and a six-week advanced aviation technology course – aircraft maintenance.

AIR TRANSPORT RAMP ATTENDANTS

Air transport ramp attendants operate ramp-servicing vehicles and equipment, handle cargo and baggage, and perform other ground support duties.

They are employed by airlines, air services companies and the federal government.

Topics such as aerodrome operations and radio will assist cadets in preparing for groundside careers.

Cadets summer training courses include a three-week introduction to an aviation technology course and a six-week advanced aviation technology course - aerodrome operations.

AERODROME MANAGERS

Aerodrome managers plan, organize, direct, control and evaluate the operations of an aerodrome. Some areas of responsibility may include marketing, budgeting, human resources, and managing the buildings and the land.

Aerodrome managers work for airport authorities, local governments or private airports.

Topics such as aerodrome operations and leadership will assist cadets in preparing for aerodrome management careers.

Cadets summer training courses include a three-week introduction to an aviation technology course and a six-week advanced aviation technology course - aerodrome operations.

AEROSPACE ENGINEERS AND AIRCRAFT ASSEMBLERS

Aerospace engineers research, design, and develop aerospace vehicles, aerospace systems and their components. They also perform duties related to testing, evaluation, installation, operation and maintenance of the same.

Aircraft and spacecraft manufacturers, air transport carriers and research institutions employ aerospace engineers.

Aircraft assemblers assemble, fit and install prefabricated parts to manufacture fixed wing aircraft, rotary wing aircraft or aircraft components.

Aircraft subassembly manufacturers employ aircraft assemblers. Subassembly companies assemble the different sections of aircraft like the landing gear.

Topics such as theory of flight, aircraft maintenance and aerospace will assist cadets in preparing for design and assembly training.

Cadet summer training courses include a three-week introduction to aviation technology course and a six-week advanced aviation technology course – aircraft maintenance.

ACTIVITY

Time: 12 min

OBJECTIVE

This activity is designed make cadets think about what is involved in different aviation careers, and how cadet training relates to these careers.

RESOURCES

- One career investigation sheet per group.
- One set of career information envelopes per group, to include:
 - job descriptions envelope;
 - employers envelope;
 - PO envelope; and
 - summer training courses envelope.

ACTIVITY LAYOUT

1. Prepare career information envelopes prior to the lesson. The information in the envelopes should be on individual pieces of paper.
2. Divide the cadets into six groups. Assign each group an aviation career from the following list:
 - pilots and flying instructors;
 - air traffic controllers and flight service specialists;
 - aircraft maintenance engineers;
 - air transport ramp attendants;
 - aerodrome managers; and
 - aerospace engineers and aircraft assemblers.



If there are less than 12 cadets in the class, divide them into three groups and assign each group two careers.

3. Give each group a career investigation sheet and set of career information envelopes. Advise each group that they will present their career to the class at the end of their investigation.
4. Have the groups open their job description envelopes. Cadets will have two minutes to:
 - read through all of the descriptions;
 - select the job description statements that match their careers; and

- record the descriptions on their career investigation sheets.
5. Have the groups open their employer envelopes. Cadets will have two minutes to:
 - read through all of the employers;
 - select the employers that someone from their career might work for. There may be many possible answers for each career;
 - record the employers on their career investigation sheets; and
 - make a sensible case for the employers they have selected.
 6. Have the groups open their PO envelopes. Cadets will have one minute to:
 - read through all of the POs;
 - select the POs that will help them prepare for their career; and
 - record these POs on their career investigation sheets.
 7. Have the groups open their summer courses envelopes. Cadets will have one minute to:
 - read through all of the summer training courses;
 - select the summer courses that will help them prepare for their career; and
 - record these summer courses on their career investigation sheets.

SAFETY

N/A.

INSTRUCTOR GUIDELINES

- Circulate among the groups to supervise and assist as necessary.
- Answer questions the cadets have about the activity and the content.
- Ensure all cadets are participating in the small group discussions to select the material.
- Keep track of and announce timings for the whole group.
- Ensure cadets are moving to the next envelope when the timings are called.
- Correct errors that groups may make during the activity.
- Offer encouragement and confirm success as groups progress through their investigations.

REFLECTION

Time: 13 min

GROUP PRESENTATIONS

Randomly select groups to present their careers. The instructor will confirm their information and make any additions or comments as necessary. Each group should have one to two minutes to present.

DISCUSSION QUESTIONS



TIPS FOR ANSWERING/FACILITATING DISCUSSION

- Ask questions that help facilitate discussion; in other words, avoid questions with yes or no answers.
- Prepare questions ahead of time.
- Be flexible (you are not bound to only the prepared questions).
- Encourage cadets to participate by using praise such as “great idea” or “excellent response, can anyone add to that?”
- Try to involve everyone by directing questions to non-participants.

SUGGESTED QUESTIONS

- Q1. What career are you most interested in, and why?
- Q2. Does anyone know someone that works in one of these careers? What can you tell us about their job?
- Q3. How will Air Cadet training assist in preparing for these careers?

CONCLUSION

HOMEWORK/READING/PRACTICE

N/A.

METHOD OF EVALUATION

There is no formal assessment of this lesson.

CLOSING STATEMENT

As cadets are exposed to more aviation-related information, they should think about the range of careers that are available to them. Every person involved in aviation has an important role to play, and all of them are critical for the safe and efficient operation of aircraft. Cadets may encounter people that work in these careers during tours. Further aviation-related classes can be associated with many of the careers discussed.

INSTRUCTOR NOTES/REMARKS

N/A.

REFERENCES

- A3-002 CATO 54-10, Cadets Canada. (1995). CATO 54-10, *Local Headquarters Training: Air cadets*. In Cadet Administrative and Training Orders (Vol. 5, 4 pages). Ottawa, ON.
- A3-003 CATO 54-20, Cadets Canada. (2000). CATO 54-20, *Summer Training Directive: Royal Canadian Air Cadets*. In Cadet Administrative and Training Orders (Vol. 5, 4 pages). Ottawa, ON.
- C3-001 *National Occupation Classification 2001 (NOC2001)*. (2001). Retrieved 23 March 2006, from <http://www.hrhc.gc.ca/2001/e/generic/welcome.shtml>.

CAREER INVESTIGATION SHEET

TEAM MEMBERS: _____

CAREER: _____

JOB DESCRIPTION: _____

EMPLOYERS: _____

RELATED POs _____

RELATED SUMMER TRAINING _____

THIS PAGE INTENTIONALLY LEFT BLANK

CAREER INFORMATION ENVELOPES

Job Descriptions	
Fly airplanes and helicopters to provide air transportation, training, and surveying services.	Teach flying techniques and procedures to students and licensed pilots.
Direct air traffic within assigned airspace, and control moving aircraft and service vehicles at airports.	Provide pilots with flight information essential to aviation safety.
Maintain, repair, and test aircraft structures and systems.	Drive ramp equipment, handle cargo and baggage, and do other ground support jobs at airports.
Manage the operations of an aerodrome, including the people, the money, the buildings, and the land.	Design aerospace vehicles and systems.
Put together and install pre-made parts to make airplanes and helicopters.	

Employers				
Airlines	Air cargo companies	Canadian Forces	Private companies	Flying schools
NavCanada – runs all the air traffic control services in Canada	Aircraft manufacturing companies	Aircraft maintenance companies	Ground support companies	Airport management authorities
Local governments	Private airports	Aircraft and spacecraft manufacturers	Research institutions	Aircraft part manufacturers

POs				
Theory of flight	Navigation	Meteorology	Radio	Aerodrome operations
Aircraft maintenance	Air traffic control	Leadership	Aerospace	

Summer Courses				
Introduction to Aviation	Gliding Scholarship	Power Scholarship	Air Traffic Control Scholarship	Aircraft Maintenance Scholarship
Aerodrome Operations Scholarship	Introduction to Leadership	Introduction to Aerospace	Aerospace Scholarship	

THIS PAGE INTENTIONALLY LEFT BLANK

CHAPTER 11

PO 129 – COMMUNICATE USING THE PHONETIC ALPHABET AND NUMBERS



ROYAL CANADIAN AIR CADETS

LEVEL ONE

INSTRUCTIONAL GUIDE



EO M129.01 – RECITE THE PHONETIC ALPHABET

Total Time:

30 min

INTRODUCTION

PRE-LESSON INSTRUCTIONS

A complete list of resources needed for the instruction of this EO is located at Chapter 2 of the QSP. Specific uses for said stores are identified throughout the Instructional Guide, within the teaching points for which they are required.

Prior to instructing this lesson the instructor shall:

- review the lesson content, and become familiar with the material;
- prepare a suitable classroom area; and
- gather whiteboard markers.

PRE-LESSON ASSIGNMENT

N/A.

APPROACH

The interactive lecture method was chosen as it allows the instructor to make a semi-formal presentation of the material where the cadets can participate by asking or responding to questions and commenting on the material. For this lesson, this method is most effective as it matches well the taxonomic level of the material and is age-appropriate by virtue of its participatory nature.

The group activities were selected to allow for maximum participation in the learning process. It is an interactive way to illustrate and substantiate the lesson material in a concrete manner.

REVIEW

N/A.

OBJECTIVES

By the end of this lesson the cadet shall be expected to recite the alphabet and numbers phonetically.

IMPORTANCE

It is important to know how to properly say the alphabet and numbers while communicating over a radio. This knowledge will help avoid confusion through the pronunciation of letters and numbers and the misinterpretation of messages. Cadets can use this information during flying and aircrew survival training.

Teaching Point 1**Describe the Phonetic Alphabet**

Time: 7 min

Method: Interactive Lecture

PHONETIC ALPHABET

The phonetic alphabet is used because letters that sound similar might be confused when said over a radio. An example of similar sounding letters is “**M**” and “**N**”. Therefore, each letter of the alphabet is associated with a word that is easily understood over the radio.

The phonetic alphabet is as follows:

- A – Alpha
- B – Bravo
- C – Charlie
- D – Delta
- E – Echo
- F – Foxtrot
- G – Golf
- H – Hotel
- I – India
- J – Juliet
- K – Kilo
- L – Lima
- M – Mike
- N – November
- O – Oscar
- P – Papa
- Q – Quebec
- R – Romeo
- S – Sierra
- T – Tango
- U – Uniform
- V – Victor
- W – Whiskey
- X – X-ray

- Y – Yankee
- Z – Zulu

Use of the phonetic alphabet can be heard on a familiarization flight when the pilot communicates the aircraft's call letters to the tower.

CONFIRMATION OF TEACHING POINT 1

QUESTIONS

- Q1. Why is the phonetic alphabet used?
- Q2. How is "Y" pronounced using the phonetic alphabet?
- Q3. How is "H" pronounced using the phonetic alphabet?
- Q4. How is "R" pronounced using the phonetic alphabet?

ANTICIPATED ANSWERS

- A1. To avoid confusion between letters that sound alike.
- A2. Yankee.
- A3. Hotel.
- A4. Romeo.

Teaching Point 2

Identify the Phonetic Numbers

Time: 3 min

Method: Interactive Lecture

PHONETIC NUMBERS

Phonetic numbers are used to avoid misunderstandings when using radio communication. Numbers are enunciated in the following manner:

- 0 – Zee-ro
- 1 – Wun
- 2 – Too
- 3 – Tree
- 4 – Fow-er
- 5 – Fife
- 6 – Six
- 7 – Seven
- 8 – Ait
- 9 – Nin-er

Numbers are always spoken as single digits, except for whole thousands. For example, 5280 would be spoken “fife too ait zee-ro” and 5000 would be spoken “fife tou-sand.”

Symbols are spoken out as words over the radio; e.g. the word decimal, pronounced “day-see-mal”, is used where there is a number with a decimal point.

Air traffic controllers use phonetic numbers to communicate to pilots what runway to use when taking off and landing.

CONFIRMATION OF TEACHING POINT 2

QUESTIONS

- Q1. How is the number one pronounced?
- Q2. How is the number four pronounced?
- Q3. How is 1289 pronounced?
- Q4. How is 629.03 pronounced?

ANTICIPATED ANSWERS

- A1. Wun.
- A2. Fow-er.
- A3. Wun too ait nin-er.
- A4. Six too nin-er day-see-mal zee-ro tree.

Teaching Point 3

Conduct Activities Involving the Phonetic Alphabet and Numbers

Time: 12 min

Method: Activity

ACTIVITY 1

Time: 5 min

OBJECTIVE

The objective of this activity is for cadets to spell out their name using the phonetic alphabet.

RESOURCES

- Whiteboard.
- Whiteboard markers.

ACTIVITY LAYOUT

- Split the class into two teams.
- Alternating teams, have each member spell their first and last name using the phonetic alphabet.
- Give each member a number to pronounce as well.

- For each member that spells their name correctly and provides the correct pronunciation for the number, give the team two points (one point for their name and one point for the number).
- The team with the most points wins the game.

SAFETY

N/A.

INSTRUCTOR GUIDELINES

While the activity is taking place the instructor will supervise, correct the cadets and record the points on the whiteboard.

ACTIVITY 2

Time: 7 min

OBJECTIVE

The objective of this activity is to solve hangman words and phrases by asking for the letters and numbers phonetically.

RESOURCES

- Whiteboard.
- Whiteboard markers.

ACTIVITY LAYOUT

- Split the class into two teams.
- Choose a word or phrase and write the number of blanks on the whiteboard; incorporate numbers into the word or phrase (e.g. Mission Impossible 3).
- Draw the frame for the man to be hung on.
- Alternating teams, have each team choose a letter or number phonetically.
- If the letter or number is in the word or phrase, write it in the proper blank.
- If the letter is not in the word or phrase, draw the head on the frame and write the letter on the board so it does not get chosen again.
- Continue drawing the head, body, arms, legs and feet each time a letter is not present in the word or phrase.
- The first team to guess the word or phrase wins.
- If the man is completely drawn before the word or phrase is guessed, both teams lose.
- As time allows, proceed with more words and phrases.

SAFETY

N/A.

INSTRUCTOR GUIDELINES

While the activity is taking place, the instructor will supervise, correct the cadets, and act as a recorder for the game.

END OF LESSON CONFIRMATION

The end of lesson confirmation will involve the cadets writing a short story that should include at least five of the phonetic alphabet words. For example, "A man and a woman attended a dance class in **November** and learned how to dance the **tango**." After three min, select a few cadets to present their stories to the class.

CONCLUSION

HOMEWORK/READING/PRACTICE

Short stories can be finished as homework if there is insufficient class time. A word search is included in the interactive handbook for the cadets to complete on their own time.

METHOD OF EVALUATION

There is no formal assessment of this EO.

CLOSING STATEMENT

Knowledge of the proper way to use the alphabet and numbers is essential to ensure radio messages are transmitted and understood properly. This knowledge ensures the proper use of voice procedures during flying training and aircrew survival training.

INSTRUCTOR NOTES/REMARKS

N/A.

REFERENCES

A3-001 A-CR-CCP-263/PT001, *From the Ground Up: Millennium Edition* (2000). Ottawa, ON: Aviation Publishers.

CHAPTER 12

PO 130 – PARTICIPATE IN AVIATION ACTIVITIES



ROYAL CANADIAN AIR CADETS

LEVEL ONE

INSTRUCTIONAL GUIDE



SECTION 1

EO M130.01 – IDENTIFY AIRCRAFT AS MILITARY, CIVILIAN AND CADET

Total Time:

60 min

INTRODUCTION

PRE-LESSON INSTRUCTIONS

A complete list of resources needed for the instruction of this EO is located at Chapter 2 of the QSP. Specific uses for said stores are identified throughout the Instructional Guide, within the teaching point for which they are required.

Prior to instructing this lesson the instructor shall:

- review the lesson content, and become familiar with the material;
- review the slide presentation found in Annex A to incorporate the visuals with the delivery of the material;
- set-up equipment for visual presentation; and
- prepare matching cards as described in the activity of TP4.



The training aids for this EO can be presented in a number of ways, depending on the resources available at the squadron. This equipment may include a computer and projector for a PowerPoint presentation, an overhead projector for overheads or preparation of posters.

PRE-LESSON ASSIGNMENT

N/A.

APPROACH

The interactive lecture method was chosen as it allows the instructor to make a semi-formal presentation of the material where the cadets can participate by asking or responding to questions and commenting on the material. For this lesson, this method is most effective as it matches well the taxonomic level of the material and is age-appropriate by virtue of its participatory nature.

The small group activity was selected to allow for maximum participation in the learning process. It is an interactive way to illustrate and substantiate the lesson material in a concrete manner.

REVIEW

N/A.

OBJECTIVES

By the end of this lesson the cadet shall identify examples of military, civilian and cadet aircraft.

IMPORTANCE

Basic aircraft identification creates a base of understanding for further aviation topics. It adds value to additional aviation activities such as aerodrome tours, air shows and familiarization flying. It also fosters an interest in the military and civilian aviation communities by introducing cadets to aircraft commonly found in those communities.

Teaching Point 1

Identify Types of Canadian Military Aircraft

Time: 9 min

Method: Interactive Lecture

CANADIAN MILITARY AIRCRAFT

Military aircraft are used for a wide variety of tasks. These tasks include training, transport, maritime patrol, defence and search and rescue. Most military aircraft are painted flat grey or camouflage for low visibility. Those high visibility planes used for Search and Rescue (SAR) work are painted bright yellow and red.

CT-114 TUTOR

The CT-114 Tutor may be the most well known aircraft flown by the Canadian Forces (CF). It is the plane flown in the Snowbirds air demonstration squadron. The Tutor was used as a training aircraft from 1971 until 2000. It was designed and built in Canada. The Tutor has a single jet engine, low wings and a T-tail.



http://www.airforce.forces.gc.ca/today5_e.asp

Figure 12-1-1 CT-114 Tutor

CC-115 BUFFALO

The CC-115 Buffalo is mainly used for SAR operations. It has short take-off and landing (STOL) capability, which is ideal for rough landing strips. It is able to fly in almost any weather. The Buffalo is painted a highly visible yellow. It has two turboprop engines, high wings and a T-tail.



http://www.airforce.forces.gc.ca/today5_e.asp

Figure 12-1-2 CC-115 Buffalo

CC-130 HERCULES

The CC-130 Hercules is one of the most multi-purpose transport planes. It is used to airlift troops, equipment and cargo. It is also used in SAR operations and in air-to-air refuelling of fighters. With its rear cargo ramp, rugged landing gear, good short-field performance and high ground clearance of engines/propellers, the C-130 is designed to operate from unimproved airstrips in active military areas. The Hercules has four turboprop engines, high wings and a distinctively large tail.



http://www.airforce.forces.gc.ca/today5_e.asp

Figure 12-1-3 CC-130 Hercules

CC-150 A310 POLARIS

The CC-150 Polaris is the military version of a popular civilian commercial airliner, the Airbus A310-300. The main role of the Polaris is long-range transport of personnel and equipment. It can transport up to 194 passengers or 32 000 kg of cargo. The CC-150 is a wide-body, two engine turbojet with low wings.



http://www.airforce.forces.gc.ca/today5_e.asp

Figure 12-1-4 CC-150 Polaris

CP-140 AURORA

The CP-140 Aurora is a maritime patrol aircraft. It carries special sensing equipment aboard so it can detect and monitor boats and submarines. The prominent tail boom is the most obvious feature of this aircraft. It has four turboprop engines and low wings.



http://www.airforce.forces.gc.ca/today5_e.asp

Figure 12-1-5 CP-140 Aurora

CF-18 HORNET

The CF-18 Hornet is a high-performance twin-engine jet fighter that can perform air-to-air combat or ground-attack roles. The most visible difference of the CF version of this aircraft is a paint scheme incorporating a “spoof” canopy on the underside of the front fuselage. This “spoof” canopy is used to confuse an opponent in

the heat of a dogfight as to “which side is up”. The distinctive angled twin vertical fins on the tail most easily identify the CF-18.



http://www.airforce.forces.gc.ca/today5_e.asp

Figure 12-1-6 CF-18 Hornet

CH-146 GRIFFON

The CH-146 Griffon is Canada’s Utility Transport Tactical Helicopter (UTTH). It performs a wide variety of roles that include airlift of equipment and personnel, command and liaison flights, surveillance and reconnaissance, casualty evacuation, logistic transport, search and rescue, counter-drug operations and domestic relief operations. The Griffon has a four-blade main rotor and landing skids. It has a camouflage paint scheme.



http://www.airforce.forces.gc.ca/today5_e.asp

Figure 12-1-7 CH-146 Griffon

CH-149 CORMORANT

The CH-149 Cormorant is a SAR helicopter. It has three powerful engines that drive a five-bladed rotor. Its ice protection system allows it to operate in continuous icy conditions. It is also able to withstand high winds. These features make it ideal for Canada’s demanding geography and climate. The Cormorant has rear-ramp access and a large amount of cabin space. It can carry 12 stretchers or a load of 5000 kg. Unlike the Griffon, the Cormorant has retractable landing gear and is painted bright yellow.



http://www.airforce.forces.gc.ca/today5_e.asp

Figure 12-1-8 CH-149 Cormorant

CONFIRMATION OF TEACHING POINT 1

QUESTIONS

- Q1. What type of aircraft is this? (Show CC-130 Hercules)
- Q2. What type of aircraft is this? (Show CT-114 Tutor)

Q3. What type of aircraft is this? (Show CH-146 Griffon)

ANTICIPATED ANSWERS

- A1. Military, CC-130 Hercules.
 A2. Military, CT-114 Tutor.
 A3. Military, CH-146 Griffon.

Teaching Point 2

Identify Civilian Aircraft

Time: 8 min

Method: Interactive Lecture

CIVILIAN AIRCRAFT

Civilian aircraft are used in a wide variety of roles including recreational, training, and transportation of people and cargo. Civilian aircraft have a wide range of paint schemes and use more colors than military aircraft. These aircraft are seen at civilian aerodromes.

CESSNA 172

The Cessna 172 is commonly used for primary flight training and familiarization flying. It is a four seat aircraft that has high wings, tricycle landing gear and a single propeller.



<http://www.airliners.net/search/photo.search?id=277285>

Figure 12-1-9 Cessna 172

PIPER PA-28 CHEROKEE

Another popular recreational and training aircraft is the Piper PA-28 Cherokee. This aircraft has low wings, tricycle landing gear and a single propeller.



<http://www.airliners.net/search/photo.search?id=246912>

Figure 12-1-10 Piper PA-28

BOEING 737

The Boeing 737 is one of the world's most popular commercial jet transport aircraft. It is a short to medium range airplane. It can carry 85 to 189 passengers, depending on the model. The Boeing 737 is flown by airlines including WestJet. The Boeing 737 has a low-wing configuration and tricycle landing gear, like most commercial transport planes. It has two turbofan jet engines mounted under the wings.



<http://www.airliners.net>

Figure 12-1-11 Boeing 737

AIRBUS A320

The Airbus A320 is a very popular commercial jet transport aircraft. It can carry 100 to 220 passengers, depending on the model. The Airbus 320 also has a low-wing configuration, nose gear, and two turbofan jet engines mounted under the wings. The biggest difference between the Airbus and the Boeing 737 is the technology in the cockpit. Airbus uses computer technology to a greater extent than Boeing. Air Canada flies the Airbus A320, and several other Airbus models.



<http://www.airliners.net/search/photo.search?id=313545>

Figure 12-1-12 Airbus A320

CONFIRMATION OF TEACHING POINT 2

QUESTIONS

- Q1. What type of aircraft is this? (Show Piper PA-28)
- Q2. What type of aircraft is this? (Show Boeing 737)
- Q3. What type of aircraft is this? (Show Cessna 172)

ANTICIPATED ANSWERS

- A1. Civilian, Piper PA-28.
- A2. Civilian, Boeing 737.
- A3. Civilian, Cessna 172.

Teaching Point 3**Identify Cadet Aircraft**

Time: 5 min

Method: Interactive Lecture

CADET AIRCRAFT

Cadet aircraft are used for training and familiarization flying. They are usually painted bright yellow and blue. (The term “cadet aircraft” is intended to mean aircraft currently owned by the Cadet Program and does not include other aircraft cadets may use on Power Flying Scholarships (Cessnas, Katanas, etc.).)

SGS 233A GLIDER

The Schweizer SGS 233A is the glider used by the Air Cadet Program for training and familiarization flying. It is a sturdy, two-place glider, with high wings. It can be launched by auto-tow, winch or tow-plane.



<http://www.aircadetleague.com/manitoba/Gliding.html>

Figure 12-1-13 SGS 233A Glider

BELLANCA SCOUT

The Bellanca Scout is one of the types of tow-planes used in the Air Cadet Gliding Program. It is a two-place tandem (front and back seating, instead of side by side), high wing, tail-dragger aircraft.



<http://www.aircadetleague.com/manitoba/Gliding.html>

Figure 12-1-14 Bellanca Scout

L19 BIRD DOG

The L19 Bird Dog is another tow-plane used in the Air Cadet Gliding Program. Like the Scout, the Bird Dog is a two-place tandem, high wing, tail-dragger aircraft. However, the L19 has a rear window, and more of a bend to the fuselage than the Scout.



Figure 12-1-15 L19 Bird Dog

Teaching Point 4**Participate in an Aircraft Identification Activity**

Time: 30 min

Method: Activity

ACTIVITY**OBJECTIVE**

This activity is designed to allow the cadets to practice identifying military, civilian and cadet aircraft by participating in a memory matching game.

RESOURCES

One set of aircraft identification matching cards per group.

ACTIVITY LAYOUT

If the class has six or fewer cadets, conduct the activity as one group.

1. Divide cadets into groups of four or less.
2. Each group will get one set of aircraft identification matching cards found in Annex B. The cards should be laid out in a six by five grid, face down.
3. The first cadet will turn two cards over.
 - If it is not a match, the cards are turned back face down, and it becomes another cadet's turn.
 - If it is a match, the cadet must identify the match.
 - If the cadet is unable to identify the match, the cards are turned back over and the turn passes to the next cadet.
 - If the cadet is unable to identify the match, the cards are turned back over and the turn passes to the next cadet.
 - If the cadet identifies the match, the cadet keeps the two cards, and takes another turn.
4. The game can be repeated as time allows, mixing-up the groups.

SAFETY

N/A.

INSTRUCTOR GUIDELINES

- Circulate among the groups to supervise and assist as necessary.
- Answer questions the cadets have about the activity.
- Ensure cadets are able to correctly identify the matching pairs before removing them from the grid.
- Offer encouragement and confirm success as the groups progress through their games.

CONCLUSION

HOMEWORK/READING/PRACTICE

N/A.



Cadets can keep a log of airplanes they see, and identify them according to the categories discussed in this lesson.

METHOD OF EVALUATION

There is no formal assessment of this EO.

CLOSING STATEMENT

Aircraft identification is a fun way of getting involved in aviation. Cadets can apply this knowledge during aviation field trips, familiarization flying and any time they see aircraft.

INSTRUCTOR NOTES/REMARKS

N/A.

REFERENCES

A3-007 Canadian Forces (2006). Retrieved 25 March 2006, from http://www.airforce.forces.gc.ca/today5_e.asp.

THIS PAGE INTENTIONALLY LEFT BLANK



ROYAL CANADIAN AIR CADETS

LEVEL ONE

INSTRUCTIONAL GUIDE



SECTION 2

EO M130.02 – DESCRIBE THE MAIN COMPONENTS OF AN AIRPLANE

Total Time:

30 min

INTRODUCTION

PRE-LESSON INSTRUCTIONS

A complete list of resources needed for the instruction of this EO is located at Chapter 2 of the QSP. Specific uses for said stores are identified throughout the Instructional Guide, within the teaching point for which they are required.

Prior to instructing this lesson the instructor shall:

- review the lesson content, and become familiar with the material; and
- prepare the puzzle envelopes, as outlined in the activity guidelines.

PRE-LESSON ASSIGNMENT

N/A.

APPROACH

The interactive lecture method was chosen as it allows the instructor to make a semi-formal presentation of the material where the cadets can participate by asking or responding to questions and commenting on the material. For this lesson, this method is most effective as it matches well the taxonomic level of the material and is age-appropriate by virtue of its participatory nature.

The small group activities were selected to allow for maximum participation in the learning process. It is an interactive way to illustrate and substantiate the lesson material in a concrete manner.

REVIEW

N/A.

OBJECTIVES

By the end of this lesson the cadet shall be expected to describe the five main components of an airplane, to include:

- fuselage;
- wings;
- empennage;
- landing gear; and

- propulsion system.

IMPORTANCE

A basic understanding of the components of an airplane will provide a foundation for further aviation topics. It will create a familiarity with airplanes that will contribute to the cadets' appreciation of the familiarization of flying and aviation tour experiences.



Before starting the class, split the cadets into groups as described in the activities. This will allow for the class to be conducted within time limits.

Teaching Point 1

Define Aircraft and Airplane

Time: 2 min

Method: Interactive Lecture

DEFINITIONS

An aircraft is a device that is used or intended to be used for flight in the air. Some examples of aircraft are hot air balloons, blimps, gliders, planes, helicopters, and hang gliders. (Electronic code of federal regulations Title 14: Aeronautics and Space, Section 1.1)

An airplane is a power-driven heavier-than-air aircraft deriving its lift in flight from aerodynamic reactions (lift) on surfaces that remain fixed under given conditions of flight (wings). (*From the Ground Up: Millennium Edition*, p. 9)

CONFIRMATION OF TEACHING POINT 1

QUESTIONS

- Q1. Is a helicopter an aircraft or an airplane? Why?
- Q2. Is a floatplane an aircraft or an airplane? Why?
- Q3. Is a glider an aircraft or an airplane? Why?

ANTICIPATED ANSWERS

- A1. Aircraft – its lift producing surfaces (the rotors) do not stay fixed during flight.
- A2. Airplane – it meets the full definition criteria.
- A3. Aircraft – it is not power-driven.



The following activity should be conducted prior to TP2 as an introduction to TP2 to TP6.

ACTIVITY

Time: 2 min

OBJECTIVE

This activity is designed to familiarize the cadet with the five main components of an airplane.

RESOURCES

One envelope per four cadets containing basic airplane component puzzle pieces found in Annex C.

ACTIVITY LAYOUT

1. Divide the class into groups of four or less. Cadets will work in the same groups for all the puzzle activities.
2. Each group will be given an envelope that contains a complete set of puzzle pieces.
3. The groups will have one minute to put together the puzzle.

SAFETY

N/A.

INSTRUCTOR GUIDELINES

- To prepare this activity, the puzzle page found in Annex C should be glued to cardstock and the puzzle pieces cut out. Prepare one puzzle for each group.
- Confirm the puzzles are assembled correctly before carrying on with TP3.
- Assist cadets if they are having difficulty completing the activity in the allotted time.
- The cadets will use this basic puzzle as a reference as they assemble the component puzzles throughout the lesson.

Teaching Point 2**Describe the Fuselage**

Time: 3 min

Method: Interactive Lecture

FUSELAGE

The fuselage is the body of the aircraft, designed to accommodate the crew, passengers and cargo. The cockpit or crew flight deck is the part of the fuselage where the pilot and flight crew operate the aircraft. The fuselage is the structural body to which the wings, the tail section, landing gear and (in most small aircraft) the engine are attached.

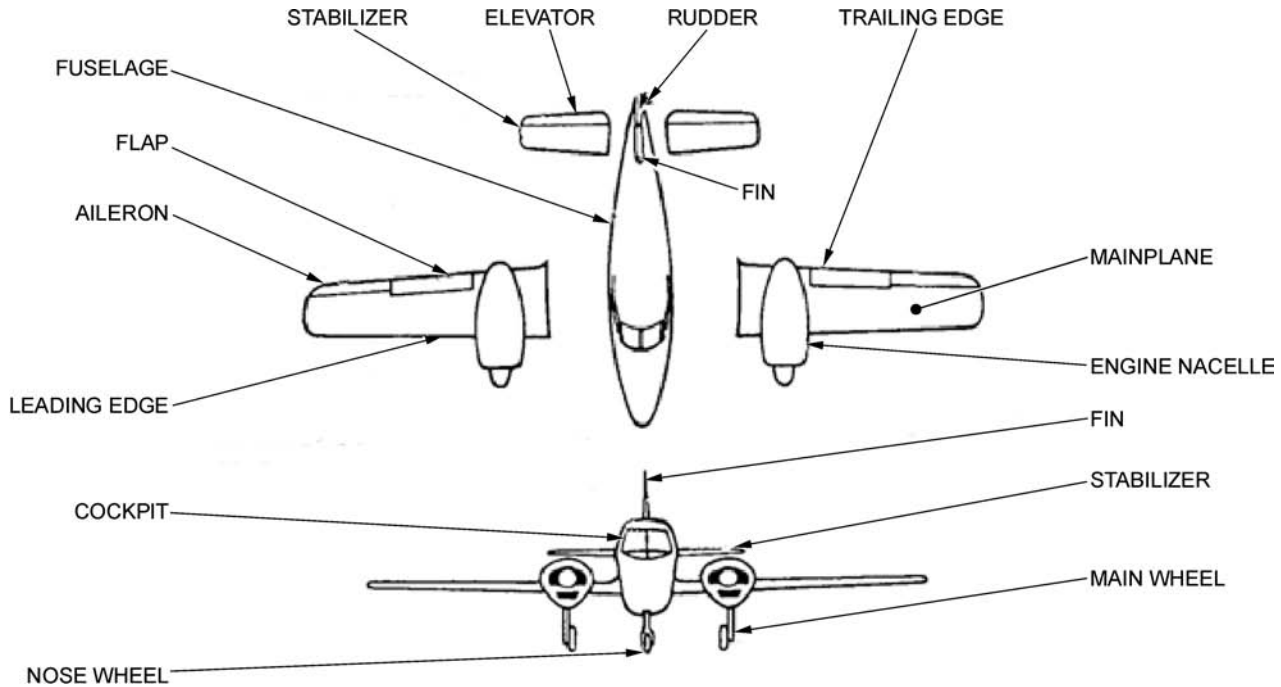

Level 1 Royal Canadian Air Cadet Handbook – A-CR-CCP-266/PT-001

Figure 12-2-1 Airplane Components

Teaching Point 3

Describe the Wings

Time: 5 min

Method: Interactive Lecture

WINGS

The fuselage is fitted with a wing on both sides. The primary purpose of the wings is to support the aircraft in flight by producing lift.

The wing root is where the wing meets the fuselage. The wing tip is the part farthest from the fuselage.

The leading edge is the front edge of the wing running from wing root to wing tip. The trailing edge is the back edge of the wing running from wing root to wing tip.

Ailerons are moveable surfaces that are hinged to the trailing edge of each wing, close to the wingtip. The ailerons control roll. Roll is the banking of the aircraft to the left and the right. The ailerons move in opposite directions to each other.

Flaps are moveable surfaces that are hinged to the trailing edge of each wing, closer to the wing root than the ailerons. They can be used during landing and take-off to provide more controlled flight at slower airspeeds. Flaps are operated with a lever or hand wheel in the cockpit.

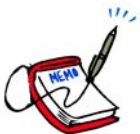

See Figure 12-2-1 to reference the location of these parts.

ACTIVITY

Time: 2 min

OBJECTIVE

This activity is designed to familiarize the cadet with the fuselage and wings.

RESOURCES

One envelope per four cadets containing fuselage and wing puzzle pieces found in Annex D.

ACTIVITY LAYOUT

1. Have cadets complete this activity in the same groups as the previous activity.
2. Give each group an envelope that contains fuselage and wing puzzle pieces.
3. The groups will have one minute to assemble these pieces.

SAFETY

N/A.

INSTRUCTOR GUIDELINES

- To prepare this activity, the puzzle pages found in Annex D should be glued to cardstock and the puzzle pieces cut out. Prepare one puzzle for each group.
- Confirm the puzzles are assembled correctly before carrying on with TP3.
- Assist cadets if they are having difficulty completing the activity in the allotted time.

Teaching Point 4

Describe the Empennage

Time: 6 min

Method: Interactive Lecture

EMPENNAGE

The empennage refers to the whole tail section of a plane. It includes the horizontal stabilizer, elevator, vertical stabilizer, and rudder.

The horizontal stabilizer is at the back of the aircraft, and helps keep the aircraft stable as it flies through the air. The horizontal stabilizer does not move.

The elevator is hinged to the horizontal stabilizer and is operated by moving the control column forward and backward. The elevator controls pitch. Pitch is the up and down movement of the aircraft's nose.

The vertical stabilizer, also called the fin, is an upright surface on the empennage. It helps keep the aircraft stable as it flies through the air. The vertical stabilizer does not move.

The rudder is hinged to the fin and is operated by the rudder pedals in the cockpit. The rudder controls yaw. Yaw is the side-to-side movement of the aircraft.

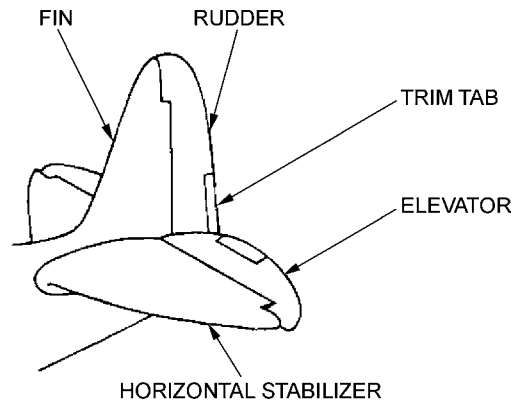

Level 1 Royal Canadian Air Cadet Handbook – A-CR-CCP-266/PT001

Figure 12-2-2 Empennage

ACTIVITY

Time: 1 min

OBJECTIVE

This activity is designed to familiarize the cadet with the empennage.

RESOURCES

One envelope per four cadets containing empennage puzzle pieces found in Annex E.

ACTIVITY LAYOUT

1. Have cadets complete this activity in the same groups as the previous activity.
2. Give each group an envelope that contains empennage puzzle pieces.
3. The groups will have one minute to assemble these pieces.

SAFETY

N/A.

INSTRUCTOR GUIDELINES

- To prepare this activity, the puzzle pages found in Annex E should be glued to cardstock and the puzzle pieces cut out. Prepare one puzzle for each group.
- Confirm the puzzles are assembled correctly before carrying on with TP3.
- Assist cadets if they are having difficulty completing the activity in the allotted time.
- This puzzle will attach to the puzzle from TP2.

Teaching Point 5**Describe the Landing Gear**

Time: 3 min

Method: Interactive Lecture

LANDING GEAR

Landing gear on an airplane is like the tires on a car. The landing gear supports the aircraft when it is on the ground and absorbs the shock of landing. All aircraft have their landing gear under the main part of the fuselage or wings. Landing gear can be fixed or retractable. Fixed gear is attached to the airplane in a permanent position. Retractable gear can fold-up into the wings or the fuselage.

There are two main landing gear configurations. Both configurations have the main wheels or main gear toward the middle of the aircraft. In a nose wheel configuration (also called tricycle) there is another wheel or gear under the nose. In a tail wheel configuration (also called conventional or tail dragger) there is another wheel or gear under the tail.

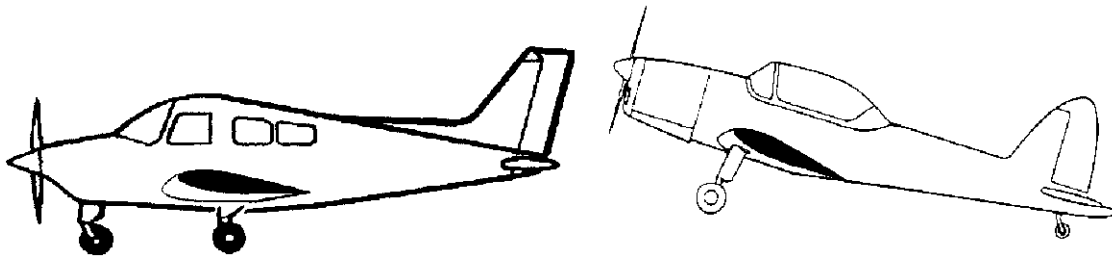

Level 1 Royal Canadian Air Cadet Handbook – A-CR-CCP-266/PT-001

Figure 12-2-3 Nose Gear vs Tail Gear

Teaching Point 6**Describe the Propulsion System**

Time: 3 min

Method: Interactive Lecture

PROPULSION SYSTEM

Power is produced by an internal combustion engine (the same as a car) with a two or three blade propeller or a gas turbine (jet) engine. A jet can be used to power a propeller – this is called a turboprop engine.

The cowling (also called the nacelle) is like the hood of a car. It encloses the engine and streamlines the airplane to reduce drag. The cowling provides cooling of the engine by ducting cool air around the engine.

ACTIVITY

Time: 1 min

OBJECTIVE

This activity is designed to familiarize the cadet with the landing gear and propulsion system.

RESOURCES

One envelope per four cadets containing landing gear and propulsion system puzzle pieces found in Annex F.

ACTIVITY LAYOUT

1. Have cadets complete this activity in the same groups as the previous activity.

2. Give each group an envelope that contains empennage puzzle pieces.
3. The groups will have one minute to assemble these pieces.

SAFETY

N/A.

INSTRUCTOR GUIDELINES

- To prepare this activity, the puzzle pages found in Annex E should be glued to cardstock and the puzzle pieces cut out. Prepare one puzzle for each group.
- Confirm the puzzles are assembled correctly before carrying on with conclusion.
- Assist cadets if they are having difficulty completing the activity in the allotted time.
- This puzzle will attach to the puzzle from TP3.

CONCLUSION

HOMEWORK/READING/PRACTICE

N/A.

METHOD OF EVALUATION

There is no formal assessment of this EO.

CLOSING STATEMENT

Being able to describe the main components of an airplane will give cadets the knowledge needed to appreciate and successfully participate in further aviation topics.

INSTRUCTOR NOTES/REMARKS

N/A.

REFERENCES

- A3-001 A-CR-CCP-263/PT-001 *From the Ground Up: Millennium Edition (28th Edition)*. (2000). Ottawa, ON: Aviation Publishers.
- C3-023 Electronic Code of Federal Regulations Title 14: *Aeronautics and Space*, Section 1.1 (2005). Retrieved 25 April 2006, from www.ecfr.gpoaccess.gov.



ROYAL CANADIAN AIR CADETS

LEVEL ONE

INSTRUCTIONAL GUIDE



SECTION 3

EO M130.03 – CONSTRUCT A MODEL AIRPLANE

Total Time:

60 min

INTRODUCTION

PRE-LESSON INSTRUCTIONS

A complete list of resourced needed for the instruction of this EO is located at Chapter 2 of the QSP. Specific uses for said stores are identified throughout the Instructional Guide, within the teaching point for which they are required.

Prior to instructing this lesson the instructor shall:

- review the lesson content, and become familiar with the material;
- prepare a completed model airplane;
- collect model material, to include:
 - pre-printed paper model template;
 - thumbtacks (one per cadet); and
 - one inch binder clips (one per cadet); and
- collect model building tools, to include:
 - scissors (one pair per cadet);
 - glue sticks (one stick per two cadets); and
 - markers (to be shared by all cadets).

PRE-LESSON ASSIGNMENT

N/A.

APPROACH

The activity was selected to allow for maximum participation in the learning process. It is an interactive way to illustrate and substantiate the material taught in EO M130.02 (Section 2).

The group discussion method was chosen to allow the cadets to share their knowledge, opinions, and feelings about the subject matter while still allowing the instructor to control the direction of the discussion. The instructor must ensure that points not brought forth by the class are presented. If the instructor follows the Instructional Guide, including the questions posed, this will allow the cadets to express, in their own words, what they learned from this lesson and how they may apply the information.

REVIEW

The pertinent review for this lesson will include:

- describe the fuselage (EO M130.02 [Section 2] TP2);
- describe the wings (EO M130.02 [Section 2] TP3);
- describe the empennage (EO M130.02 [Section 2] TP4);
- describe the landing gear (EO M130.02 [Section 2] TP5); and
- describe the propulsion system (EO M130.02 [Section 2] TP6).

OBJECTIVES

By the end of this lesson the cadet shall be expected to construct a model airplane, that will have the following components:

- fuselage (cockpit);
- wings (ailerons, flaps, leading edge, trailing edge, wing root, wing tip);
- empennage (horizontal stabilizer, vertical stabilizer, rudder, elevators);
- landing gear; and
- propulsion system (propeller, cowling).

IMPORTANCE

Cadets have learned to identify the components of an airplane. This knowledge will be useful during familiarization flights, hangar visits, and other aviation EOs. Being able to construct an airplane model provides cadets a method of confirming their knowledge of airplane components.

BACKGROUND KNOWLEDGE

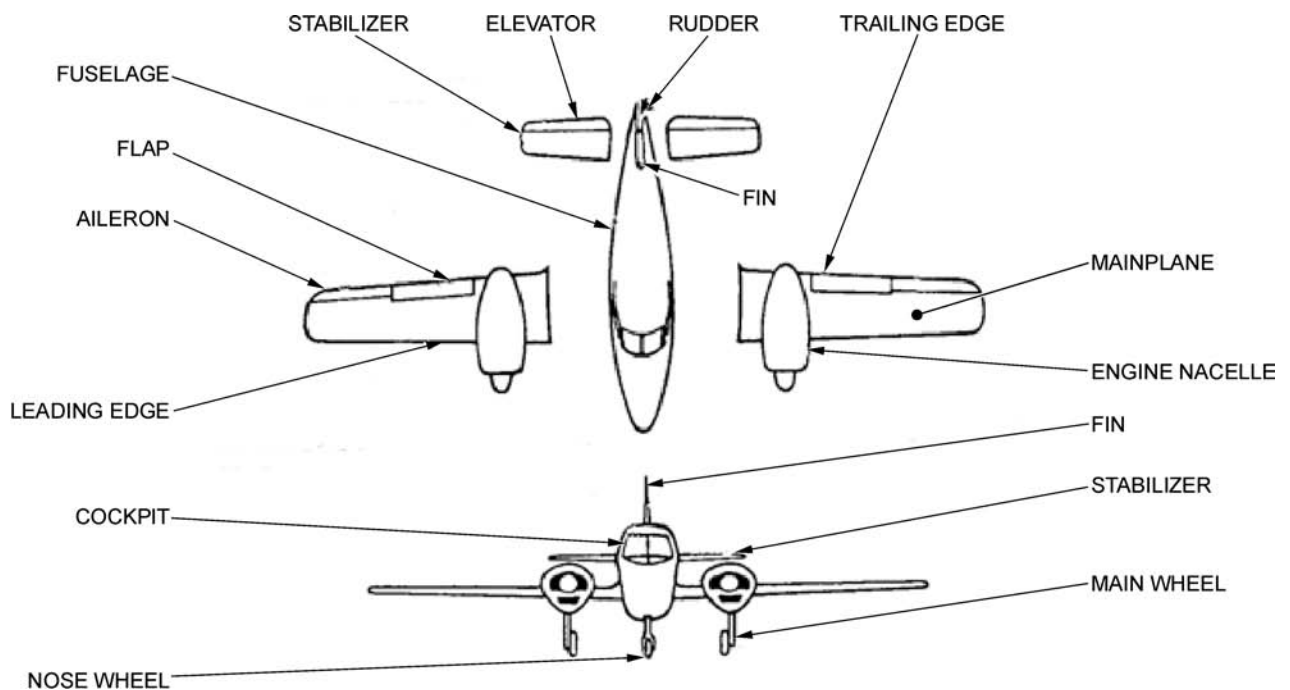

Level 1 Royal Canadian Air Cadet Handbook – A-CR-CCP-266/PT-001

Figure 12-3-1 Airplane Components

FUSELAGE

The fuselage is the body of the aircraft, designed to accommodate the crew, passengers and cargo. The cockpit or crew flight deck is the part of the fuselage where the pilot and flight crew operate the aircraft. The fuselage is the structural body to which the wings, the tail section, landing gear and (in most small aircraft) the engine are attached.

WINGS

The fuselage is fitted with a wing on both sides. The primary purpose of the wings is to support the aircraft in flight by producing lift.

The wing root is where the wing meets the fuselage. The wing tip is the part farthest from the fuselage.

The leading edge is the front edge of the wing running from wing root to wing tip. The trailing edge is the back edge of the wing running from wing root to wing tip.

Ailerons are moveable surfaces that are hinged to the trailing edge of each wing, close to the wing tip. The ailerons control roll. Roll is the banking of the aircraft to the left and the right. The ailerons move in opposite directions to each other.

Flaps are moveable surfaces that are hinged to the trailing edge of each wing, close to the wing root. They can be used during landing and take-off to provide more controlled flight at slower airspeeds. Flaps are operated with a lever or hand wheel in the cockpit.

EMPENNAGE

The empennage refers to the whole tail section of a plane. It includes the horizontal stabilizer, elevator, vertical stabilizer, and rudder.

The horizontal stabilizer is at the back of the aircraft, and helps keep the aircraft stable as it flies through the air. The horizontal stabilizer does not move.

The elevator is hinged to the horizontal stabilizer and is operated by moving the control column forward and backward. The elevator controls pitch. Pitch is the up and down movement of the aircraft's nose.

The vertical stabilizer, also called the fin, is an upright surface on the empennage. It helps keep the aircraft stable as it flies through the air. The vertical stabilizer does not move.

The rudder is hinged to the fin and is operated by the rudder pedals in the cockpit. The rudder controls yaw. Yaw is the side-to-side movement of the aircraft.

LANDING GEAR

Landing gear on an airplane is like the tires on a car. The landing gear supports the aircraft when it is on the ground and absorbs the shock of landing. All aircraft have their landing gear under the main part of the fuselage or wings. Landing gear can be fixed or retractable. Fixed gear is attached to the airplane in a permanent position. Retractable gear can fold up into the wings or the fuselage.

There are two main landing gear configurations. Both configurations have the main wheels or main gear toward the middle of the aircraft. In a nose wheel configuration (also called tricycle) there is another wheel or gear under the nose. In a tail wheel configuration (also called conventional or tail dragger) there is another wheel or gear under the tail.

PROPULSION SYSTEM

Power is produced by an internal combustion engine (the same as a car) with a two or three bladed propeller or a gas turbine (jet) engine. A jet can be used to power a propeller – this is called a turboprop engine.

The cowling (also called the nacelle) is like the hood of a car. It encloses the engine and streamlines the airplane to reduce drag. The cowling provides cooling of the engine by ducting cool air around the engine.

ACTIVITY – CONSTRUCT A MODEL AIRPLANE

Time: 45 min

OBJECTIVE

The objective of this activity is to confirm the cadets' comprehension of the information taught during EO M130.02 (Section 2). Cadets are to use their knowledge of components of an airplane and the materials provided to construct a model airplane.



The purpose of this model is to incorporate the major components as discussed in EO M130.02 (Section 2), NOT to build a flying model. With the propeller and landing gear attached, this model will be too heavy to fly. The assembly time provided in this lesson does not allow sufficient drying time to produce an airworthy model. Aerodynamic features of assembly have been omitted for simplicity.

RESOURCES

- Paper model templates (one per cadet).

- Instruction sheet found in Annex G (one per cadet).
- Thumbtacks (one per cadet).
- One inch binder clips (one per cadet).
- Scissors (one pair per cadet).
- Glue sticks (one stick per two cadets).
- Markers (to be shared by all cadets).



The instructor should have a completed paper model for demonstration/confirmation purposes.

ACTIVITY LAYOUT



Cadets are to complete the models on their own by following the instruction sheets provided in Annex G.

- Each cadet will construct their own model airplane. The materials for each model include:
 - a template;
 - a thumbtack; and
 - a one inch binder clip.
- Each cadet will also need to use scissors, a glue stick, and markers. Provide cadets with the instructions sheet provided in Annex G. The instructions include the following steps:
 1. Cut out all the airplane pieces. Cadets must be careful not to mix their pieces with others around them.
 2. To assemble the fuselage, glue pieces 1F through 7R and 7L to build-up fuselage layers, carefully aligning parts. Ensure that the entire contacting surface of a smaller piece being fastened to a larger one is completely covered with glue.

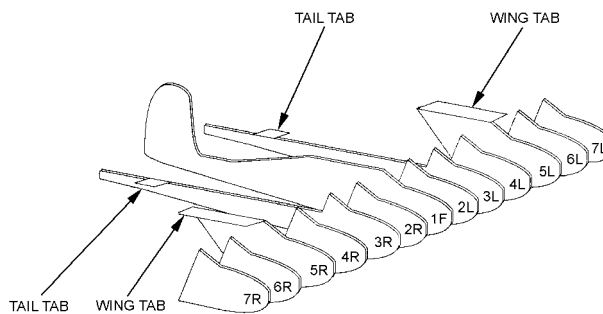

Adapted From Fabulous Paper Gliders

Figure 12-3-2 Fuselage Assembly

3. To assemble the wings, glue 9M to the bottom of wing part 8W. Then glue 10B to the bottom of 9M. Make sure the wing parts are aligned along the centre line. Fold down the wing tabs on the fuselage, and apply glue to them. Fasten the wing assembly to the fuselage.

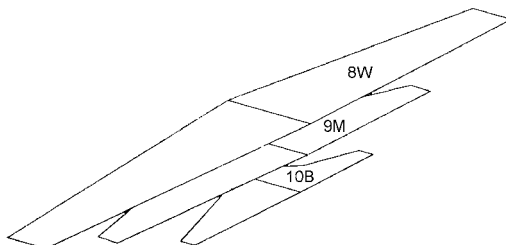

Adapted From Fabulous Paper Gliders

Figure 12-3-3 Wing Assembly

4. To assemble the tail, fold down the tail tabs on the fuselage, and apply glue to them. Fasten the horizontal stabilizer 11S to the fuselage.

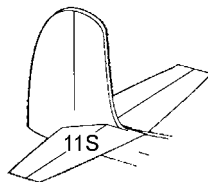

Adapted From Fabulous Paper Gliders

Figure 12-3-4 Tail Assembly

5. To attach the propeller, pierce the centre of 12P with the thumbtack, and push the thumbtack into the centre of the fuselage assembly.

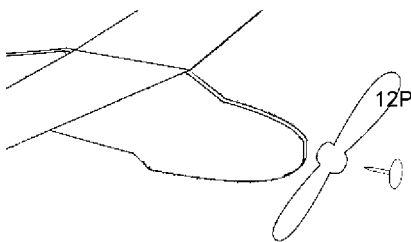

Adapted From Fabulous Paper Gliders

Figure 12-3-5 Propeller Assembly

6. To attach the landing gear, clip the binder clip to the bottom of the fuselage, underneath the wings.

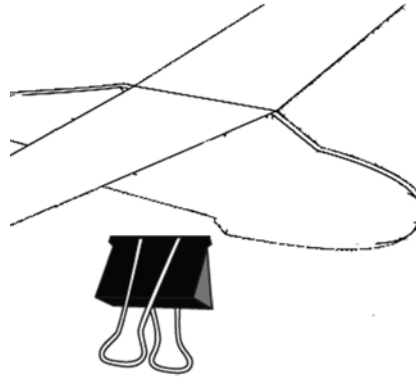

Adapted From Fabulous Paper Gliders

Figure 12-3-6 Landing Gear Assembly

7. Color the model as desired.
8. Clean-up, discarding all scrap paper and returning materials to the instructor.

SAFETY

Care should be taken when handling the thumbtacks, scissors, and glue.

INSTRUCTOR GUIDELINES

- Supervise the cadets' work to ensure that they are following the instructions provided.
- While supervising and assisting as needed, ask cadets to identify parts of the airplane.
- Ensure cadets identify the leading and trailing edges of the wings and attach the wings facing the correct direction.
- Once the activity has been completed, examine the model airplanes to ensure that all of the components are assembled correctly.
- After this activity has been completed, carry on with the reflection/questioning stage.
- Ask other instructors to assist in supervising the activity and assisting in answering questions.

REFLECTION

Time: 5 min

GROUP DISCUSSION



Instructor shall ensure that all lesson objectives are drawn out towards the end of the reflection stage.

DISCUSSION QUESTIONS



TIPS FOR ANSWERING/FACILITATING DISCUSSION

- Ask questions that help facilitate discussion; in other words, avoid questions with yes or no answers.
- Prepare questions ahead of time.
- Be flexible (you are not bound to only the prepared questions).
- Encourage cadets to participate by using praise such as “great idea” or “excellent response, can anyone add to that?”.
- Try to involve everyone by directing questions to non-participants.

SUGGESTED QUESTIONS

- Q1. What did you learn about airplane parts from this activity?
- Q2. How did this activity help you understand airplanes better?

CONCLUSION

REVIEW

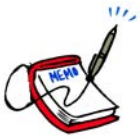

Review the components of an airplane with the following questions, using the model created by the cadets as a training aid. Point out the various components of an airplane discussed in the previous class. Below are some questions that can supplement this review.

SUGGESTED QUESTIONS

- Q1. What is the purpose of the landing gear?
- Q2. Where are the ailerons located?
- Q3. What movement does the rudder produce?
- Q4. What is the purpose of the cowling?

SUGGESTED ANSWERS

- A1. The landing gear supports the aircraft when it is on the ground and absorbs the shock of landing.
- A2. Ailerons are hinged to the trailing edge of each wing, close to the wing tip.
- A3. The rudder controls the movement called yaw. Yaw is the side-to-side movement of the aircraft.
- A4. The cowling encloses the engine and streamlines the airplane to reduce drag. The cowling provides cooling of the engine by ducting cool air around the engine.

MAIN TEACHING POINTS

- TP1. Describe the components of an airplane.



Instructors shall reinforce those answers and comments discussed during reflection, but must ensure that the main teaching points have been covered. Any main teaching point not brought out during the guided discussion shall be inserted during review.

HOMEWORK/READING/PRACTICE

N/A.

METHOD OF EVALUATION

There is no formal assessment of this EO.

CLOSING STATEMENT

Model building is an excellent opportunity to apply theoretical knowledge. Being able to identify and describe the main components of an airplane will allow cadets to more actively participate in further aviation topics.

INSTRUCTOR NOTES/REMARKS

N/A.

REFERENCES

- A3-001 A-CR-CCP-263/PT-001, *From the Ground Up: Millennium Edition (2000)*. Ottawa, ON: Aviation Publishers Co. Limited.
- C3-017 (ISBN 1-895569-23-0) Schmidt, N. (1998). *Fabulous Paper Gliders*. Sterling Publishing: New York, NY.

THIS PAGE INTENTIONALLY LEFT BLANK



ROYAL CANADIAN AIR CADETS

LEVEL ONE

INSTRUCTIONAL GUIDE



SECTION 4

EO M130.04 – WATCH *ON CANADIAN WINGS* VIDEO

Total Time:

30 min

INTRODUCTION

PRE-LESSON INSTRUCTIONS

A complete list of resources needed for the instruction of this EO is located at Chapter 2 of the QSP. Specific uses for said stores are identified throughout the Instructional Guide, within the teaching point for which they are required.



This mandatory period consists of one of the videos. The remainder of the videos may be viewed during complementary periods.

Prior to instructing this lesson the instructor is required to:

- review the lesson content, and become familiar with the material;
- prepare a suitable classroom area;
- prepare a TV/VCR for video viewing; and
- obtain the tape entitled *On Canadian Wings*.

PRE-LESSON ASSIGNMENT

N/A.

APPROACH

The group discussion method was chosen to allow the cadets to share their knowledge, opinions, and feelings about the subject matter while still allowing the instructor to control the direction of the discussion. The instructor must ensure that points not brought forth by the class are presented. If the instructor follows the Instructional Guide, including the questions posed, this will allow the cadets to express, in their own words, what they learned from this lesson and how they may apply the information.

REVIEW

N/A.

OBJECTIVES

By the end of this lesson the cadet shall be expected to be familiar with Canadian aviation history by participating in a discussion on episodes from the film *On Canadian Wings*.

IMPORTANCE

Discovering Canadian aviation history will give cadets a better understanding of the current role of aviation in Canada. Knowledge gained in this lesson will assist in stimulating an interest in the air element of the Canadian Forces.

BACKGROUND KNOWLEDGE

EPISODE: CANADA'S FIRST FLIGHT

The shaky flights of flying machines sow the seeds for military aviation. Soon hundreds of Canadian flying cadets are showing dash in their biplanes. Canada's first aircrews are on their way to war.

Length (00:13:26)

EPISODE: AERIAL WARFARE

Canadian aircrews serve in fighter squadrons at Dunkirk and go into action against German Zeppelins, seaplanes and U-boats. Canadian flying aces like Major Billy Bishop, Major Raymond Collishaw and Major Billy Barker become household names.

Length (00:12:22)

EPISODE: THE BIRTH OF A NATIONAL AIR FORCE

With little fanfare, the RCAF comes into being on 1 April 1924. As war clouds loom over Europe, the new Air Force is on active service. The RCAF grows to the fourth largest Air Force of the allied nations.

Length (00:11:58)

EPISODE: THE AERODROME OF DEMOCRACY

Canadian squadrons see sustained combat in The Battle of Britain and help to keep the sea lanes from Canada to England open. RCAF schools across Canada train more than 150 000 Commonwealth air and groundcrews.

Length (00:12:48)

EPISODE: SOME OF THE FEW

Flying aces F/L Buzz Beurling, Wing Commander Johnnie Johnson and F/L D.E. Hornell are immortalized with a string of spectacular wartime successes.

Length (00:12:22)

EPISODE: BOMBS OVER EUROPE

The famous No. 6 Bomber Group is formed as the bomber offensive heats up over Europe. S/L Ian Bazalgette and P/O Andrew Mynarski earn Victoria Crosses.

Length (00:12:55)

EPISODE: FAST TIMES FOR THE GOLDEN JETS

Canadian aircrews are again involved in combat over Korea. The Golden Hawks formation flying team of F86 Sabres – the Spitfires of the jet age, dazzle audiences around the world.

Length (00:12:37)

EPISODE: A TIME OF TRANSITION

Canada develops the Avro Arrow – a supersonic jet fighter that could outfly anything in the world. The Diefenbaker government mysteriously cancels the project and destroys all drawing and prototypes.

Length (00:11:57)

EPISODE: THERE SHALL BE WINGS

Canada's Air Force support NATO and UN operations in the Balkans, the Middle East, Africa, Central America and Haiti, and humanitarian relief worldwide.

Length (00:13:00)

REFLECTION

Time: 10 min

Method: Group Discussion

GROUP DISCUSSION

Instructor shall ensure that all lesson objectives are drawn out towards the end of the reflection stage.

DISCUSSION QUESTIONS**TIPS FOR ANSWERING/FACILITATING DISCUSSION**

- Ask questions that help facilitate discussion; in other words, avoid questions with yes or no answers.
- Prepare questions ahead of time.
- Be flexible (you are not bound to only the prepared questions).
- Encourage cadets to participate by using praise such as “great idea” or “excellent response, can anyone add to that?”.
- Try to involve everyone by directing questions to non-participants.

SUGGESTED QUESTIONS AND ANTICIPATED ANSWERS:***Canada's First Flight***

- Q1. Who were the founding members of the Aerial Experimental Association?
- Q2. What was the name of the aircraft they initially used?
- Q3. In which year did the first aviation policy appear?
- Q4. How many people were members of the Canadian aviation corps?
- A1. Alexander Graham Bell, J.A.D. McCurdy, Casey Bothman.
- A2. The Silver Dart.

A3. 1907.

A4. 3 people.

Aerial Warfare

Q1. How long did the strategic bombing campaign last?

Q2. How many Zeppelins were destroyed during WWI? How many by Canadians?

Q3. Who was Billy Bishop and what did he do?

A1. 1 year.

A2. 12 destroyed, 6 of them by Canadians.

A3. Billy Bishop was one of the first Canadian aviation aces. He had 72 confirmed victories and was decorated with the Victoria Cross.

The Birth of a National Air Force

Q1. What major event occurred in 1920?

Q2. What was the goal of military aviation at that time?

Q3. Where was the largest pilot training camp situated?

Q4. In 1937 the RCAF was given a very precise mandate, what was that mandate?

A1. The CAF was dismantled.

A2. Cartography, medical evacuations, ice patrols, surveillance and fighting forest fires.

A3. Borden, Ontario.

A4. To defend Canadian airspace.

The Aerodrome of Democracy

Q1. What was Canada's role at the beginning of WWII?

Q2. Most of the pilots were trained on which aircraft?

Q3. How many squadrons were initially based in Halifax?

Q4. How many U-boats did the RCAF sink?

A1. Canada was an immense centre of pilot training for the Commonwealth nations.

A2. Tiger moth.

A3. 5.

A4. 27.

Some of the Few

Q1. Name the ace of Canadian aces during WWII?

Q2. Which Canadian squadron was victorious over the most enemy aircraft in 1944 and how many aircraft did they shoot down?

Q3. Name the two new types of aircraft used by Canada as the end of the war approached.

A1. Buzz Beurling.

A2. 418 squadron with 103 confirmed victories.

A3. Mustang, Typhoon, Mosquito.

Bombs over Europe

Q1. What was the first Canadian bomber squadron and when was it created?

Q2. Which bombers did Canadians use?

Q3. Who was the commander of the first all Canadian squadron in Great Britain?

A1. 405 squadron was formed in April 1941.

A2. Wellington, Halifax, Lancaster, Liberator, and Mosquito.

A3. Johnny Fauquier.

Fast Times for the Golden Jets

Q1. In 1948, Canada acquired numerous aircraft. What were they and how many were acquired?

Q2. Canada was divided, due to resources, into several search and rescue regions. How many regions and how many aircraft were assigned to this task?

Q3. What was the name of the aircraft and the training base used in the formation of the first military aviation demonstration team?

Q4. Canada began the construction of its own all Canadian aircraft. What was its name?

A1. 85 Vampires.

A2. 5 regions and 34 aircraft.

A3. Blue Devils, Vampire, St-Hubert (QC).

A4. CF-100 Canuck.

A Time of Transition

Q1. What aircraft was supposed to replace the CF-100?

Q2. Following the failure of the Avro Arrow, which aircraft did Canada buy?

Q3. What major event occurred in 1968?

Q4. New aircraft appeared during this period. Name at least three of them.

A1. The Avro Arrow.

A2. CF-101 Voodoo.

A3. The unification of the three branches of the Canadian Forces.

A4. Caribou, Buffalo, Hercules, Tutor, Dassault Falcon, Sea King, CF-5 Freedom Fighter.

There Shall be Wings

- Q1. In which year was the aerial command group formed?
- Q2. In which year did the first CF-18 (CF-188 Hornet) arrive in Canada?
- Q3. How many Canadian CF-18s were sent to serve during the Gulf War?
- A1. 1975.
- A2. 1981.
- A3. 24.



Other questions and answers will develop throughout the reflection stage. The discussion should not be limited to only those suggested.

CONCLUSION

REVIEW

Upon completion of the guided discussion the instructor will conclude by summarizing the discussion to ensure that all teaching points have been covered. The instructor must also take this opportunity to explain how the cadet will apply this knowledge and/or skill in the future.



Instructors shall reinforce those answers and comments discussed during reflection, but must ensure that the main teaching points have been covered. Any main teaching points not brought out during the guided discussion shall be inserted during review.

HOMEWORK/READING/PRACTICE

N/A.

METHOD OF EVALUATION

There is no formal assessment of this EO.

CLOSING STATEMENT

Discovering Canadian aviation history will give cadets a better understanding of the current role of aviation in Canada. Knowledge gained in this lesson will assist in stimulating an interest in the air element of the Canadian Forces.

INSTRUCTOR NOTES/REMARKS

N/A.

REFERENCES

C3-039 Squires, C. (1999). *On Canadian Wings* [Series]. Winnipeg, MB: PWGSC.



ROYAL CANADIAN AIR CADETS

LEVEL ONE

INSTRUCTIONAL GUIDE



SECTION 5

EO C130.01 – PARTICIPATE IN A WALK-AROUND AIRCRAFT INSPECTION

Total Time:	30 min
-------------	--------

INTRODUCTION

PRE-LESSON INSTRUCTIONS

This EO can be coordinated with familiarization flying or a local aerodrome tour.

A complete list of resourced needed for the instruction of this EO is located at Chapter 2 of the QSP. Specific uses for said stores are identified throughout the Instructional Guide, within the teaching point for which they are required.

Prior to instructing this lesson the instructor shall:

- review the lesson content, and become familiar with the material;
- ensure access to a single engine, non-high performance airplane; and
- arrange for one qualified pilot per 10 cadets (maximum group size) to conduct the inspection.

PRE-LESSON ASSIGNMENT

N/A.

APPROACH

The small group activity was selected to allow for maximum participation in the learning process. It is an interactive way to illustrate and substantiate the lesson material in a concrete manner.

The group discussion method was chosen to allow the cadets to share their knowledge, opinions, and feelings about the subject matter while still allowing the instructor to control the direction of the discussion. The instructor must ensure that points not brought forth by the class are presented. If the instructor follows the Instructional Guide, including the questions posed, this will allow the cadets to express, in their own words, what they learned from this lesson and how they may apply the information.

REVIEW

The pertinent review for this lesson will include:

- describe the fuselage (EO M130.02 [Section 2] TP2);
- describe the wings (EO M130.02 [Section 2] TP3);
- describe the empennage (EO M130.02 [Section 2] TP4);
- describe the landing gear (EO M130.02 [Section 2] TP5); and

- describe the propulsion system (EO M130.02 [Section 2] TP6).

OBJECTIVES

By the end of this lesson the cadet shall have participated in an aircraft walk-around inspection.

IMPORTANCE

Carefully inspecting an airplane before flight is one way the pilot ensures that the airplane is operational and safe. The walk-around inspection is an opportunity to apply knowledge of major airplane components. It is an excellent introduction to the culture of safety that surrounds aviation.

BACKGROUND KNOWLEDGE



This information is representative only. Always refer to and follow the recommendations of the manufacturer in carrying out any inspections and procedures. Individual models of airplanes may have special procedures and inspection guidelines that will vary from the information given in this guide.

GENERAL

Flight safety includes the possession of knowledge, using common sense, and self-discipline. Thorough inspections and following established procedures allows a pilot to ensure that important safety considerations are not overlooked. One of these practices is conducting a walk-around inspection of the aircraft before a flight. The purpose of the walk-around is to notice any damage or condition that may pose a safety hazard to the flight. A walk-around can identify problems early in the flight preparation process, so that changes can be made if necessary (minor repairs, changing aircraft, etc.). If any damage is noticed, it should be brought to the attention of an aircraft maintenance engineer, and noted in the aircraft's technical logbook. It is ultimately the pilot's decision whether an aircraft is in condition to fly. It is always better to make a decision on the side of safety, than to be caught in a potentially dangerous situation while flying.

CABIN

Before beginning the external inspection of the airplane, there are some preparatory things to be done inside the cabin.

Control locks should be removed. The control lock is a device that makes the control column/yolk immobile, so that the control surfaces (ailerons and elevators) do not move in the wind.

The pilot should ensure that the ignition is off, to avoid an unintended engine start.

The master switch controls power to the electrical systems in the airplane. The master switch should be turned on to supply power to the fuel gauges and the flaps. The fuel level indicated on the fuel gauges should be noted. This indicated level will be cross-checked with a visual check of the actual fuel levels. The flaps should be fully lowered. The master switch should then be turned off to avoid draining the battery.

WINGS

Aircraft that are parked outside overnight are usually tied down to anchors beneath the wings and tail. The wing tie-downs should be removed from the airplane. There may be external control locks placed over the ailerons to prevent movement. These should be removed.

The flap sliders should be inspected to ensure secure attachment and minimal "play" or unwanted freedom of movement.

The aileron attachment points should be inspected to ensure security. The ailerons should be moved through their full range of motion to confirm correct and free movement.

All wing surfaces, the leading edge, and the trailing edge should be checked for dents, tears, cracks, wrinkles, bulges or missing rivets.

A small amount of fuel should be drained from the fuel tank drain valve and visually checked to see if there is any water or sediment in the fuel. Water will appear as bubbles at the bottom of the cup as water is heavier than fuel. The fuel should also be checked to see that it is the correct fuel grade. Different grades of fuel are different colours. One hundred low-lead is the fuel grade most commonly used in light aircraft, and is coloured blue.

The fuel levels should be visually confirmed by removing the fuel cap and using a dipstick. The fuel cap must be properly secured after checking the fuel.

The Pitot tube is connected to the instruments in the cockpit. In order for it to work properly, it must be clear of obstructions.

FUSELAGE

The baggage compartment should be checked to see if there is anything stored there that may be required for the flight, such as a survival kit. Knowing what is on board the airplane is important for calculating the weight and balance.

All fuselage surfaces should be checked for dents, tears, cracks, wrinkles, bulges or missing rivets.

The static port is connected to the instruments in the cockpit. In order for it to work properly, it must be clear of obstructions.

EMPENNAGE

If the aircraft is tied down, the tie-downs from the tail must be removed. External control locks should be removed.

All empennage surfaces should be checked for dents, tears, cracks, wrinkles, bulges or missing rivets.

The rudder and elevator attachment points should be inspected to ensure security. The rudder and elevator should be moved through their full ranges of motion to confirm correct and free movement.

LANDING GEAR

Wheel chocks are used to keep the airplane from rolling while parked. They should be removed.

The wheels and brakes should be checked to ensure there is no excessive wear or fluid leaks.

The tires should be checked to ensure they are properly inflated and there are no signs of excessive wear or damage.

ENGINE

Extra caution should always be exercised around the propeller arc. The propeller should be checked for damage or evidence of a propeller strike. This could indicate damage to the engine.

The openings to the cowling should be checked for obstructions, particularly bird or animal nests.

The oil level is checked with a dipstick, and should be within the prescribed limits. The cap and dipstick must be secured after checking the oil.

A small amount of fuel should be drained from the main fuel strainer to clear any water or sediment that may have accumulated.

ACTIVITY

Time: 20 min



This activity should be conducted by a qualified pilot for safety reasons. If the pilot is not a squadron instructor, have a squadron instructor supervise the inspection.

OBJECTIVE

This activity is designed to familiarize the cadet with the procedures of a walk-around aircraft inspection.

RESOURCES

- single engine, non-high performance airplane.
- operator's manual inspection checklist for the particular aircraft type.
- fuel dipstick.
- fuel drain cup.

ACTIVITY LAYOUT

1. This activity should be conducted in groups of ten or less cadets. All cadets must be briefed on the safety guidelines before beginning the inspection.
2. If there is more than one group inspecting one plane, they should start at opposite points (i.e., opposite wings, or nose and tail).
3. The cadets should be guided through a complete walk-around inspection. The instructor/pilot should cover all of the relevant information provided in the background information section.

SAFETY

- Caution should always be exercised around the propeller arc.
- Cadets must be told what they can and cannot touch, and where they can and cannot go.
- Only the aircraft involved in the lesson should be touched.

INSTRUCTOR GUIDELINES

- The instructor/pilot should supervise the inspection to:
 - ensure all cadets actively participate;
 - correct inappropriate aircraft handling; and
 - ask cadets questions.
- The cadets should be involved in the inspection, handling objects and the aircraft wherever appropriate.

REFLECTION

Time: 5 min



Instructor shall ensure that all lesson objectives are drawn out towards the end of the reflection stage.

DISCUSSION QUESTIONS



TIPS FOR ANSWERING/FACILITATING DISCUSSION

- Ask questions that help facilitate discussion; in other words, avoid questions with yes or no answers.
- Prepare questions ahead of time.
- Be flexible (you are not bound to only the prepared questions).
- Encourage cadets to participate by using praise such as “great idea” or “excellent response, can anyone add to that?”.
- Try to involve everyone by directing questions to non-participants.

SUGGESTED QUESTIONS

- Q1. Why is it important to conduct a walk-around inspection?
- Q2. What would you do if you noticed damage to the airplane?
- Q3. How would you change the walk-around procedure if you were in a hurry to go flying? (You wouldn't! Procedures, checklists, and inspections are too important!)

CONCLUSION

HOMework/READING/PRACTICE

N/A.

METHOD OF EVALUATION

There is no formal assessment of this EO.

CLOSING STATEMENT

The walk-around inspection is one of the procedures followed to ensure the safety of a flight. Carefully following procedures like this on every flight is very important to ensure nothing is overlooked. Participating in a walk-around inspection is an excellent way for cadets to apply their knowledge of airplane components.

INSTRUCTOR NOTES/REMARKS

N/A.

REFERENCES

- A3-001 A-CR-CCP-263/PT-001, *From the Ground Up: Millennium Edition (28th Edition)*. (2000). Ottawa, ON: Aviation Publishers.



ROYAL CANADIAN AIR CADETS

LEVEL ONE

INSTRUCTIONAL GUIDE



SECTION 6

EO C130.02 – IDENTIFY INTERNATIONAL AIRCRAFT

Total Time: 30 min

INTRODUCTION

PRE-LESSON INSTRUCTIONS

A complete list of resources needed for the instruction of this EO is located at Chapter 2 of the QSP. Specific uses for said stores are identified throughout the Instructional Guide, within the teaching point for which they are required.

Prior to instructing this lesson the instructor is required to:

- review the lesson content, and become familiar with the material;
- prepare a suitable classroom area; and
- prepare puzzle activity for the end of lesson confirmation.

PRE-LESSON ASSIGNMENT

N/A.

APPROACH

The interactive lecture method was chosen as it allows the instructor to make a semi-formal presentation of the material where the cadets can participate by asking or responding to questions and commenting on the material. For this lesson, this method is most effective as it matches well the taxonomic level of the material and is age-appropriate by virtue of its participatory nature.

REVIEW

The pertinent review for this lesson may include an overview of military, civilian and cadet aircraft.

OBJECTIVES

By the end of this lesson the cadet shall be expected to identify the following aircraft:

- Lockheed-Martin F/A -22A Raptor;
- Fairchild Republic A-10 Thunderbolt II;
- Lockheed F-117A Nighthawk;
- Boeing B-52 Stratofortress;
- Eurofighter EF-2000 Typhoon;

- Sepecat Jaguar GR3;
- Mikoyan-Gurevich MiG-29; and
- Antonov AN-124-100.

IMPORTANCE

Being able to identify international aircraft will support the aim of stimulating an interest in the aviation community. Cadets will be able to use this knowledge when visiting an aerodrome, at a local air show, or while attending a CSTC.

Teaching Point 1

Describe American Aircraft

Time: 12 min

Method: Interactive Lecture

F/A-22A RAPTOR

The F/A-22A Raptor is the United States Air Force's (USAF) newest fighter aircraft. Its combination of stealth, supercruise, manoeuvrability and integrated avionics represents an exceptional leap in war fighting capabilities. Its primary role is air dominance. The Raptor performs both air-to-air and air-to-ground missions. Also, it produces more thrust than any current fighter. The combination of the increased thrust and its unique aerodynamic design allows the aircraft to cruise at supersonic speeds without using afterburner. The Raptor is manufactured by Lockheed Martin and is powered by two Pratt & Whitney F119-PW-100 turbofan engines with afterburners.



United States Air Force Website, <http://www.af.mil>

Figure 12-6-1 F/A-22A Raptor



United States Air Force Website, <http://www.af.mil>

Figure 12-6-2 F/A-22A Raptor

A-10 THUNDERBOLT II

The A-10 Thunderbolt II is the first USAF aircraft specially designed for close air support of ground forces. The A-10 can be used against all ground targets including tanks and other armoured vehicles. Its wide combat radius and short takeoff and landing capability permit operations in and out of locations near front lines. The Thunderbolt is distinguished by its 30 millimetres GAU-8/A Gatling gun. This weapon is mounted on the nose, can fire 3900 rounds per minute and can defeat an array of armoured vehicles. The A-10 is manufactured by Fairchild Republic Company and is powered by two General Electric TF34-GE-100 turbofans mounted high on the rear of the aircraft.



United States Air Force Website, <http://www.af.mil>

Figure 12-6-3 A-10 Thunderbolt II



United States Air Force Website, <http://www.af.mil>

Figure 12-6-4 A-10 Thunderbolt II

F-117A NIGHTHAWK

The F-117A Nighthawk is the world's first operational aircraft designed to use low observable stealth technology. This technology allows the aircraft to not be easily detected by radar. This precision strike aircraft penetrates high threat airspace and uses laser-guided weapons systems against critical targets. The Nighthawk created a revolution in military warfare by incorporating low observable technology into operational aircraft. It has a sleek design that allows for its stealth technology to be very effective. The F-117A is manufactured by Lockheed Martin and is powered by two GE F404 non-afterburning engines.



United States Air Force Website, <http://www.af.mil>

Figure 12-6-5 F-117A Nighthawk



United States Air Force Website, <http://www.af.mil>

Figure 12-6-6 F-117A Nighthawk

B-52 STRATOFORTRESS

The B-52 is a long-range heavy bomber that can perform a variety of missions. The bomber is capable of flying at high subsonic speeds at altitudes up to 50 000 feet. It can carry nuclear or precision-guided weapons. The B-52 is a large aircraft with a length of 159 feet 4 inches and a wingspan that measures 185 feet. The Stratofortress is manufactured by Boeing Military Airplane Company and is powered by eight Pratt & Whitney TF33-P-3/103 turbofan engines.



United States Air Force Website, <http://www.af.mil>

Figure 12-6-7 B-52 Stratofortress



United States Air Force Website, <http://www.af.mil>

Figure 12-6-8 B-52 Stratofortress

CONFIRMATION OF TEACHING POINT 1

QUESTIONS

- Q1. How long is the wingspan of the B-52 Stratofortress?
- Q2. What is distinctive about the A-10 Thunderbolt II?
- Q3. What type of weapons systems does the F-117A Nighthawk use against critical targets?

ANTICIPATED ANSWERS

- A1. 185 feet.
- A2. The nose mounted 30 millimetres Gatling gun.
- A3. Laser guided.

Teaching Point 2

Time: 6 min

Identify British Aircraft

Method: Interactive Lecture

EF-2000 TYPHOON

The Typhoon is an agile, single seat, multi-role aircraft optimized for high altitude supersonic air combat. It is also capable of operating at lower levels in an air-to-ground role. Its low weight and high thrust means it can reach 36 000 feet in less than two minutes from a standing start. The engine intake is mounted on the bottom of the fuselage. A tall sharply swept tail is at the rear of the fuselage with twin-engine pipes directly below. The Typhoon is manufactured by Eurofighter and is powered by two Eurojet EJ200 turbofan engines.



Royal Air Force image Website, <http://www.defenceimages.mod.uk>

Figure 12-6-9 EF-2000 Typhoon



Royal Air Force image Website, <http://www.defenceimages.mod.uk>

Figure 12-6-10 EF-2000 Typhoon



Royal Air Force image Website, <http://www.defenceimages.mod.uk>

Figure 12-6-11 EF-2000 Typhoon

JAGUAR GR3

The Jaguar is a dual-role advanced operational trainer and tactical support aircraft. It is a fighter-bomber that is capable of using 1000 pound general-purpose bombs that are guided to their targets by lasers. The Jaguar has a long sleek fuselage with a large swept tail fin and rudder. It has short-span swept wings that are mounted on top of the fuselage. The internal jet engines have intakes on either side of the fuselage behind the cockpit. The raised bubble canopy is set above the sharply pointed nose. The Jaguar is manufactured by Sepecat and is powered by two Rolls-Royce Adour turbofan engines.



Airliners.net, <http://www.airliners.net>

Figure 12-6-12 Jaguar GR3



Airliners.net, <http://www.airliners.net>

Figure 12-6-13 Jaguar GR3

CONFIRMATION OF TEACHING POINT 2

QUESTIONS

- Q1. Where is the Typhoon's sharply swept tail located?
- Q2. Where is the engine intake mounted on the Typhoon?
- Q3. Where is the canopy located on the GR3 Jaguar?

ANTICIPATED ANSWERS

- A1. At the rear of the upper fuselage.
- A2. On the underside of the fuselage.
- A3. Above the sharply pointed nose.

Teaching Point 3

Time: 6 min

Identify Russian AircraftMethod: Interactive Lecture

MIG-29 FULCRUM

The MiG-29 Fulcrum is an all weather, single seat fighter interceptor flown by the Russian Air Force. The MiG-29's wings are swept back and tapered with square tips. It is equipped with twin jet engines mounted low and to the sides of the fuselage. Diagonal shaped air intakes give the aircraft a box like appearance. The fuselage is made of a long, thin, slender body. The MiG-29 is manufactured by the Moscow Air Production Organization and is powered by two Klimov/Sarkisov RD-33 turbofans.



Airliners.net, <http://www.airliners.net>

Figure 12-6-14 MiG-29 Fulcrum



Airliners.net, <http://www.airliners.net>

Figure 12-6-15 MiG-29 Fulcrum

ANTONOV AN-124-100

The Antonov AN-124-100 is a civil certified long-range commercial freighter. It is widely used for the carriage of outsize and very heavy pieces of air cargo that other aircraft cannot accommodate. Pieces of cargo have included the space launcher, satellites, helicopters, large wheeled vehicles and a 109 tonne locomotive. The AN-124 has the largest payload and the largest interior of any airplane in the world. It features a double deck fuselage layout with the upper deck containing the cockpit and personnel compartments. The lower deck is a massive pressurized cargo compartment. The AN-124 is manufactured by O.K. Antonov and is powered by four D-18T Series 3 engines.



Airliners.net, <http://www.airliners.net>

Figure 12-6-16 Antonov AN-124-100



Airliners.net, <http://www.airliners.net>

Figure 12-6-17 Antonov AN-124-100

CONFIRMATION OF TEACHING POINT 3

QUESTIONS

- Q1. How are the MiG-29 Fulcrum's wings shaped?
- Q2. Name one of the large pieces of cargo the AN-124 has carried.
- Q3. What is the MiG-29's fuselage made of?

ANTICIPATED ANSWERS

- A1. Swept back and tapered with square tips.
- A2. The space launcher, satellites, helicopters, large wheeled vehicles and a 109 tonne locomotive.
- A3. A long, thin, slender body.

END OF LESSON CONFIRMATION

ACTIVITY

Time: 5 min

OBJECTIVE

The objective of this activity is to have cadets construct puzzles of international aircraft. This will confirm the teaching points delivered in this lesson.

RESOURCES

- Puzzles.

- Envelopes.
- Scotch tape.

ACTIVITY LAYOUT

- Prior to the lesson, the instructor shall write several characteristics or facts about the eight aircraft discussed in this lesson on the back of the corresponding picture attached at Annex I.
- Cut each picture into a separate puzzle.
- Place two puzzles into each envelope.
- Divide cadets into small groups.
- Distribute an envelope to each group.
- Direct cadets to remove the puzzles from the envelope and complete them.
- When cadets have successfully completed both puzzles, have them tape the pieces together to form two complete pictures.
- Have each group identify both aircraft and present the characteristics printed on the back of each picture to the remainder of the class.

SAFETY

N/A.

INSTRUCTOR GUIDELINES

- Effectively supervise the activity.
- Ensure cadets complete this activity within the time allotted.

CONCLUSION

HOMEWORK/READING/PRACTICE

N/A.

METHOD OF EVALUATION

There is no formal assessment of this EO.

CLOSING STATEMENT

Cadets have identified American, British and Russian aircraft. Being able to identify these aircraft will support the aim of stimulating an interest in the aviation community. Cadets will be able to use this knowledge when visiting an aerodrome, when at a local air show, or while attending CSTC Training.

INSTRUCTOR NOTES/REMARKS

N/A.

REFERENCES

C3-009 United States Air Force. (2006). Retrieved 21 March 2006, from <http://www.af.mil/factsheets.asp>.

- C3-010 Royal Air Force. (2006). Retrieved 20 March 2006, from <http://www.raf.mod.uk/equipment.html>.
- C3-011 Federation of American Scientists. (2006) Retrieved 21 March 2006, from <http://www.fas.org/nuke/guide/russia/airdef/mig-29.htm>.
- C3-012 Antonov Airlines. (2006). Retrieved 21 March 2006, from <http://www.antonovairlines.co.uk/antonov/military-logistics/antonov-124.asp>.

THIS PAGE INTENTIONALLY LEFT BLANK

AIRCRAFT IDENTIFICATION ACTIVITY

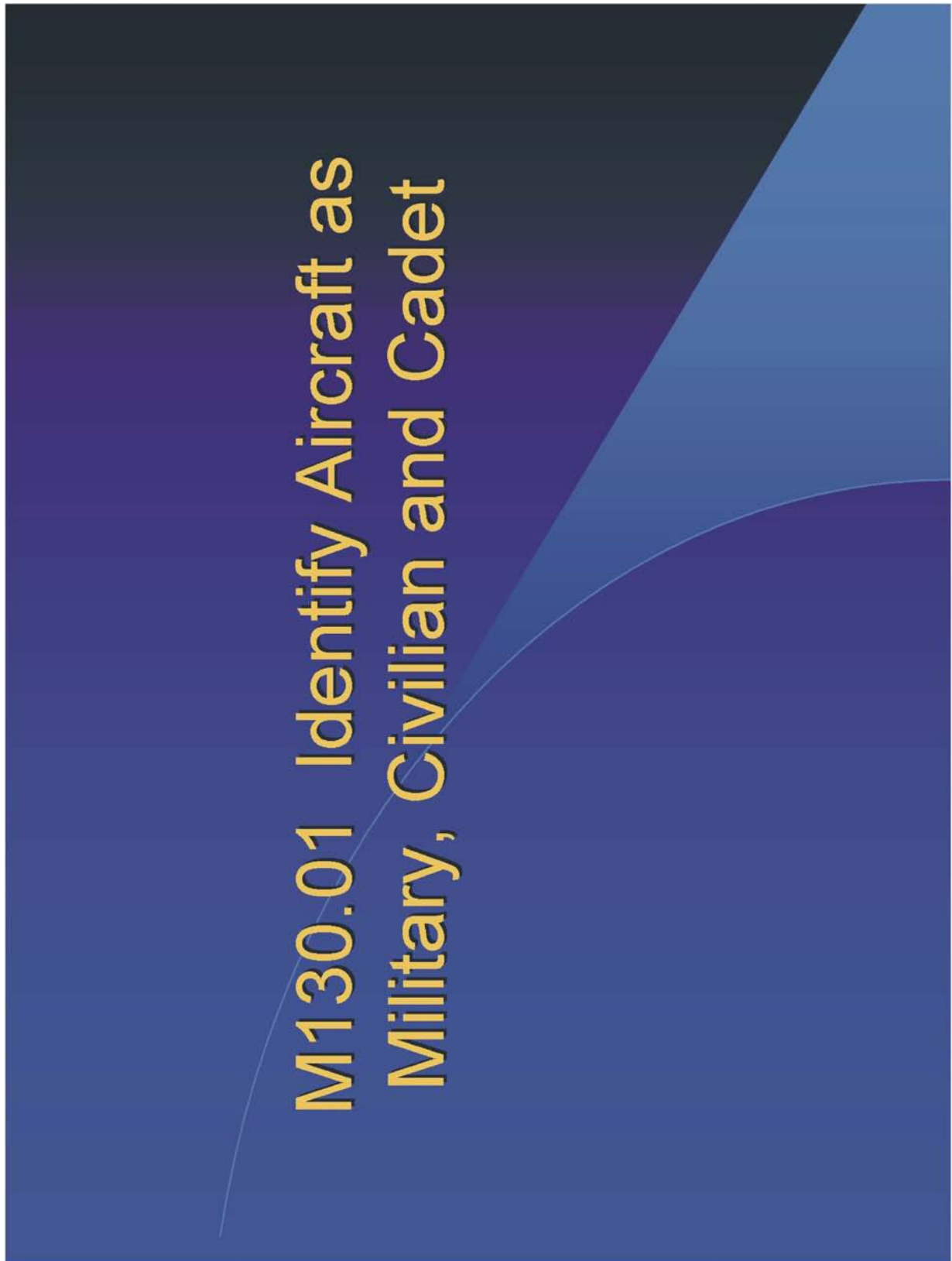

Figure 12A-1 Slide No. 1



Figure 12A-2 Slide No. 2



Figure 12A-3 Slide No. 3



Figure 12A-4 Slide No. 4



Figure 12A-5 Slide No. 5



Figure 12A-6 Slide No. 6



Figure 12A-7 Slide No. 7



Figure 12A-8 Slide No. 8



Figure 12A-9 Slide No. 9



Figure 12A-10 Slide No. 10



Figure 12A-11 Slide No. 11



Figure 12A-12 Slide No. 12



Figure 12A-13 Slide No. 13

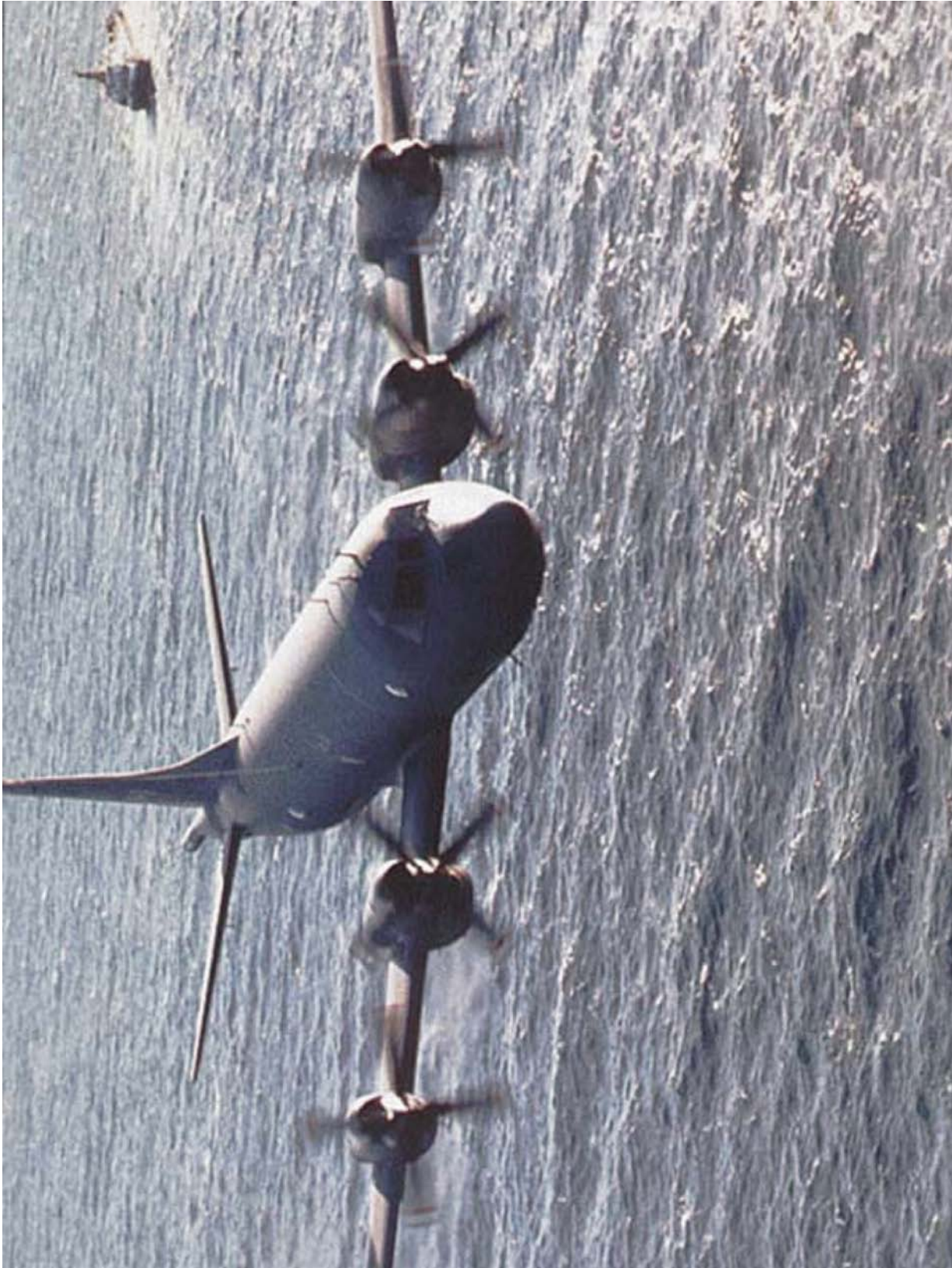

Figure 12A-14 Slide No. 14

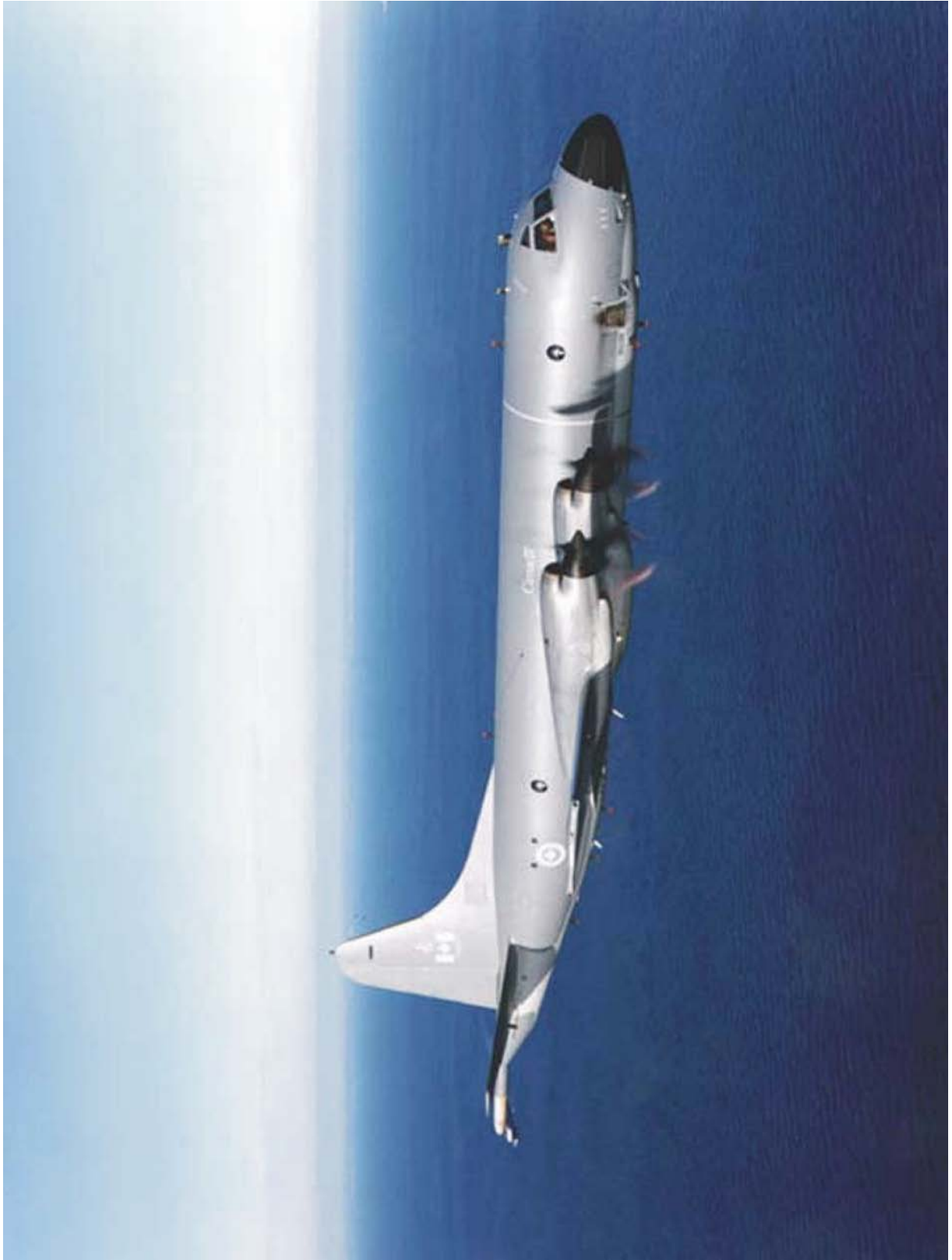

Figure 12A-15 Slide No. 15



Figure 12A-16 Slide No. 16



Figure 12A-17 Slide No. 17



Figure 12A-18 Slide No. 18



Figure 12A-19 Slide No. 19



Figure 12A-20 Slide No. 20



Figure 12A-21 Slide No. 21



Figure 12A-22 Slide No. 22



Figure 12A-23 Slide No. 23



Figure 12A-24 Slide No. 24



Figure 12A-25 Slide No. 25



Figure 12A-26 Slide No. 26



Figure 12A-27 Slide No. 27



Figure 12A-28 Slide No. 28



Figure 12A-29 Slide No. 29



Figure 12A-30 Slide No. 30



Figure 12A-31 Slide No. 31



Figure 12A-32 Slide No. 32



Figure 12A-33 Slide No. 33



Figure 12A-34 Slide No. 34



Figure 12A-35 Slide No. 35



Figure 12A-36 Slide No. 36



Figure 12A-37 Slide No. 37



Figure 12A-38 Slide No. 38

AIRCRAFT PICTURES



Figure 12B-1 Slide No. 1



Figure 12B-2 Slide No. 2

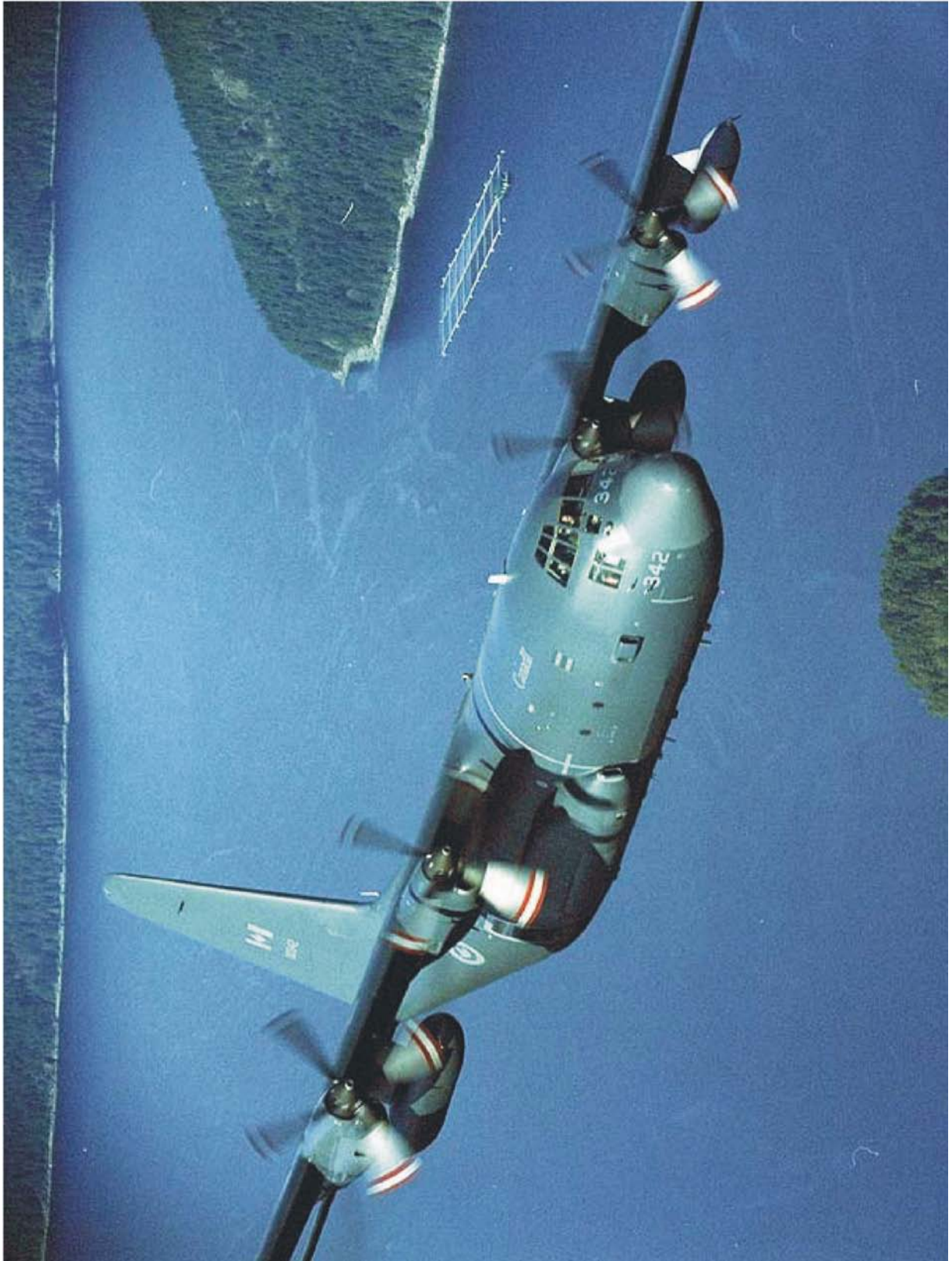

Figure 12B-3 Slide No. 3



Figure 12B-4 Slide No. 4

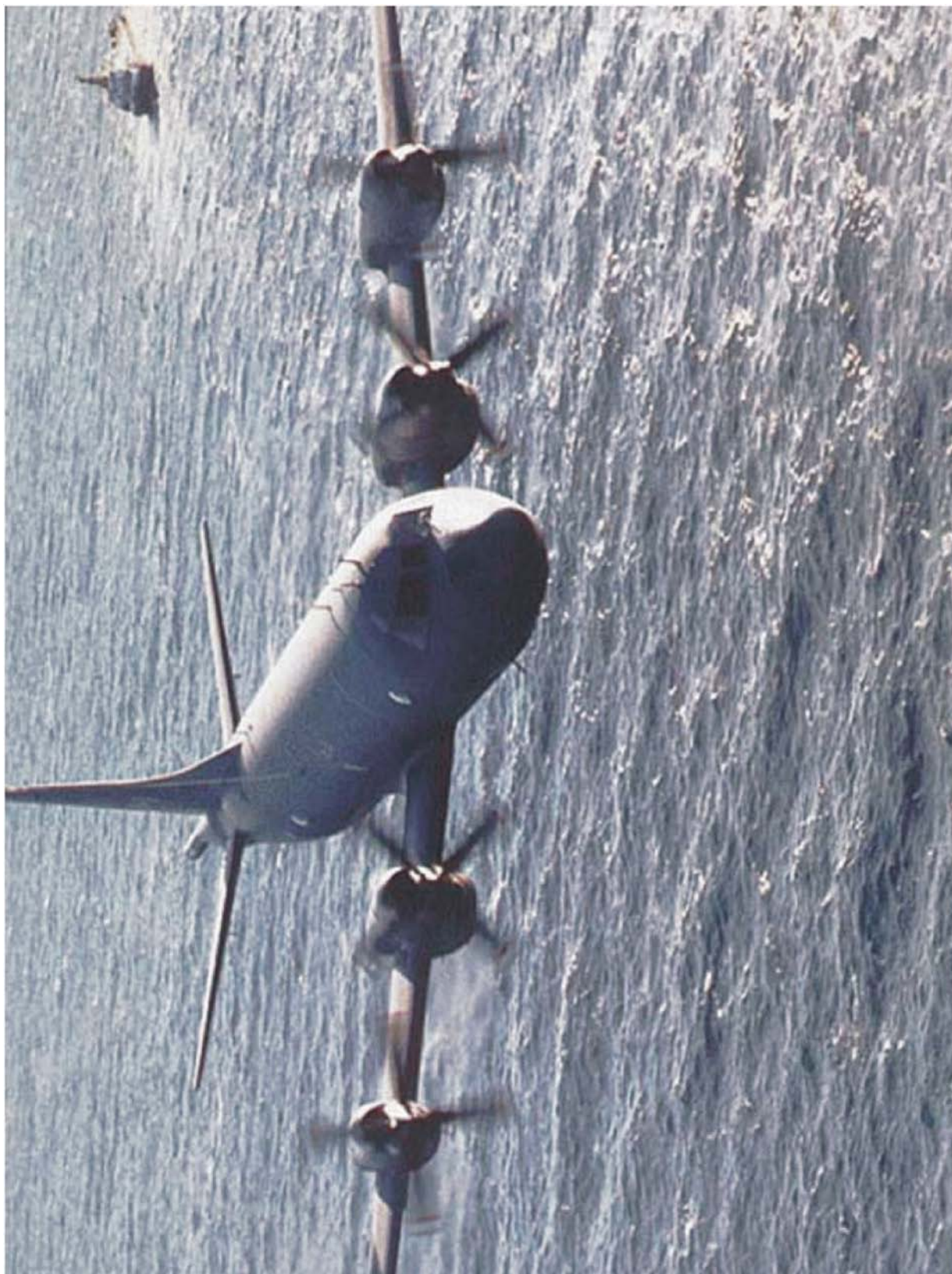

Figure 12B-5 Slide No. 5



Figure 12B-6 Slide No. 6



Figure 12B-7 Slide No. 7



Figure 12B-8 Slide No. 8



Figure 12B-9 Slide No. 9



Figure 12B-10 Slide No. 10



Figure 12B-11 Slide No. 11



Figure 12B-12 Slide No. 12



Figure 12B-13 Slide No. 13



Figure 12B-14 Slide No. 14



Figure 12B-15 Slide No. 15

THIS PAGE INTENTIONALLY LEFT BLANK

MAIN COMPONENTS OF AN AIRPLANE PUZZLE

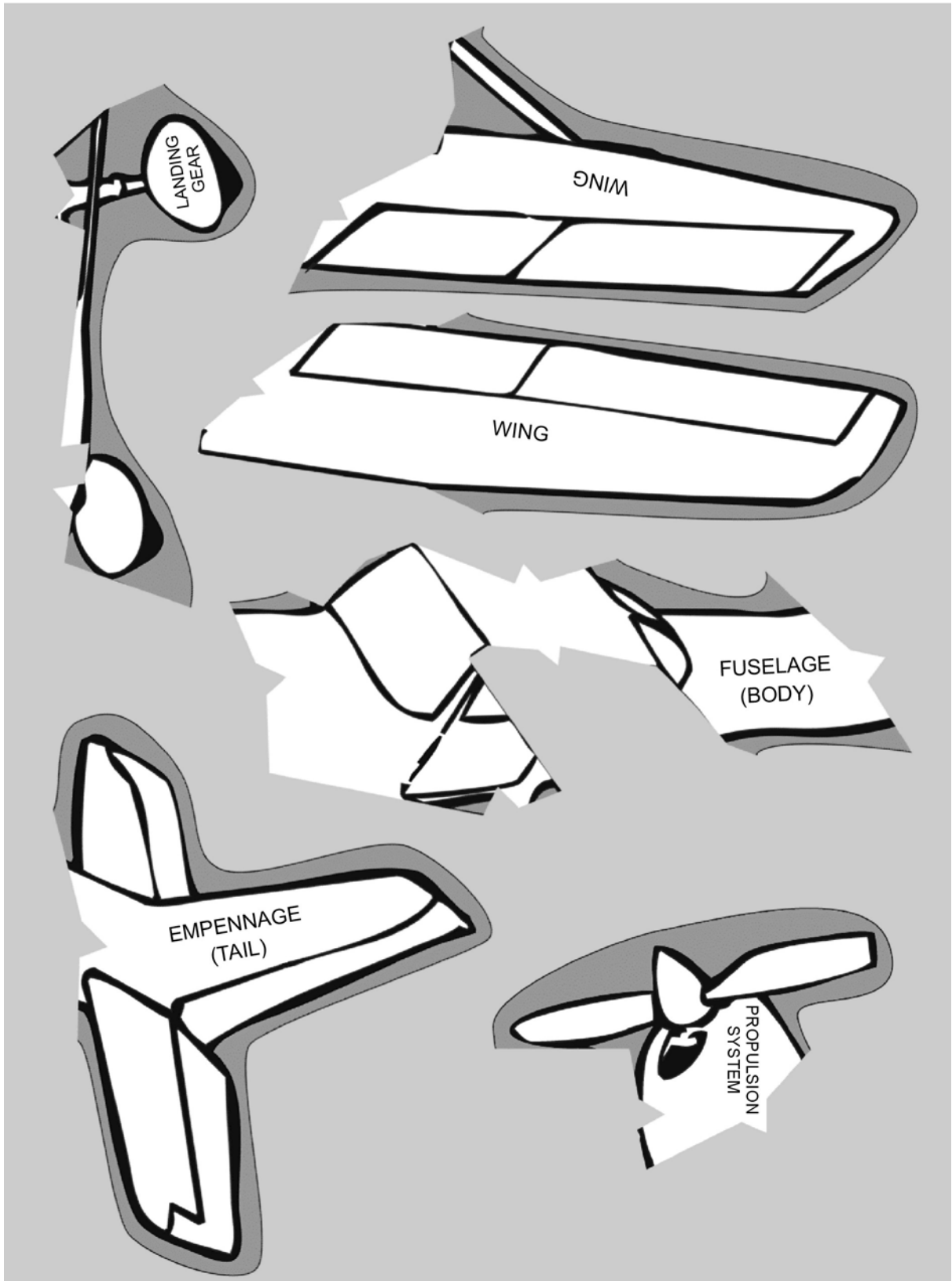

THIS PAGE INTENTIONALLY LEFT BLANK

FUSELAGE AND WING PUZZLE

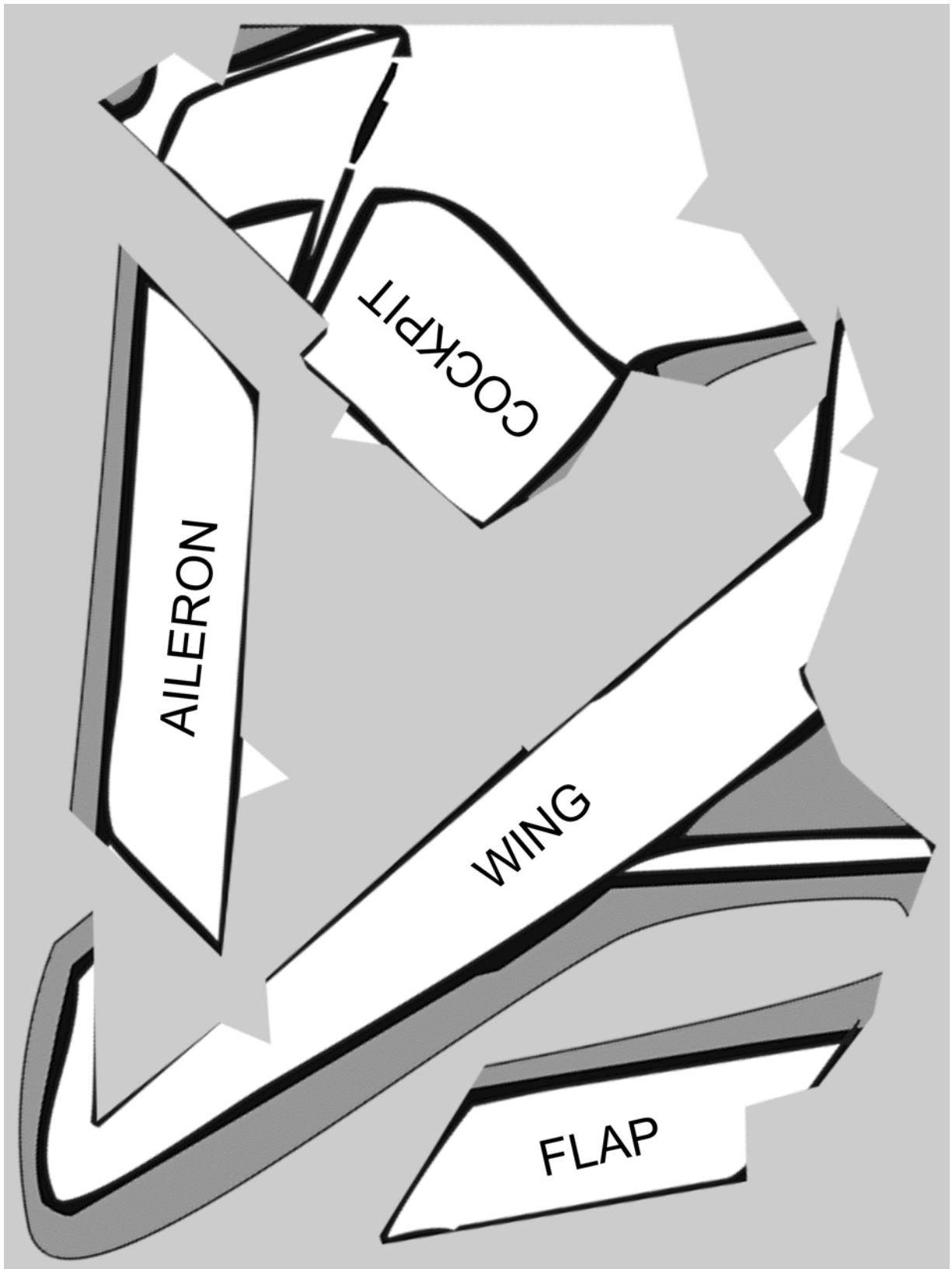

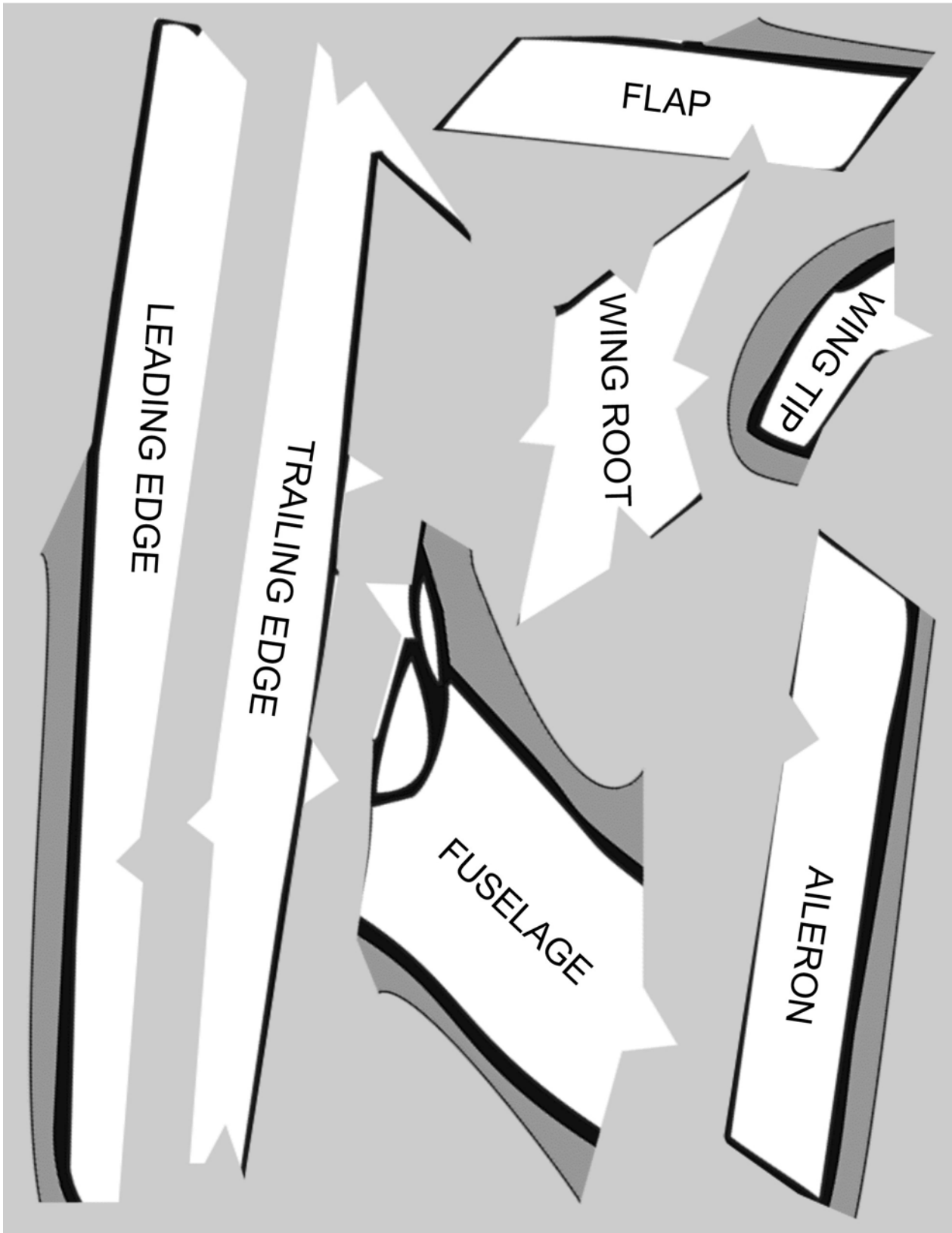

EMPENNAGE PUZZLE

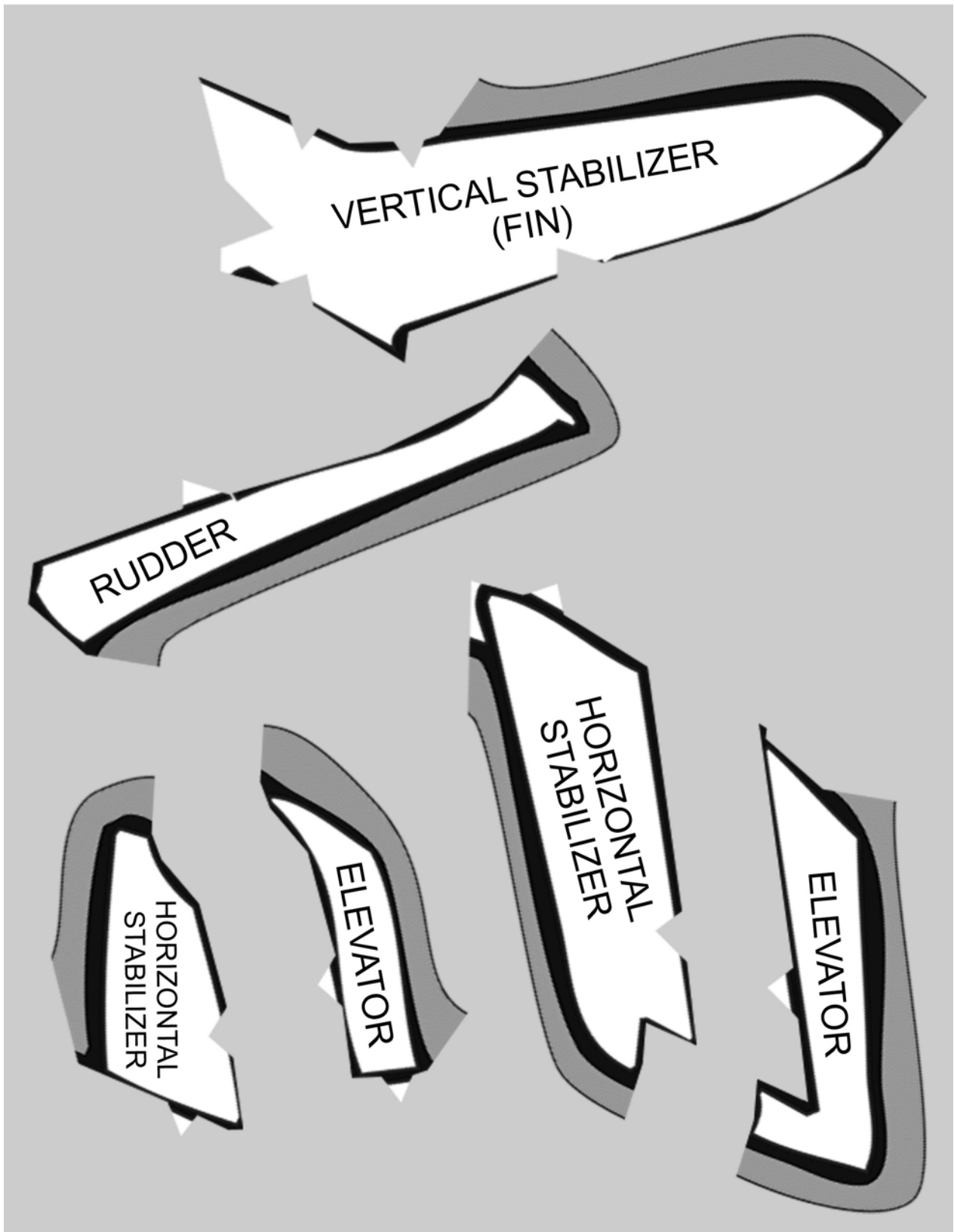

THIS PAGE INTENTIONALLY LEFT BLANK

LANDING GEAR AND PROPULSION SYSTEM PUZZLE

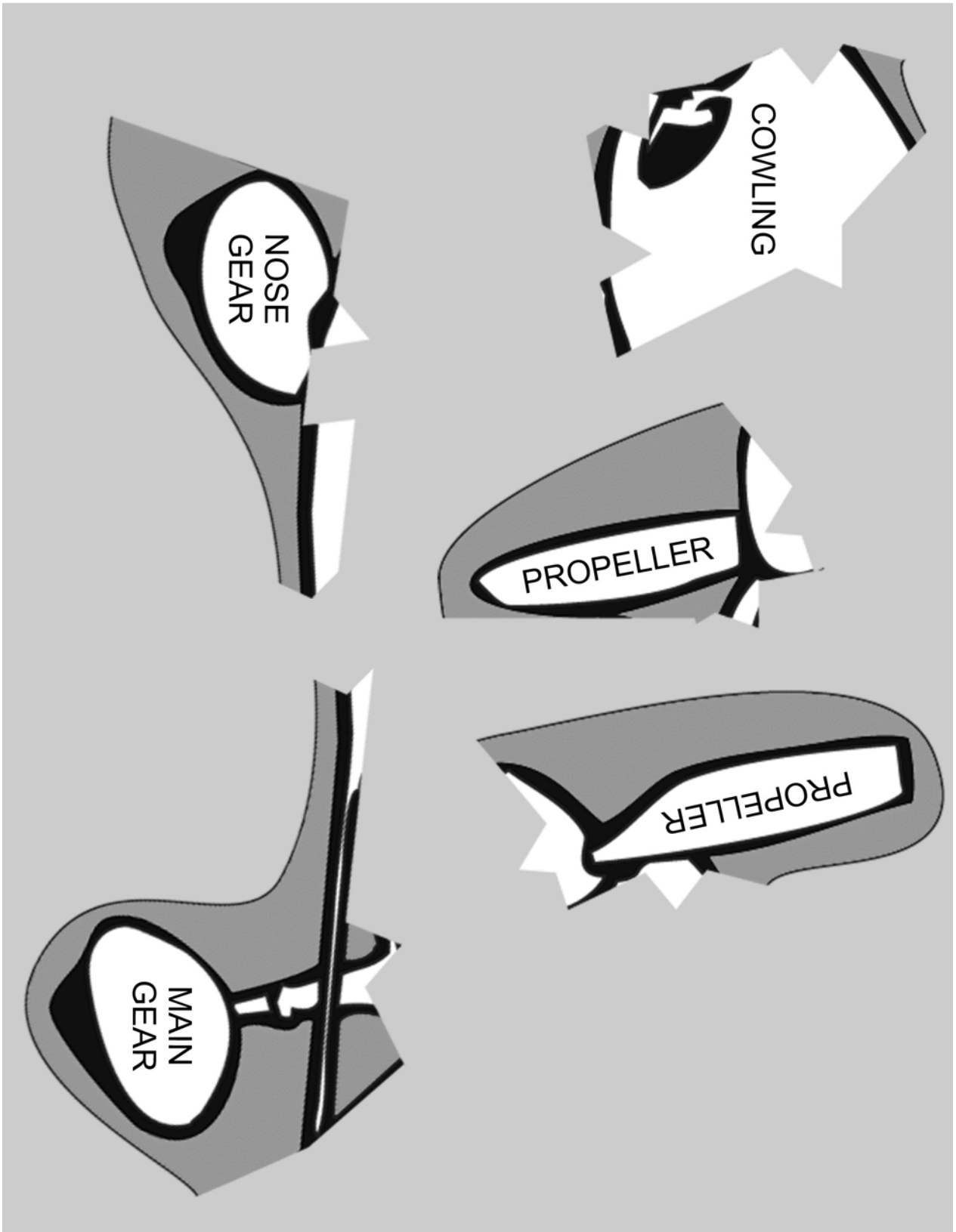

THIS PAGE INTENTIONALLY LEFT BLANK

PAPER MODEL ASSEMBLY INSTRUCTIONS

1. Cut out all the airplane pieces. Be careful not to mix your pieces with others.

2. Glue pieces 1F through 7R and 7L to build-up fuselage layers, carefully aligning parts. Ensure that the entire contacting surface of a smaller piece being fastened to a larger one is completely covered with glue.

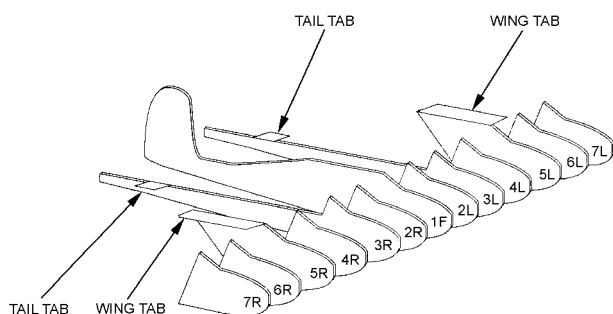

Figure 12G-1 Fuselage Assembly

3. To assemble the wings, glue 9M to the bottom of wing part 8W. Then glue 10B to the bottom of 9M. Make sure the wing parts are aligned along the centre line. Fold down the wing tabs on the fuselage, and apply glue to them. Fasten the wing assembly to the fuselage.

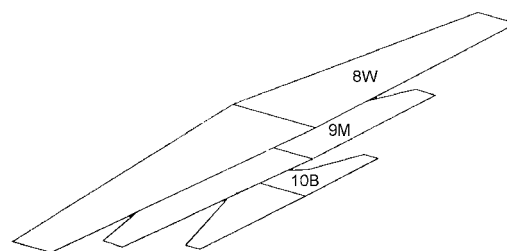

Figure 12G-2 Wing Assembly

4. To assemble the tail, fold down the tail tabs on the fuselage, and apply glue to them. Fasten the horizontal stabilizer 11S to the fuselage.

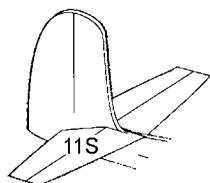

Figure 12G-3 Tail Assembly

5. To attach the propeller, pierce the centre of 12P with the thumbtack, and push the thumbtack into the centre of the fuselage assembly.

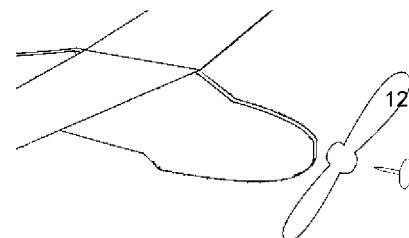

Figure 12G-4 Propeller Assembly

6. To attach the landing gear, clip the binder clip to the bottom of the fuselage, underneath the wings.

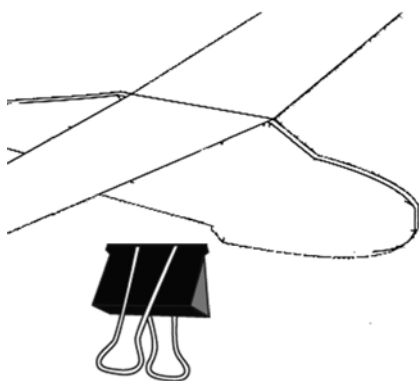

Figure 12G-5 Landing Gear Assembly

7. Color the model as desired.

Instructions and diagrams adapted from Fabulous Paper Gliders.

THIS PAGE INTENTIONALLY LEFT BLANK

PAPER MODEL AIRPLANE PARTS

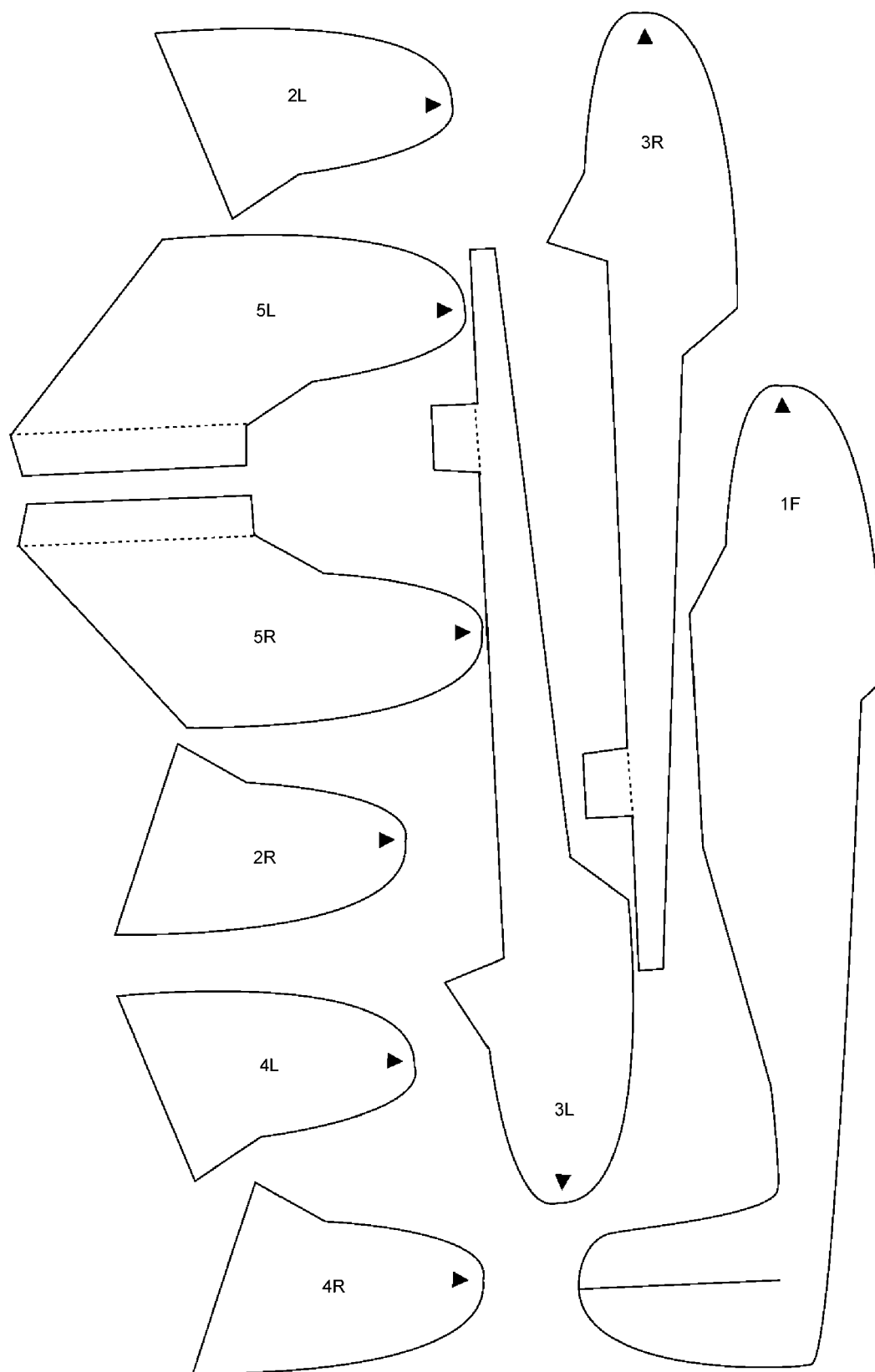

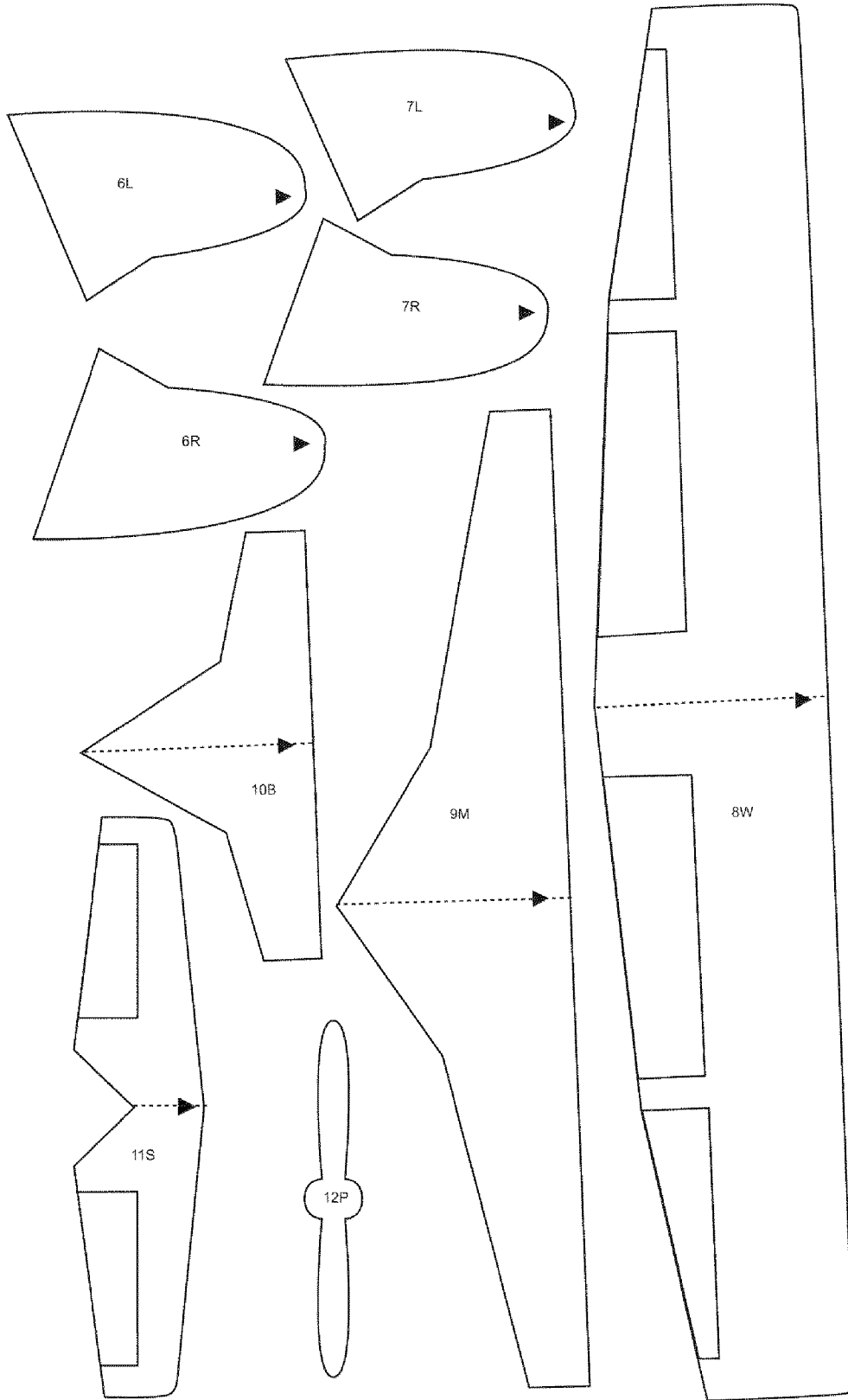

AMERICAN, BRITISH AND RUSSIAN AIRCRAFT PICTURES

















CHAPTER 13

PO 140 – PARTICIPATE IN AEROSPACE ACTIVITIES



ROYAL CANADIAN AIR CADETS

LEVEL ONE

INSTRUCTIONAL GUIDE



SECTION 1

EO M140.01 – BUILD AND LAUNCH A MODEL ROCKET

Total Time:

90 min

INTRODUCTION

PRE-LESSON INSTRUCTIONS

A complete list of resources needed for the instruction of this EO is located at Chapter 2 of the QSP. Specific uses for said stores are identified throughout the Instructional Guide, within the teaching point for which they are required.

Prior to instructing this lesson the instructor shall:

- review the lesson content, and become familiar with the material;
- create model rockets at various stages of completion for demonstration purposes;
- inform the cadets they will not be in uniform for this EO;
- ensure the following materials are collected for cadet use (per pair) during the lesson:
 - heavy paper (60 to 110 index stock) or construction paper;
 - plastic 35 mm film canisters with internal sealing lids;
 - photocopies of reference as described in Annexes A and B;
 - transparent tape;
 - scissors;
 - effervescent antacid tablets;
 - paper towels;
 - water;
 - eye protectors; and
 - markers and pencil crayons.

PRE-LESSON ASSIGNMENT

N/A.

APPROACH

The interactive lecture method was chosen as it allows the instructor to make a semi-formal presentation of the material where the cadets can participate by asking or responding to questions and commenting on the

material. For this lesson, this method is most effective as it matches well the taxonomic level of the material and is age-appropriate by virtue of its participatory nature.

The demonstration and performance methods were chosen due to the practical nature of the subject matter. These methods provide the instructor the opportunity to introduce the subject matter, demonstrate procedures and observe the cadets practicing and performing the skill. The demonstration and performance methods must always be used when the taxonomic level of the material requires a performance of a skill. These methods are highly developmentally appropriate for young cadets.

REVIEW

N/A.

OBJECTIVES

By the end of this lesson the cadet shall be expected to:

- identify important moments in space history;
- build a model rocket; and
- launch a model rocket.

IMPORTANCE

In the last century there have been a number of developments that have allowed mankind to explore beyond the atmosphere of the Earth. Aerospace is an important industry in Canada, which employs over 80 000 Canadians. This industry has demonstrated excellence in areas such as satellite, communication and robotics technologies. Through the introduction of satellites, there have been significant advancements made to make global communication and observation much more efficient. None of this would be possible without the introduction of rockets to the world of science.

Teaching Point 1

Discuss Important Events in Space History

Time: 15 min

Method: Interactive Lecture

THE FIRST ROCKETS

Prior to 1900, rockets were mainly used as weapons or fireworks. In 1898 a Russian school teacher proposed the idea of space exploration through the use of rockets. On 4 October 1957, the Soviet Union launched the satellite Sputnik I, the first successful use of a space-going rocket. The United States followed in January of 1958, launching their satellite with the use of a rocket.

MANNED SPACE MISSIONS

The United States became the first and only country to land on the moon when Neil Armstrong set foot on the moon in 1969. Marc Garneau was the first Canadian astronaut, sent to space in 1984. In 1992, Canada sent its first woman into space, Roberta Bondar.

FURTHER SPACE EXPLORATION

Manned space missions continue today, focusing on both orbital missions as well as missions to the International Space Station. Satellites continue to be used for space exploration, but have also found a role in a number of other areas, including radio and television, as well as Earth observation through weather monitoring. Navigation systems have also improved from satellites such as global positioning systems. Landers have also been used in recent history, most notable the recent Mars Exploration Rover Missions in 2003. Commercial space travel has also gained interest in the last few years, with civilians paying substantial amounts of money

for an opportunity to travel into both sub-orbit and orbit. All of these aspects of space exploration depend on rocket technologies in order for them to be successful.



The instructor should research this field before teaching the class, and is encouraged to include any related current events, because information is continually changing.

CONFIRMATION OF TEACHING POINT 1

QUESTIONS

- Q1. What was the name of the satellite launched by the first successful space-going rocket? When was it launched?
- Q2. Who was the first Canadian astronaut in space?
- Q3. What are some uses for satellites?

ANTICIPATED ANSWERS

- A1. Sputnik I, 4 October 1957.
- A2. Marc Garneau.
- A3. Surveillance, exploration, and communication (e.g. satellite television and radio).

Teaching Point 2

Build a Model Rocket

Time: 45 min

Method: Demonstration and Performance

ACTIVITY – BUILD A MODEL ROCKET

Time: 45 min

OBJECTIVE

The objective of this activity is to build a model rocket, which will foster interest in rocketry and familiarize the cadets with basic rocket components.

RESOURCES

- Heavy paper (60 to 110 index stock) or construction paper.
- Plastic 35 mm film canisters with internal sealing lids.
- Photocopies of reference as described in Annexes A and B.
- Transparent tape.
- Scissors.
- Markers and pencil crayons.
- Model rockets (completed at various stages).

ACTIVITY LAYOUT

The instructor will:

1. divide the class into pairs;
2. show the model rocket to the cadets so they understand what the finished project should look like;
3. ensure each pair has been issued with materials including heavy paper, a film canister, tape, and scissors (extra materials should be given out if the cadets make mistakes); and
4. demonstrate each step of construction, showing an example of a rocket at that stage, and then having the cadets complete that step.

SAFETY

N/A.

INSTRUCTOR GUIDELINES

- Prior to the lesson, read the general instructions on pages 43 to 46 of the reference, *Rockets: A Teacher's Guide with Activities in Science, Mathematics, and Technology*. Copies of the general instructions for this activity are included as Annexes A and B. The instructions for rocket construction and launching are also included in the Interactive Handbook for the cadets' reference.
- Encourage the groups to think about the design of their rocket before cutting the heavy paper. Inform the cadets they may design the rockets as they wish, remembering that the design will affect its performance.
- Encourage the cadets to draw and colour designs on the paper prior to the construction of the rocket.

Teaching Point 3

Launch a Model Rocket

Time: 20 min

Method: Demonstration and Performance

ACTIVITY – LAUNCH A MODEL ROCKET

Time: 25 min

OBJECTIVE

The objective of this activity is to launch a model rocket, which will foster interest in rocketry and familiarize the cadets with the fundamentals of rocket propulsion.

RESOURCES

- Effervescent (antacid) tablets.
- Paper towels.
- Water.
- Eye protectors.
- Model rockets.

ACTIVITY LAYOUT

- Once the rockets are complete, move the class outside to an area suitable for launching rockets.

- The instructor will put on eye protection, demonstrate the launching process (see Instructor Guidelines) and answer any questions the cadets may have.
- The groups will then be given their effervescing tablet, water and eye protection.
- Cadets will then launch the rockets one at a time, with assistance from the instructor as required.

SAFETY

The instructor will ensure that all cadets wear eye protection during launching of the rockets and ensure that the rockets are being launched in a suitable location.

INSTRUCTOR GUIDELINES

- The launching process is as follows (see instructions in Annex B for more details):
 1. turn the rocket upside down and fill the canister 1/3 full with water;
 2. drop in 1/2 of an effervescing tablet;
 3. swirl the mixture quickly;
 4. place lid on;
 5. set rocket down on launch platform (flat surface), and
 6. stand back.
- The instructor may give prizes for the highest vertical distance, or furthest distance, as well as for the best constructed or decorated rocket.

END OF LESSON CONFIRMATION

To confirm cadets' comprehension of the material, pose the following questions to the class as reflection questions:

- Q1. What causes the rocket to lift-off?
- Q2. What forces are acting on the rocket?
- Q3. How does the design of the rocket affect how high it will fly?
- A1. The rocket lifts off because it is acted upon by an unbalanced force (Newton's first law of motion).
- A2. The forces that are acting on the rocket are gravity (drag) and the force of thrust caused by the combination of water with the effervescing tablet.
- A3. Slim rockets are less resistant to forces such as drag than wider rockets. The smoother (more aerodynamic) the surface of the rocket is, also reduces the amount of drag acting on the rocket.

CONCLUSION

HOMEWORK/READING/PRACTICE

N/A.

METHOD OF EVALUATION

This EO will not be formally assessed.

CLOSING STATEMENT

The amount of research that has gone into aerospace over the past century has been very extensive. Advancements in technology have been able to take items such as rockets, satellites, and probes to scientific heights once unheard. These advancements have allowed mankind to explore the solar system in a greater depth, as well as increased the communication and observation abilities throughout Earth. Rockets play a fundamental part in making all of this possible.

INSTRUCTOR NOTES/REMARKS

N/A.

REFERENCES

- C3-016 (EG-2003-01-108-HQ) NASA. (2003). *Rockets: A Teacher's Guide With Activities in Science, Mathematics, and Technology*. Washington, DC: NASA.
- C3-036 Canadian Space Agency. (2006). *Canada's Astronauts*. Retrieved 26 April 2006, from www.space.gc.ca/asc/eng/astronauts/bio.asp.
- C3-037 Canadian Space Agency. (2006). *Space Exploration*. Retrieved 26 April 2006, from www.space.gc.ca/asc/eng/exploration/exploration.asp.



ROYAL CANADIAN AIR CADETS

LEVEL ONE

INSTRUCTIONAL GUIDE



SECTION 2

EO C140.01 – PARTICIPATE IN AN ACTIVITY ABOUT CANADIAN ASTRONAUTS

Total Time:	30 min
-------------	--------

INTRODUCTION

PRE-LESSON INSTRUCTIONS

A complete list of resources needed for the instruction of this EO is located at Chapter 2 of the QSP. Specific uses for said stores are identified throughout the Instructional Guide, within the teaching point for which they are required.

Prior to instructing this lesson the instructor shall:

- review the lesson content, and become familiar with the material;
- set up the classroom into four stations; and
- copy Annexes C to G and ensure there are enough copies for the stations.

PRE-LESSON ASSIGNMENT

N/A.

APPROACH

The small group activity was selected to allow for maximum participation in the learning process. It is an interactive way to illustrate and substantiate the lesson material in a concrete manner.

The group discussion method was chosen to allow the cadets to share their knowledge, opinions, and feelings about the subject matter while still allowing the instructor to control the direction of the discussion. The instructor must ensure that points not brought forth by the class are presented. If the instructor follows the Instructional Guide, including the questions posed, this will allow the cadets to express, in their own words, what they learned from this lesson and how they may apply the information.

REVIEW

N/A.

OBJECTIVES

By the end of this lesson the cadet shall be expected to participate in a discussion on Canadian astronauts.

IMPORTANCE

Being introduced to Canadian astronauts will promote an interest in aerospace. Discussing these astronauts will give the cadets a broader understanding of how Canadians are involved in space exploration.

BACKGROUND KNOWLEDGE

MARC GARNEAU

Education

- Received a Bachelor of Science degree in Engineering Physics from the Royal Military College of Kingston in 1970.
- Received a Doctorate in Electrical Engineering from the Imperial College of Science and Technology, London, England in 1973.
- Attended the Canadian Forces Command and Staff College of Toronto from 1982 to 1983.

Awards

- Companion of the Order of Canada.
- Named Chancellor of Carleton University in 2003.
- Awarded a Doctor of Science degree, *honoris causa* by York University in 2002 and the University of Lethbridge in 2001.
- Prix Montfort en sciences in 2003.
- Golden Jubilee Medal in 2002.
- NASA Exceptional Service Medal in 1997.
- NASA Space Flight Medals in 1984, 1996 and 2000.
- Canadian Decoration (military) in 1980.
- Athlone Fellowship in 1970.
- National Research Council Bursary in 1972.
- Honorary Doctorates by the University of Ottawa in 1997, the College militaire royal de Saint-Jean in 1990, the Universite Laval, Quebec in 1985, the Technical University of Nova Scotia in 1985 and the Royal Military College, Kingston, Ontario in 1985.
- Co-recipient of the F.W. (Casey) Baldwin Award in 1985 for the best paper in the *Canadian Aeronautics and Space Journal*.

Missions and Highlights

- **STS-41G**
 - The shuttle for this mission was the Challenger and was launched on 5 October 1984 at 7:03:00 a.m. EDT from Kennedy Space Center.
 - It landed back on earth on 13 October 1984 at 12:26:38 p.m. EDT at Kennedy Space Center.
 - The mission lasted for 8 days, 5 hours, 23 minutes, 38 seconds.
 - During the mission the shuttle orbited 133 times and traveled 5.47 million kilometres.
 - On this mission, Marc Garneau became the first Canadian to go into space. This was the first time NASA ever sent a seven-person crew into space.

- **STS-77**

- The shuttle for this mission was the Endeavour and was launched on 19 May 1996 at 6:30:00 a.m. from Kennedy Space Center.
- It landed back on earth on 29 May 1996 at 7:09:18 a.m. EST at Kennedy Space Center.
- The mission lasted for 10 days, 0 hours, 39 minutes, 18 seconds.
- During the mission, the shuttle orbited 161 times and traveled 6.60 million kilometres.
- Marc Garneau became the first Canadian to make a return trip to space. The SPACEHAB-4 laboratory module, housed in the shuttle's cargo bay, was used to conduct microgravity research in many different fields of study. Marc Garneau manoeuvred the Canadarm during the retrieval of the Spartan 207 satellite.

- **STS-97**

- The shuttle for this mission was the Endeavour and was launched on 20 November 2000 at 10:06:00 p.m. EST from Kennedy Space Center.
- It landed back on earth on December 11, 2000 at 6:04:20 PM EST at Kennedy Space Center.
- The mission lasted for 10 days, 19 hours, 58 minutes, 20 seconds.
- During the mission, the shuttle orbited 171 times and traveled 7.20 million kilometres.
- Marc Garneau became the first Canadian astronaut to make a third journey into space. This mission was the sixth construction flight for the International Space Station (ISS) and the primary goal was to attach the P6 truss, which included the first pair of large solar power arrays for the space station. He used the Canadarm to remove the P6 truss from the payload bay and then he positioned it in place while two "space walking" American astronauts attached it to the ISS.

ROBERTA BONDAR

Education

- Received a Bachelor of Science in zoology and agriculture from the University of Guelph in 1968.
- Received a Masters of Science in experimental pathology from the University of Western Ontario in 1971.
- Received a Ph.D. in neurobiology from the University of Toronto in 1974.
- Received a M.D. from McMaster University in 1977.
- Admitted as a Fellow of the Royal College of Physicians and Surgeons of Canada as a specialist in neurology in 1981.

Awards

- Officer of the Order of Canada.
- Canada 125 Medal.
- NASA's Space Medal.
- Hubertus Strunghold Award.
- Space Medicine Branch.

- Aerospace Medicine Association.
- Award of Merit, University of Western Ontario.
- 1995 Women's Intercultural Network International Women's Day Award.
- 1993 Alumnus of the Year, University of Guelph.
- Outstanding Canadian, Armenian Community Centre of Toronto.
- YWCA Woman of Distinction Award, Prince Albert, Saskatchewan.
- Kurt Hahn Award, Outward Bound.
- 1992 Paul Harris Recognition Award.
- Rotary Club of Ancaster.
- Inductee into the Hamilton Gallery of Distinction.

Missions and Highlights

- **STS-42**
 - The shuttle for this mission was the Discovery and was launched on 22 January 1992 at 9:52:33 a.m. EST from Kennedy Space Center.
 - It returned back to earth on 30 January 1992 at 8:07:17 a.m. PST at Edwards Air Force Base.
 - The mission lasted 8 days, 1 hour, 14 minutes, 44 seconds.
 - During the mission the shuttle orbited 129 times and traveled 4.70 million kilometres.
 - Roberta Bondar became the first Canadian woman to go into space. The International Microgravity Laboratory (IML) module was taken into space for the first time. The IML was carried in the cargo bay and was connected by a tunnel to the shuttle's middeck. It was used to explore in depth the complex effects of weightlessness on living organisms.

CHRIS HADFIELD

Education

- Received a Bachelor Degree in Mechanical Engineering (with honours), Royal Military College, Kingston Ontario in 1982.
- Conducted post-graduate research at the University of Waterloo, Ontario in 1982.
- Received a Master of Science in Aviation Systems at the University of Tennessee in 1992.

Awards

- Recipient of the 1988 Liethen-Tittle Award (top pilot graduate of the USAF Test Pilot School).
- U.S. Navy Test Pilot of the Year Award in 1991.
- Honorary Doctorate of Engineering from the Royal Military College in 1996.
- Member of the Order of Ontario in 1996.
- Honorary Doctorate of Laws from Trent University in 1999.

- Vanier Award in 2001.
- Meritorious Service Cross in 2001.
- NASA Exceptional Service Medal in 2002.
- Queen's Golden Jubilee Medal in 2003.
- Inducted into Canada's Aviation Hall of Fame in 2005.

Missions and Highlights

- **STS-74**
 - The shuttle for this mission was the Atlantis and was launched on 12 November 1995 at 7:30:43 a.m. EST from Kennedy Space Center.
 - It returned to earth on 20 November 1995 at 12:01:27 p.m. EST at Kennedy Space Center.
 - The mission lasted 8 days, 4 hours, 31 minutes, 42 seconds.
 - During the mission the shuttle orbited 129 times and traveled 5.5 million kilometres.
- **STS-100**
 - The shuttle for this mission was the Endeavour and was launched on 19 April 2001 at 2:41:42 p.m. EDT from Kennedy Space Center.
 - It returned to earth on 1 May 2001 at 9:11:42 p.m. PDT at Edwards Air Force Base.
 - The mission lasted 11 days, 21 hours, 30 minutes, 0 seconds.
 - During the mission the shuttle orbited 187 times and traveled 7.9 million kilometres.

JULIE PAYETTE

Education

- Received an International Baccalaureate in 1982 at the World International College of the Atlantic in South Wales, UK.
- Received a Bachelor of Electrical Engineering in 1986 from McGill University.
- Received a Master of Applied Science – Community Engineering in 1990 from the University of Toronto.

Awards

- Received one of six available Canadian scholarships to attend the International UWC of the Atlantic in South Wales, UK in 1980.
- Greville-Smith Scholarship in 1982 to 1986.
- Highest undergraduate award at McGill University.
- McGill Faculty Scholar in 1983 to 1986.
- NSERC post-graduate Scholarship from 1988 to 1990.
- Massey College Fellowship from 1988 to 1990.

- Canadian Council of Professional Engineers awarded her its 1994 distinction for exceptional achievement by a young engineer.
- National Order of Quebec.

Missions and Highlights

- **STS-96**
 - The shuttle for this mission was the Discovery and was launched on 27 May 1999 at 6:49:42 a.m. EST from Kennedy Space Center.
 - It returned to earth on 6 June 1999 at 2:02:43 a.m. EDT at Kennedy Space Center.
 - The mission lasted 9 days, 19 hours, 13 minutes, 57 seconds.

ACTIVITY

Time: 15 min

OBJECTIVE

The objective of this activity is for the cadets to discuss and present their findings about several Canadian astronauts.

RESOURCES

- Astronaut information found in Annexes C through F.
- Questions found in Annex G.
- Flipchart paper.
- Flipchart markers.

ACTIVITY LAYOUT

- Set-up the classroom with four stations (one per astronaut). If the class is big, more stations with overlapping astronauts are acceptable.
- Each station should have the information for the astronaut (found in the Annexes C through F), a set of questions to answer (found in Annex G) and flipchart paper and markers.
- Divide the class into four groups (or more if the class is big).
- Assign each group to a station.
- At the stations, the groups are to read the information (a reader or readers can be selected at the station) and write the answers to the questions provided at the station on the flipchart paper.

SAFETY

N/A.

INSTRUCTOR GUIDELINES



At this point the instructor shall brief the cadets on any safety rules or any other guidelines pertaining the activity.

- Supervise to ensure all cadets are participating.
- Gather the groups together after 10 minutes for the presentations.
- Ensure the cadets have presented all of the information for their astronaut.

REFLECTION

Time: 10 min

Method: Group Discussion

GROUP DISCUSSION

At this point, each group will present their astronaut to the class.



Instructor shall ensure that all lesson objectives are drawn out towards the end of the reflection stage.

DISCUSSION QUESTIONS



TIPS FOR ANSWERING/FACILITATING DISCUSSION

- Ask questions that help facilitate discussion; in other words, avoid questions with yes or no answers.
- Prepare questions ahead of time.
- Be flexible (you are not bound to only the prepared questions).
- Encourage cadets to participate by using praise such as “great idea” or “excellent response, can anyone add to that?”.
- Try to involve everyone by directing questions to non-participants.

SUGGESTED QUESTIONS

Q1. What did you find interesting about this class?



Other questions and answers will develop throughout the reflection stage. The discussion should not be limited to only those suggested.

CONCLUSION

REVIEW

Upon completion of the group discussion, conclude by summarizing the discussion to ensure that all teaching points have been covered. Take the opportunity to explain how the cadet will apply this knowledge in the future.

MAIN TEACHING POINTS

TP1. Marc Garneau.

TP2. Roberta Bondar.

TP3. Chris Hadfield.

TP4. Julie Payette.



Instructors shall reinforce those answers and comments discussed during reflection, but must ensure that the main teaching points have been covered. Any main teaching point not brought out during the group discussion shall be inserted during review.

HOMEWORK/READING/PRACTICE

N/A.

METHOD OF EVALUATION

There is no formal assessment of this EO.

CLOSING STATEMENT

Canadian astronauts are active in space exploration. Discussing them will encourage the cadets to research other astronauts and have an understanding of how they are involved in space exploration.

INSTRUCTOR NOTES/REMARKS

N/A.

REFERENCES

C3-028 Big Sky Astronomical Society. (2006). Retrieved 27 April 2006, from <http://www.bigsky.ab.ca/education.htm>.

C3-029 National Aeronautics and Space Administration. (1997-2006). Retrieved 27 April 2006, from <http://www.jsc.nasa.gov/bios/index.html>.

MODEL ROCKET

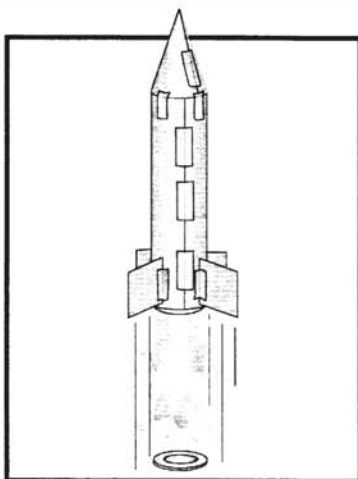

Teacher Information

3-2-1 POP!

Objective:

To demonstrate how rocket liftoff is an application of Newton's Laws of Motion.

Description:

Students construct a rocket powered by the pressure generated from an effervescent antacid tablet reacting with water.

Science Standards:

Physical Science - Position and motion of objects
Science and Technology - Abilities of technological design - Understanding about science and technology

Process Skills:

Observing
Communicating
Making Models
Inferring

Management:

For best results, students should work in pairs. It will take approximately 40 to 45 minutes to complete the activity. Make samples of rockets in various stages of completion available for students to study. This will help some students visualize the construction steps.

A single sheet of paper is sufficient to make a rocket. Be sure to tell the students to plan how they are going to use the paper. Let the students decide whether to cut the paper the short or long direction to make the body tube of the rocket. This will lead to rockets of different lengths for flight comparison.

The most common mistakes in constructing the rocket are: forgetting to tape the film canister to the rocket body, failing to mount the canister with the lid end down, and not extending the canister far enough from the paper tube to make snapping the lid easy. Some students may have difficulty in forming the cone. To make a cone, cut out a "Pacman" shape from a circle and curl it into a cone. See the pattern on the next page. Cones can be any size.

Materials and Tools:

- Heavy paper (60-110 index stock or construction paper)
 - Plastic 35 mm film canister*
 - Student sheets
 - Cellophane tape
 - Scissors
 - Effervescent antacid tablet
 - Paper towels
 - Water
 - Eye protection
- * The film canister must have an internal-sealing lid. See management section for more details.



ROCKETEER NAMES

COUNTDOWN:

1. Put on your eye protection.
2. Turn the rocket upside down and fill the canister one-third full of water.

Work quickly on the next steps!

3. Drop in 1/2 tablet.
4. Snap lid on tight.
5. Stand rocket on launch platform.
6. Stand back.

LIFTOFF!

What three ways can you improve your rocket?

1. _____
2. _____
3. _____

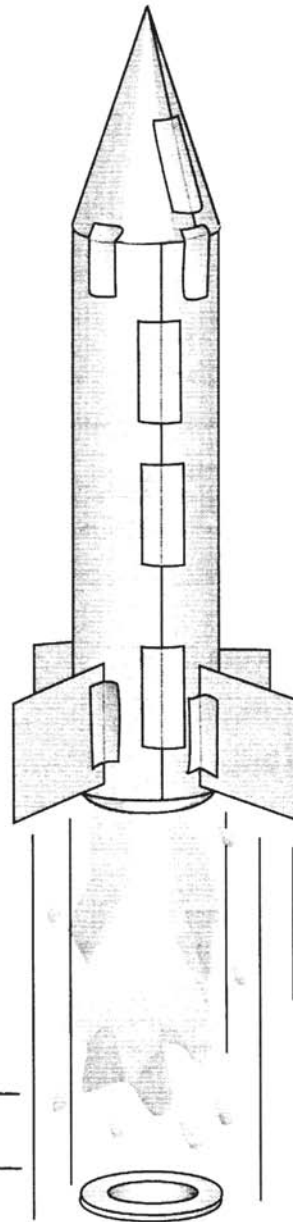

MODEL ROCKET – LAUNCHING PROCESS

3-2-1 POP!

1

Wrap and tape a tube of paper around the film canister. The lid end of the canister goes down!

2

3

Lid

Tape fins to your rocket.

4

Ready for flight

5

Cone Pattern

Overlap this edge to form cone

Cones can be any size!

Tape

Roll a cone of paper and tape it to the rocket's upper end.



Rockets: A Teacher's Guide with Activities in Science, Mathematics, and Technology

EG-108 February 1996

5

Film canisters are available from camera shops and stores where photographic processing takes place. These businesses recycle the canisters and are often willing to donate them for educational use. Be sure to obtain canisters with the internal sealing lid. These are usually translucent canisters. Canisters with the external lid (lid that wraps around the canister rim) will not work. These are usually opaque canisters.

Background Information:

This activity is a simple but exciting demonstration of Newton's Laws of Motion. The rocket lifts off because it is acted upon by an unbalanced force (First Law). This is the force produced when the lid blows off by the gas formed in the canister. The rocket travels upward with a force that is equal and opposite to the downward force propelling the water, gas, and lid (Third Law). The amount of force is directly proportional to the mass of water and gas expelled from the canister and how fast it accelerates (Second Law). For a more complete discussion of Newton's Laws of Motion, see pages 13-17 in this guide.

Procedure:

Refer to the Student Sheet.

Discussion:

- How does the amount of water placed in the cylinder affect how high the rocket will fly?
- How does the temperature of the water affect how high the rocket will fly?
- How does the amount of the tablet used affect how high the rocket will fly?
- How does the length or empty weight of the rocket affect how high the rocket will fly?
- How would it be possible to create a two-stage rocket?

Assessment:

Ask students to explain how Newton's Laws of Motion apply to this rocket. Compare the rockets for skill in construction. Rockets that use excessive paper and tape are likely to be less efficient fliers because they carry additional weight.

Extensions:

- Hold an altitude contest to see which rockets fly the highest. Launch the rockets near a wall in a room with a high ceiling. Tape a tape measure to the wall. Stand back and observe how high the rockets travel upward along the wall. Let all students take turns measuring rocket altitudes
- What geometric shapes are present in a rocket?
- Use the discussion questions to design experiments with the rockets. Graph your results.



BIOGRAPHICAL DATA – MARC GARNEAU



National Aeronautics and Space Administration
Lyndon B. Johnson Space Center
Houston, Texas 77058



BIOGRAPHICAL DATA

MARC GARNEAU (PH.D.)

ASTRONAUT, CANADIAN SPACE AGENCY (FORMER)

Born in February 1949 in Quebec City, Canada. He received his early education in Quebec City and Saint-Jean-sur-Richelieu in Quebec and in London, England. He received a Bachelor of Science degree in Engineering Physics from the Royal Military College of Kingston in 1970, and a Doctorate in Electrical Engineering from the Imperial College of Science and Technology, London, England, in 1973. He attended the Canadian Forces Command and Staff College of Toronto in 1982 to 1983.

Marc Garneau was a Combat Systems Engineer in HMCS Algonquin from 1974 to 1976. While serving as an instructor in naval weapon systems at the Canadian Forces Fleet School in Halifax, 1976 to 1977, he designed a simulator for use in training weapons officers in the use of missile systems aboard Tribal class destroyers. He served as Project Engineer in naval weapon systems in Ottawa from 1977 to 1980. He returned to Halifax with the Naval Engineering Unit, which troubleshoots and performs trials on ship-fitted equipment, and helped develop an aircraft-towed target system for the scoring of naval gunnery accuracy. Promoted to Commander in 1982 while at Staff College, he was transferred to Ottawa in 1983 and became design authority for naval communications and electronic warfare equipment and systems. In January 1986, he was promoted to Captain. He retired from the Navy in 1989. He is one of six Canadian astronauts selected in December 1983. He was seconded to the Canadian Astronaut Program from the Department of National Defence in February 1984 to begin astronaut training. He became the first Canadian astronaut to fly in space as a Payload Specialist on Shuttle Mission 41-G in October 1984. He was named Deputy Director of the Canadian Astronaut Program in 1989, providing technical and program support in the preparation of experiments to fly during future Canadian missions. He was selected for Mission Specialist training in July 1992.

Marc Garneau reported to the Johnson Space Center in August 1992. He completed a one-year training and evaluation program to be qualified for flight assignment as a Mission Specialist. He initially worked on technical issues for the Astronaut Office Robotics Integration Team and subsequently served as Capsule Communicator (CAPCOM) in Mission Control during Shuttle flights. A veteran of three space flights (STS-41G in 1984, STS-77 in 1996 and STS-97 in 2000), Marc Garneau has logged over 677 hours in space.

In February 2001, Marc Garneau was appointed Executive Vice President, Canadian Space Agency. He was subsequently appointed President of the Canadian Space Agency, effective 22 November 2001.

Honorary Fellow of the Canadian Aeronautics and Space Institute. Member of the Association of Professional Engineers of Nova Scotia, and the Navy League of Canada. He was named Honorary Member of the Canadian Society of Aviation Medicine in 1988 and a Member of the International Academy of Astronautics in 2002. Marc Garneau is the National Honorary Patron of Hope Air and Project North Star and the President of the Board of the McGill Chamber Orchestra.

He was promoted Companion of the Order of Canada in 2003, having been appointed as an Officer in 1984. Named Chancellor of Carleton University (2003). Awarded a Doctor of Science degree, *honoris causa*, by York University (2002) and the University of Lethbridge (2001). Recipient of the Prix Montfort en sciences (2003); Golden Jubilee Medal of Her Majesty Queen Elizabeth II (2002); NASA Exceptional Service Medal (1997); NASA Space Flight Medals (1984, 1996, 2000); the Canadian Decoration (military) (1980); the Athlone Fellowship (1970); and the National Research Council (NRC) Bursary (1972). Awarded Honorary Doctorates by the University of Ottawa (1997); the College militaire royal de Saint-Jean (1990); the Universite Laval, Quebec (1985); the Technical University of Nova Scotia (1985); and the Royal Military College, Kingston, Ontario (1985). Co-recipient of the F.W. (Casey) Baldwin Award in 1985 for the best paper in the Canadian Aeronautics and Space Journal.

June 2004

MARC GARNEAU



IMAGE CREDIT: NASA

Marc Garneau was born in Quebec City on 23 February 1949. In 1970, he received a Bachelor of Science degree in Engineering Physics from the Royal Military College in Kingston, Ontario. In 1973, he received a Doctorate (Ph.D.) in Electrical Engineering from the Imperial College of Science and Technology in London, England.

In 1983, he was selected as one of the original six Canadian astronauts and in 1984 he became the first Canadian in space. Marc Garneau is a veteran of three space shuttle flights and has logged over 677 hours in space. His first trip into space was aboard the Space Shuttle Challenger, while his next two journeys into space were aboard the Space Shuttle Endeavour.

Doctor Garneau was appointed an Officer of the Order of Canada in 1984 and is currently the President of the Canadian Space Agency.



Mission: STS-41G

Space Shuttle: Challenger

Commander: Robert Crippen

Pilot: Jon McBride

Mission Specialists: Kathryn Sullivan, Sally Ride, David Leestma

Payload Specialists: Marc Garneau, Paul Scully-Power

Launch Date: 5 October 1984

Launch Time: 7:03:00 a.m. EDT

Launch Site: Kennedy Space Center (KSC)

Launch Pad: 39A

Landing Date: 13 October 1984

Landing Time: 12:26:38 p.m. EDT

Landing Site: Kennedy Space Center (KSC)

Mission Duration: 8 days, 5 hours, 23 minutes, 38 seconds

Number of Orbits: 133 orbits

Distance Traveled: 5.47 million kilometres

Mission Highlights: Marc Garneau became the first Canadian to go into space. This was the first time NASA ever sent a seven-person crew into space. The Earth Radiation Budget Satellite (ERBS) was deployed. Scientific observations of the earth were conducted from the payload bay with the Office of Space and Terrestrial Applications (OSTA-3) pallet. An IMAX camera was taken along on this flight as was a package of Canadian Experiments (CANEX).



Mission: STS-77

Space Shuttle: Endeavour

Commander: John Casper

Pilot: Curtis Brown, Jr.

Mission Specialists: Daniel Bursch, Mario Runco, Jr., Marc Garneau, Andrew Thomas

Launch Date: 19 May 1996
Launch Time: 6:30:00 a.m. EST
Launch Site: Kennedy Space Center (KSC)
Launch Pad: 39B
Landing Date: 29 May 1996
Landing Time: 7:09:18 a.m. EST
Landing Site: Kennedy Space Center (KSC)
Mission Duration: 10 days, 0 hours, 39 minutes, 18 seconds
Number of Orbits: 161
Distance Traveled: 6.60 million kilometres
Mission Highlights: Marc Garneau became the first Canadian to make a return trip to space. The SPACEHAB-4 laboratory module, housed in the shuttle's cargo bay, was used to conduct microgravity research in many different fields of study. The Commercial Float Zone Furnace (CFZF), one of the SPACEHAB-4 experiments, was used to produce high-quality crystals that could be used to manufacture products such as computer chips, lasers, and infrared detectors. The Inflatable Antenna Experiment (IAE) was inflated to its full size (approximately 15 meters in diameter) and its performance was documented for later analysis. Afterwards, the IAE was jettisoned. The IAE was attached to the Spartan-207 satellite, which was deployed and retrieved with the Remote Manipulator System (Canadarm). Marc Garneau manoeuvred the Canadarm during the retrieval of this satellite.



Mission: STS-97
Space Shuttle: Endeavour
Commander: Brent Jett
Pilot: Michael Bloomfield
Mission Specialists: Joseph Tanner, Marc Garneau, Carlos Noriega
Launch Date: 30 November 2000
Launch Time: 10:06:00 p.m. EST
Launch Site: Kennedy Space Center (KSC)
Launch Pad: 39B
Landing Date: 11 December 2000

Landing Time: 6:04:20 p.m. EST

Landing Site: Kennedy Space Center (KSC)

Mission Duration: 10 days, 19 hours, 58 minutes, 20 seconds

Number of Orbits: 171

Distance Traveled: 7.20 million kilometres

Mission Highlights: Marc Garneau became the first Canadian Astronaut to make a third journey into space. This mission was the sixth construction flight for the International Space Station (ISS) and the primary goal was to attach the P6 truss, which included the first pair of large solar power arrays for the space station. Marc Garneau used the Remote Manipulator System (Canadarm) to remove the P6 truss from the payload bay and then he positioned it in place while two "space walking" American Astronauts attached it to the ISS. While docked with the ISS, the crew of the Space Shuttle Endeavour and the ISS Expedition One Crew transferred equipment and supplies from the shuttle to the space station. They also transferred refuse from the space station to the shuttle so that it could be returned to Earth and disposed of properly.



In Toronto, there is a high school named in honour of Dr. Marc Garneau. The school formerly known as Overlea Secondary School was renamed Marc Garneau Collegiate Institute on 16 October 1987.

BIOGRAPHICAL DATA – ROBERTA LYNN BONDAR



National Aeronautics and Space Administration

Lyndon B. Johnson Space Center

Houston, Texas 77058



BIOGRAPHICAL DATA

ROBERTA LYNN BONDAR, O.C., O.ONT., M.D., PH.D., F.R.C.P.©

ASTRONAUT, CANADIAN SPACE AGENCY (FORMER)

Personal Data. Born in Sault Ste. Marie, Ontario, Canada. Dr. Bondar has certification in scuba diving, parachuting, and holds a private pilot's license. She enjoys photography, biking, hot air ballooning, roller blading, and flying.

Current Status. Distinguished Professor, Centre for Advanced Technology Education (CATE), Ryerson Polytechnic University, Toronto, Ontario; CIBC Distinguished Professor, Faculty of Kinesiology, University of Western Ontario, London, Ontario; Visiting Research Scholar, Department of Neurology, University of New Mexico; Visiting Research Scientist, Universities Space Research Association, Johnson Space Centre, Houston, Texas.

Current Activities. Principal investigator, Transcranial Doppler in Patients with Orthostatic Intolerance, University of New Mexico, Deaconess Hospital, Boston; Principal investigator, Transcranial Doppler in Astronauts Before and After Space Flight, Johnson Space Centre, Edwards Air Force Base, and Kennedy Space Centre; Author, *Touching the Earth*, Key Porter Books, Toronto, Ontario; Chair, Friends of the Environment Foundation (non-profit organization of Canada Trust).

Education. Attended elementary and secondary school in Sault Ste. Marie, Ontario. Degrees: B.Sc. in zoology and agriculture, University of Guelph, 1968, M. Sc. in experimental pathology, University of Western Ontario, 1971, Ph.D. in neurobiology, University of Toronto, 1974, M.D., McMaster University, 1977. Admitted as a Fellow of the Royal College of Physicians and Surgeons of Canada as a specialist in neurology in 1981.

Experience. Dr. Bondar is a neurologist and researcher. After internship in internal medicine at Toronto General Hospital, she completed post-graduate medical training in neurology at the University of Western Ontario; neuro-ophthalmology at Tuft's New England Medical Center (Boston) and the Playfair Neuroscience Unit of Toronto Western Hospital; and carotid Doppler ultrasound and transcranial Doppler at the Pacific Vascular Institute (Seattle). She was appointed Assistant Professor of Medicine (Neurology), McMaster University, 1982 to 1984; Scientific staff, Sunnybrook Medical Centre, Toronto, 1988 to present; Visiting Research Scholar, Department of Neurology, University of New Mexico, 1993 to 1995; Adjunct Professor, Department of Biology, University of New Mexico, 1992 to 1994; Distinguished Professor, CATE, Ryerson, 1992 to present; Visiting Distinguished Fellow, Department of Medicine, Faculty of Health Sciences, McMaster University, 1993 to 1994; Visiting Distinguished Professor, Faculty of Kinesiology, University of Western Ontario, 1994 to present.

She was one of the six original Canadian astronauts selected in December, 1983 and began astronaut training in February, 1984. She served as chairperson of the Canadian Life Sciences Subcommittee for Space Station from 1985 to 1989, and as a member of the Ontario Premier's Council on Science and Technology from 1988 to 1989. In early 1990, she was designated a prime Payload Specialist for the first International Microgravity Laboratory Mission (IML-1). Dr. Bondar flew on the space shuttle Discovery during Mission STS-42, 22 to

30 January 1992 where she performed life science and material science experiments in the Spacelab and on the middeck.

Dr. Roberta Bondar left the Canadian Space Agency effective 4 September 1992, to pursue her research.

Honorary Degrees. D.Sc., Mount Allison University, Sackville, New Brunswick, 1989; D.Hum.L., Mount St. Vincent University, Halifax, Nova Scotia, 1990; Senior Fellowship from Ryerson Polytechnical Institute, Toronto, Ontario, 1990; D.Sc., University of Guelph, Guelph, Ontario, 1990; D.Sc., Lakehead University, Thunder Bay, Ontario, 1991; D.Sc., Algoma College, Laurentian University, Sault Ste. Marie, Ontario, 1991; D.Sc., Saint Mary's University, Halifax, Nova Scotia, 1992; D.Sc., McMaster University, Hamilton, Ontario, 1992; L.L.D. University of Regina, Regina, Saskatchewan, 1992; L.L.D., University of Calgary, Calgary, Alberta; D.U., University of Ottawa, Ottawa, Ontario, 1992; D.Sc., University of Toronto, Toronto, Ontario, 1992; D.Sc., McGill University, Montreal, Quebec, 1992; D.Sc., York University, Toronto, Ontario, 1992; D.Sc., Carleton University, Ottawa, Ontario, 1993; D.S.L., Wycliffe College, University of Toronto, Toronto, Ontario, 1993; D.Sc., Royal Roads Military College, Victoria, British Columbia, 1993; D.Sc., Memorial University, St. John's, Newfoundland, 1993; D.Sc., Laval University, Laval, Quebec, 1993; D.Sc., University of Montreal, Montreal, Quebec, 1994; D.Sc., University of Prince Edward Island, Charlottetown, Prince Edward Island, 1994; D.Sc., University of Western Ontario, London, Ontario, 1995.

Special Honors and Awards. Officer of the Order of Canada; the Order of Ontario; Canada 125 Medal; NASA's Space Medal; Hubertus Strughold Award, Space Medicine Branch, Aerospace Medicine Association; Award of Merit, University of Western Ontario; Medaille de L'Excellence, L'Association des Medecins de Langue Francaise du Canada; La Personnalite de L'Annee 1992, La Presse; 1995 Women's Intercultural Network International Women's Day Award; 1993 Alumnus of the Year, University of Guelph; Outstanding Canadian, Armenian Community Centre of Toronto; YWCA Woman of Distinction Award, Prince Albert, Saskatchewan, Kurt Hahn Award, Outward Bound; 1992 Paul Harris Recognition Award, Rotary Club of Ancaster, Inductee into the Hamilton Gallery of Distinction. Honorary Life Member, Canadian Federation of University Women, Girl Guides of Canada, Federation of Medical Women of Canada, Science North, and Zonta International.

Honorary Appointments. Patron, World Congress of Neurology (Vancouver), Canadian Federation of Business and Professional Women's Clubs, Mission Air Transportation Network, Canadian Bushplane Heritage Centre, Young Scientists of Canada, Aphasia Centre (North York), Ontario Parks Association, Earth Observation Theatre - Fort Whyte Centre (Winnipeg); 1995 International Mathematical Olympiad. Honorary Chairperson, Canadian Coalition for Quality Daily Physical Education, Women's Soccer Competition - World Student Games, The Parkinson Foundation of Canada, Marsville Program - Ontario Science Centre; Honorary Colonel, 22 Wing, Canadian Armed Forces, Hornell Heights, Ontario; Honorary Director, Save Our North Atlantic Resources; Member, Canadian Association for Women in Science, l'Association des Medecins de Langue Francaise du Canada; Bootmakers of Canada, Canadian Aviation Historical Society.

Honors in Name of Roberta Lynn Bondar. Roberta Bondar Public School, Ottawa, Ontario; Dr. Roberta Bondar Public School, Ajax, Ontario; Queen Elizabeth Public School Resource Centre, Sault Ste. Marie; Alex Muir Public School Resource Centre, Sault Ste. Marie; Trophy for Outstanding Male and Female Athlete of the Year, Sir James Dunn Collegiate and Vocational School, Sault Ste. Marie; Roberta Bondar Gymnasium, Sir James Dunn Collegiate and Vocational School, Sault Ste. Marie; Soo College Scholarship, Sault Ste. Marie; Sir James Dunn Collegiate and Vocational School Scholarship, Sault Ste. Marie; Bawating Collegiate and Vocational School Scholarship, Sault Ste. Marie; Girl Guides of Canada Scholarship; Province of Ontario Science and Technology Awards, USS Bondar, The Guelph Trek Club; Roberta Bondar Earth and Space Centre, Seneca College, Toronto, Ontario; Place Roberta Bondar - Province of Ontario, Sault Ste. Marie; YWCA Scholarship, Prince Albert, Saskatchewan; Roberta Bondar Rose, Hortico Nurseries; Roberta Bondar Park and Tent Pavilion, Sault Ste. Marie, Ontario.

Organizations. Fellow, Royal College of Physicians and Surgeons of Canada, Member, American Academy of Neurology, Canadian Aeronautics and Space Institute, Canadian Society of Aerospace Medicine, College of Physicians and Surgeons of Ontario, Canadian Stroke Society, Aerospace Medical Association, Albuquerque Aerostat Ascension Association, American Society for Gravitational and Space Biology, Association for Space

Explorers, Canadian Society of Aerospace Medicine, Greater Albuquerque Medical Association, Canadian Medical Association, Ontario Medical Association, Canadian Association of Sports Medicine.

July 1997

ROBERTA BONDAR



IMAGE CREDIT: NASA

Roberta Bondar was born in Sault Ste. Marie on 4 December 1945. She received a Bachelor of Science degree in zoology and agriculture from the University of Guelph in 1968, a Master of Science degree in Experimental Pathology from the University of Western Ontario in 1971, a doctorate (Ph.D.) in Neurobiology from the University of Toronto in 1974, and a Doctor of Medicine degree from McMaster University in 1977.

In 1983, she was selected as one of the original six Canadian astronauts and in 1992, aboard the Space Shuttle Discovery, Doctor Bondar became the first neurologist in space and also the first Canadian woman in space. Roberta Bondar, the second Canadian astronaut in space, retired from the astronaut corps shortly after returning from her journey into space because she wanted to devote more time to her research.

Doctor Bondar is an Officer of the Order of Canada and has been elected to the Canadian Medical Hall of Fame for her pioneering space medical research.



- Mission:** STS-42
- Space Shuttle:** Discovery
- Commander:** Ronald Grabe
- Pilot:** Stephen Oswald
- Mission Specialists:** Norman Thagard, William Readdy, David Hilmers
- Payload Specialists:** Roberta Bondar, Ulf Merbold
- Launch Date:** 22 January 1992
- Launch Time:** 9:52:33 a.m. EST
- Launch Site:** Kennedy Space Center (KSC)
- Launch Pad:** 39A
- Landing Date:** 30 January 1992
- Landing Time:** 8:07:17 a.m. PST
- Landing Site:** Edwards Air Force Base
- Mission Duration:** 8 days, 1 hour, 14 minutes, 44 seconds
- Number of Orbits:** 129
- Distance Traveled:** 4.70 million kilometres
- Mission Highlights:** Roberta Bondar became the first Canadian woman to go into space. The International Microgravity Laboratory (IML) module was taken into space for the first time. The IML was carried in the cargo bay and was connected by a tunnel to the shuttle's middeck. It was used to explore in depth the complex effects of weightlessness on living organisms. The international crew was divided into two teams for around-the-clock research on the human nervous system's adaptation to low gravity and the effects of microgravity on other life forms such as shrimp eggs, fruit fly eggs, lentil seedlings, and bacteria. An IMAX camera was taken along on this flight.
- DID YOU KNOW?** In Toronto, there is a planetarium named in honour of Dr. Roberta Bondar. the Roberta Bondar Earth and Space Centre Planetarium is located at Seneca College (Newnham Campus).

THIS PAGE INTENTIONALLY LEFT BLANK

BIOGRAPHICAL DATA – CHRIS A. HADFIELD



National Aeronautics and Space Administration
Lyndon B. Johnson Space Center
Houston, Texas 77058



BIOGRAPHICAL DATA

CHRIS A. HADFIELD (COLONEL, CAF, RET.)

ASTRONAUT, CANADIAN SPACE AGENCY

Personal Data. Born 29 August 1959, in Sarnia, and raised in Milton, Ontario, Chris Hadfield is married to Helene Hadfield (Walter). They have three children. He enjoys skiing, playing guitar, singing, riding, writing, running, and playing volleyball and squash. His parents, Roger and Eleanor Hadfield, reside near Milton. Her mother, Gwendoline Walter, resides in Victoria, B.C. Her father, Erhard Walter, is deceased.

Education. Graduated as an Ontario Scholar from Milton District High School in 1977; Received a Bachelor Degree in Mechanical Engineering (with honours), Royal Military College, Kingston, Ontario, Canada, in 1982; Conducted post-graduate research at the University of Waterloo, Ontario in 1982; Received a Master of Science in Aviation Systems at the University of Tennessee in 1992.

Affiliations. Royal Military College Club; Society of Experimental Test Pilots; Canadian Aeronautics and Space Institute, Honourary Patron of Lambton College; Trustee of Lakefield College School.

Special Honors. Recipient of the 1988 Liethen-Tittle Award (top pilot graduate of the USAF Test Pilot School); U.S. Navy Test Pilot of the Year (1991); Honorary Doctorate of Engineering from the Royal Military College (1996); Member of the Order of Ontario (1996); Honorary Doctorate of Laws from Trent University (1999); Vanier Award (2001); Meritorious Service Cross (2001); NASA Exceptional Service Medal (2002); Queen's Golden Jubilee Medal (2003); Inducted into Canada's Aviation Hall of Fame (2005).

Experience. Raised on a corn farm in southern Ontario, Chris Hadfield became interested in flying from a young age. As an Air Cadet, he won a glider pilot scholarship at age 15 and a powered pilot scholarship at age 16. He also taught skiing and ski racing part and full-time for 10 years.

Hadfield graduated as an Ontario scholar from Milton District High in 1977 and joined the Canadian Armed Forces in May 1978. He spent two years at Royal Roads Military College, in Victoria, British Columbia, followed by two years at the Royal Military College in Kingston, Ontario, where he received a Bachelor's Degree in Mechanical Engineering (with honors) in 1982. Hadfield underwent basic flight training in Portage La Prairie, Manitoba, for which he was named top pilot in 1980. In 1983, he took honors as the overall top graduate from Basic Jet Training in Moose Jaw, Saskatchewan, and in 1984 to 1985, he trained as a fighter pilot in Cold Lake, Alberta on CF-5s and CF-18s.

For the next three years Hadfield flew CF-18s for the North American Aerospace Defence Command (NORAD) with 425 Squadron, during which time he flew the first CF-18 intercept of a Soviet "Bear" aircraft. He attended the United States Air Force (USAF) Test Pilot School at Edwards Air Force Base, in California, and upon graduation, served as an exchange officer with the U.S. Navy at Strike Test Directorate at the Patuxent River Naval Air Station. His accomplishments from 1989 to 1992 include testing the F/A-18 and A-7 aircraft; performing research work with NASA on pitch control margin simulation and flight; completing the first military flight of

F/A-18 enhanced performance engines; piloting the first flight test of the National Aerospace Plane external burning hydrogen propulsion engine; developing a new handling qualities rating scale for high angle-of-attack test; and participating in the F/A-18 out-of-control recovery test program. In total, Hadfield has flown over 70 different types of aircraft.

In June 1992 Chris Hadfield was selected to become one of four new Canadian astronauts from a field of 5330 applicants. He was assigned by the Canadian Space Agency (CSA) to the NASA Johnson Space Center in Houston, Texas in August of the same year, where he addressed technical and safety issues for Shuttle Operations Development, contributed to the development of the glass shuttle cockpit, and supported shuttle launches at the Kennedy Space Center, in Florida. In addition, Hadfield was NASA's Chief CAPCOM, the voice of mission control to astronauts in orbit, for 25 space shuttle missions. From 1996 to 2000, he represented CSA astronauts and coordinated their activities as the Chief Astronaut for the Canadian Space Agency.

From 2001 to 2003, Hadfield was the Director of Operations for NASA at the Yuri Gagarin Cosmonaut Training Centre (GCTC) in Star City, Russia. His work included coordination and direction of all International Space Station crew activities in Russia, oversight of training and crew support staff, as well as policy negotiation with the Russian Space Program and other International Partners. He also trained and became fully qualified to be a flight engineer cosmonaut in the Soyuz TMA spacecraft, and to perform spacewalks in the Russian Orlan spacesuit.

Currently, Hadfield is a civilian CSA astronaut, having retired as a Colonel from the Canadian Air Force in 2003, after 25 years of military service. He is Chief of Robotics for the NASA Astronaut Office at the Johnson Space Center in Houston, Texas.

In November 1995 Hadfield served as Mission Specialist 1 on STS-74, NASA's second space shuttle mission to rendezvous and dock with the Russian Space Station Mir. During the flight, the crew of Space Shuttle Atlantis attached a five-tonne docking module to Mir and transferred over 1000 kg of food, water, and scientific supplies to the cosmonauts. Hadfield flew as the first Canadian mission specialist, the first Canadian to operate the Canada Arm in orbit, and the only Canadian to ever board Mir. The STS-74 Mission was accomplished in 8 days, 4 hours, 30 minutes and 44 seconds, during which time the shuttle traveled 5.5 million km, and orbited the earth 129 times.

In April 2001 Hadfield served as Mission Specialist 1 on STS-100, International Space Station (ISS) assembly Flight 6A. The crew of Space Shuttle Endeavour delivered and installed Canadaarm2, the new Canadian-built robotic arm, as well as the Italian-made resupply module Raffaello. During the flight, Hadfield performed two spacewalks, which made him the first Canadian to ever leave a spacecraft and float free in space. In total, Hadfield spent 14 hours, 54 minutes outside; 10 times around the world. The entire STS-100 Mission was accomplished in 11 days, 11 hours, and 30 minutes, during which time the shuttle traveled 7.9 million km, and orbited the earth 187 times.

January 2006

CHRIS HADFIELD



IMAGE CREDIT: NASA



Mission: STS-74
Space Shuttle: Atlantis
Commander: Kenneth Cameron
Pilot: James Halsell, Jr.
Mission Specialists: Jerry Ross, William McArthur Jr., Chris Hadfield
Launch Date: 12 November 1995
Launch Time: 7:30:43 a.m. EST
Launch Site: Kennedy Space Center (KSC)
Launch Pad: 39A
Landing Date: 20 November 1995
Landing Time: 12:01:27 p.m. EST
Landing Site: Kennedy Space Center (KSC)
Mission Duration: 8 days, 4 hours, 31 minutes, 42 seconds
Number of Orbits: 129
Distance Traveled: 5.5 million kilometres
Mission Highlights:



Mission: STS-100
Space Shuttle: Endeavour
Commander: Kent Rominger
Pilot: Jeffrey Ashby
Mission Specialists: Chris Hadfield, John Phillips, Scott Parazynski, Umberto Guidoni, Yuri Lonchakov
Launch Date: 19 April 2001
Launch Time: 2:41:42 p.m. EDT
Launch Site: Kennedy Space Center (KSC)

Launch Pad: 39A

Landing Date: 1 May 2001

Landing Time: 9:11:42 p.m. PDT

Landing Site: Edwards Air Force Base

Mission Duration: 11 days, 21 hours, 30 minutes, 0 seconds

Number of Orbits: 187

Distance Traveled: 7.9 million kilometres

Mission Highlights:

THIS PAGE INTENTIONALLY LEFT BLANK

BIOGRAPHICAL DATA – JULIE PAYETTE



National Aeronautics and Space Administration
Lyndon B. Johnson Space Center
Houston, Texas 77058

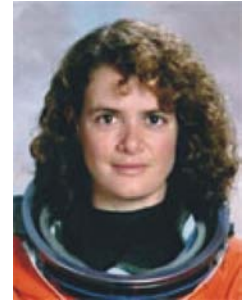

BIOGRAPHICAL DATA

JULIE PAYETTE

ASTRONAUT, CANADIAN SPACE AGENCY

Personal Data. Born 20 October 1963, in Montreal, Quebec. Enjoys running, skiing, racquet sports and scuba diving. Holds a multi-engine commercial pilot license with instrument and float ratings. Ms. Payette plays piano and has sung with the Montreal Symphonic Orchestra Chamber Choir, the Piacere Vocale in Basel, Switzerland, and with the Tafelmusik Baroque Orchestra Choir in Toronto, Canada. Fluent in French and English, and conversational in Spanish, Italian, Russian and German.

Education. Primary and secondary school in Montreal, Quebec. International Baccalaureate (1982) at the United World International College of the Atlantic in South Wales, UK. Bachelor of Electrical Engineering (1986) from McGill University, Montreal and a Master of Applied Science - Computer Engineering (1990) from the University of Toronto.

Organizations. Member of l'Ordre des Ingénieurs du Québec. Appointed member of the Natural Sciences and Engineering Research Council of Canada (NSERC). Fellow of the Canadian Academy of Engineering. Les Amies d'affaire du Ritz. Board of Director – Queen's University.

Special Honors. Received one of six available Canadian scholarships to attend the International UWC of the Atlantic in South Wales, UK (1980); Greville-Smith Scholarship (1982-1986); highest undergraduate award at McGill University; McGill Faculty Scholar (1983-1986); graduated with distinction in 1986. NSERC post-graduate Scholarship (1988-1990); Massey College Fellowship (1988-1990); Canadian Council of Professional Engineers 1994 (distinction for exceptional achievement by a young engineer). Chevalier de l'Ordre de la Pleiade de la francophonie; National Order of Quebec.

Honorary Degrees. Queen's University (1999); University of Ottawa (1999); Simon Fraser University (2000); Université Laval (2000); University of Regina (2001); Royal Roads University (2001); University of Toronto (2001); University of Victoria (2002); Nipissing University (2002); McGill University (2003); Mount Saint Vincent University (2004); McMaster University (2004), University of Lethbridge (2005), Mount Allison University (2005).

Experience. Before joining the Astronaut Corps, Ms. Payette conducted research in computer systems, natural language processing, automatic speech recognition and the application of interactive technologies to space. System engineer - IBM Canada (1986 to 1988). Research Assistant - University of Toronto (1988 to 1990). Visiting scientist – IBM Research Laboratory, Zurich, Switzerland (1991). Research engineer - Speech Research Group, Bell-Northern Research/Nortel, Montreal (1992).

Ms. Payette was selected by the Canadian Space Agency (CSA) as one of four astronauts amongst a field of 5330 applicants in June 1992. After undergoing basic training in Canada, she worked as a technical advisor for the MSS (Mobile Servicing System), an advanced robotics system and Canada's contribution to the International Space Station.

In preparation for a space assignment, Ms. Payette obtained her commercial pilot license, studied Russian and logged 120 hours as a research operator on board reduced gravity aircraft. In 1996, Ms. Payette was certified as a one-atmosphere deep sea diving suit operator and obtained her captaincy on the CT-114 military jet at the Canadian Air Force Base in Moose Jaw, Saskatchewan. Ms. Payette has logged more than 1100 hours of flight time.

NASA Experience. Ms. Payette reported to the NASA Johnson Space Center in Houston, Texas in August 1996. She completed initial astronaut training in April 1998 and was assigned to work technical issues in robotics for the Astronaut Office.

Julie Payette flew on Space Shuttle Discovery from 27 May to 6 June, 1999 as part of the crew of STS-96. During the mission, the crew performed the first manual docking of the Shuttle to the International Space Station (ISS), and delivered four tons of logistics and supplies to the Station. On Discovery, Ms. Payette served as a mission specialist, held responsibility for the Station systems and operated the Canadarm robotic arm on orbit. The STS-96 mission was accomplished in 153 orbits of the Earth, traveling 4 million miles in 9 days, 19 hours and 13 minutes. Ms. Payette became the first Canadian to participate in an ISS assembly mission and to board the Space Station.

Ms. Payette is the Chief Astronaut for the Canadian Space Agency. She also works as a CAPCOM (Capsule Communicator) at the Mission Control Center in Houston. She divides her time between these responsibilities and astronaut proficiency training.

February 2006

JULIE PAYETTE



IMAGE CREDIT: NASA



Mission: STS-96

Space Shuttle: Discovery

Commander: Kent Rominger

Pilot: Rick Husband

Mission Specialists: Ellen Ochoa, Tamara Jernigan, Daniel Barry, Julie Payette, and Valery Ivanovich Tokarev

Launch Date: 27 May 1999

Launch Time: 6:49:42 a.m. EDT

Launch Site: Kennedy Space Center (KSC)

Launch Pad: 39B

Landing Date: 6 June 1999

Landing Time: 2:02:43 a.m. EDT

Landing Site: Kennedy Space Center (KSC)

Mission Duration: 9 days, 19 hours, 13 minutes, 57 seconds

Number of Orbits:

Distance Traveled:

Mission Highlights:

QUESTIONS

Answer the following questions on the flipchart paper provided.

1. What is the name of the astronaut at this station?
2. What education does this astronaut have?
3. What awards has this astronaut received?
4. What missions has this astronaut been on? What were the highlights of the mission(s)?

Answer the following questions on the flipchart paper provided.

1. What is the name of the astronaut at this station?
2. What education does this astronaut have?
3. What awards has this astronaut received?
4. What missions has this astronaut been on? What were the highlights of the mission(s)?

Answer the following questions on the flipchart paper provided.

1. What is the name of the astronaut at this station?
2. What education does this astronaut have?
3. What awards has this astronaut received?
4. What missions has this astronaut been on? What were the highlights of the mission(s)?

Answer the following questions on the flipchart paper provided.

1. What is the name of the astronaut at this station?
2. What education does this astronaut have?
3. What awards has this astronaut received?
4. What missions has this astronaut been on? What were the highlights of the mission(s)?

Answer the following questions on the flipchart paper provided.

1. What is the name of the astronaut at this station?
2. What education does this astronaut have?
3. What awards has this astronaut received?
4. What missions has this astronaut been on? What were the highlights of the mission(s)?

THIS PAGE INTENTIONALLY LEFT BLANK

CHAPTER 14

PO 160 – PARTICIPATE IN AERODROME OPERATIONS ACTIVITIES



ROYAL CANADIAN AIR CADETS

LEVEL ONE

INSTRUCTIONAL GUIDE



SECTION 1

EO M160.01 – IDENTIFY MAJOR AERODROME COMPONENTS

Total Time:

30 min

INTRODUCTION

PRE-LESSON INSTRUCTIONS

The instructor shall review the lesson content and become familiar with the material prior to instruction of the lesson.

A complete list of resources needed for the instruction of this EO is located at Chapter 2 of the QSP. Specific uses for said stores are identified throughout the Instructional Guide, within the teaching point for which they are required.

PRE-LESSON ASSIGNMENT

N/A.

APPROACH

The interactive lecture method was chosen as it allows the instructor to make a semi-formal presentation of the material where the cadets can participate by asking or responding to questions and commenting on the material. For this lesson, this method is most effective as it matches well the taxonomic level of the material and is age-appropriate by virtue of its participatory nature.

REVIEW

N/A.

OBJECTIVES

By the end of this lesson the cadet shall be expected to identify the major components of an aerodrome, to include:

- runway;
- taxiway;
- apron;
- hangars;
- ramp areas;
- control towers;
- terminal buildings;

- wind socks;
- flying schools; and
- fire department.

IMPORTANCE

Knowing the various components of an aerodrome will assist cadets in identifying the components during aerodrome tours and familiarization flights. This information will also be useful in future lessons, including the activity associated with EO M160.03 (Section 3).

Teaching Point 1

Define the Terms Aerodrome and Airport

Time: 3 min

Method: Interactive Lecture



It is recommended that the instructor use the images of the various parts of the aerodrome found in Annex A, or refer the cadets to the images in their interactive handbooks, to supplement the other training aids they have prepared for this lesson.

AERODROME

Around the world there is an intricate system of aeronautical facilities designed to facilitate the efficient movement of air traffic. These many aerodromes vary widely in the facilities and the services they offer. However, there are certain standard features that apply to every aerodrome.

An aerodrome is any area of land or water designed for the arrival, departure and movement of aircraft (*From the Ground Up: Millennium Edition, 2000, p. 91*).

AIRPORT

An airport is a licensed aerodrome, which possesses a certificate stating it has met all airport safety standards (*From the Ground Up: Millennium Edition, 2000, p. 91*).

CONFIRMATION OF TEACHING POINT 1

QUESTIONS

- Q1. What is the definition of an aerodrome?
- Q2. What makes an airport different from an aerodrome?

ANTICIPATED ANSWERS

- A1. An aerodrome is any area of land or water, designed for the arrival, departure and movement of aircraft.
- A2. An airport possesses a certificate stating it has met all airport safety standards.

Teaching Point 2**Identify Aerodrome Components**

Time: 7 min

Method: Interactive Lecture

RUNWAY

The runway is the area where aircraft take-off and land. A runway may be made of pavement, grass, gravel, dirt or snow among other materials. Runways are identified by numbers and by the white lights that run along each side.

TAXIWAY

The taxiway is the area used by an aircraft to manoeuvre around the aerodrome between aprons and runways. Letters normally designate taxiways. At aerodromes with lighting, taxiways are defined by blue lights along each side.

APRON

The apron, also known as the tarmac or ramp area, is the part of an aerodrome intended to accommodate the loading and unloading of passengers and cargo. It is also the area used for refuelling, servicing and parking of aircraft.

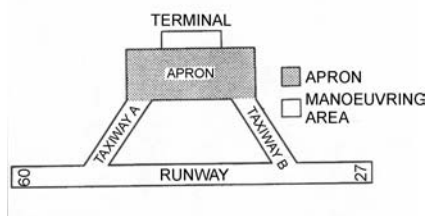

Royal Canadian Air Cadet Manual, Proficiency Level One Handbook, Cadets Canada, 1998

Figure 14-1-1 Aerodrome Movement Areas

HANGAR

The hangar is an aerodrome building that is used for storage, protection and maintenance of aircraft.

CONFIRMATION OF TEACHING POINT 2

QUESTIONS

- Q1. What types of material can a runway be made of?
- Q2. What is the purpose of a taxiway?
- Q3. What is the purpose of a hangar?

ANTICIPATED ANSWERS

- A1. Runways can be made of pavement, grass, gravel, dirt or snow.
- A2. The taxiway is the area used by an aircraft to move from the apron to the runway.
- A3. A hangar is an aerodrome building used to store, protect and maintain an aircraft.

Teaching Point 3**Identify Aerodrome Components**

Time: 7 min

Method: Interactive Lecture

CONTROL TOWER

Some aerodromes have the service of a control tower to ensure the safe and efficient movement of aircraft. The air traffic controllers in the tower are responsible for a number of procedures. These include take-off/landing procedures, circuit procedures and ground manoeuvring of aircraft.

TERMINAL BUILDINGS

Terminal buildings are used for passengers arriving and departing. They are also used for baggage and cargo handling. Terminal buildings are normally located on the apron.

WINDSOCK

All aerodromes have at least one windsock or wind t. The windsock is used by pilots to determine wind direction and speed. The approximate wind speed is indicated by the amount the windsock is extended. The wind t is designed like an arrow whose small end points into the wind. They are found on the airfield, normally beside the runway.

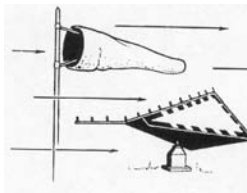

From the Ground Up : Millennium Edition, A.F. MacDonald, 2000

Figure 14-1-2 Windsock and Wind T

FLYING SCHOOLS

Flying schools are used as training facilities for current pilots and those that wish to pursue such a career.

CONFIRMATION OF TEACHING POINT 3

QUESTIONS

- Q1. What is the purpose of the control tower?
- Q2. What does a windsock indicate?
- Q3. What is the importance of flying schools?

ANTICIPATED ANSWERS

- A1. The purpose of the control tower is to provide the service of ensuring the safe and efficient movement of aircraft, through use of the air traffic controllers working within the tower.
- A2. A windsock indicates wind direction and speed.
- A3. Flying schools are used as training facilities for current pilots and those that wish to pursue such a career.

END OF LESSON CONFIRMATION

ACTIVITY

Time: 7 min

OBJECTIVE

The objective of this activity is to confirm that the cadets are able to correctly identify various components of an aerodrome.

RESOURCES

N/A.

ACTIVITY LAYOUT

- Divide cadets into groups of four to five.
- Have them complete the exercise in their interactive handbooks on page _____ by:
 - finding all of the aerodrome components embedded in the word search; and
 - match each aerodrome component found with the appropriate picture on the slides.
- After five minutes has passed, take two minutes to confirm the cadets' success with the exercise.

SAFETY

N/A.

INSTRUCTOR GUIDELINES

N/A.

CONCLUSION

HOMEWORK/READING/PRACTICE

N/A.

METHOD OF EVALUATION

There is no formal assessment of this EO. Instructors will confirm the cadets' comprehension of the material during the end of lesson check and when they construct a model aerodrome during the activity associated with EO M160.03 (Section 3).

CLOSING STATEMENT

The various areas of an aerodrome serve different purposes. As cadets, knowing the various components of an aerodrome will assist in identifying the components during tours and familiarization flights.

INSTRUCTOR NOTES/REMARKS

N/A.

REFERENCES

- A3-001 A-CR-CCP-263/PT-001, *From the Ground Up: Millennium Edition* (2000). Ottawa, ON: Aviation Publishers Co. Limited.
- C3-022 (ISBN 0-19-541731-3) *The Canadian Oxford Dictionary* (2001). Don Mills, ON: Oxford University Press.



ROYAL CANADIAN AIR CADETS

LEVEL ONE

INSTRUCTIONAL GUIDE



SECTION 2

EO M160.02 – IDENTIFY FEATURES OF A RUNWAY

Total Time:	30 min
-------------	--------

INTRODUCTION

PRE-LESSON INSTRUCTIONS

A complete list of resources needed for the instruction of this EO is located at Chapter 2 of the QSP. Specific uses for said stores are identified throughout the Instructional Guide, within the teaching point for which they are required.

Prior to instructing this lesson the instructor shall:

- review the lesson content and become familiar with the material, and
- ensure there is a sufficient amount of flipchart paper and markers for the end of lesson confirmation.

PRE-LESSON ASSIGNMENT

N/A.

APPROACH

The interactive lecture method was chosen as it allows the instructor to make a semi-formal presentation of the material where the cadets can participate by asking or responding to questions and commenting on the material. For this lesson, this method is most effective as it matches well the taxonomic level of the material and is age-appropriate by virtue of its participatory nature

REVIEW

The pertinent review for this lesson will include components of an aerodrome EO M160.01 (Section 1).

OBJECTIVES

By the end of this lesson the cadet shall be expected to identify characteristics of runways including:

- numbering;
- runway lights; and
- runway markings.

IMPORTANCE

Understanding the features of a runway will be helpful during tours and familiarization flights. The various features of runways will be referred to in future aviation lessons at the squadron and the CSTC. In the aviation industry, pilots and air traffic controllers require this information to perform their jobs.

Teaching Point 1**Discuss Runway Lights**

Time: 5 min

Method: Interactive Lecture



A recommended method for presenting this information could be for the instructor to create a large runway on the floor, whiteboard or flipchart.

RUNWAY LIGHTS

Runways are lined down both sides by white lights. These lights are used to define the overall area of the runway on each side. Runways also contain red/green lights at the ends. These lights are double sided with red on one side and green on the other. The red side of the lights faces toward the runway and indicates the end of the runway. The green side faces away from the runway and shows the beginning of the runway to aircraft that are landing.

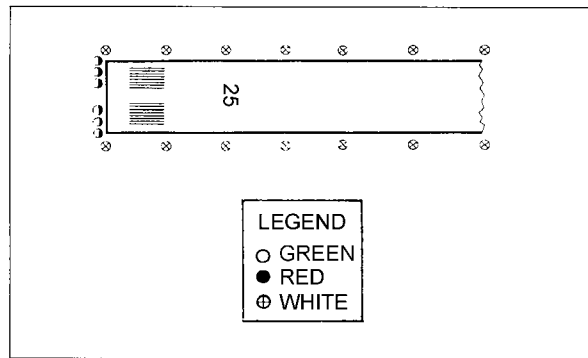

Royal Canadian Air Cadet Manual, Proficiency Level One Handbook, Cadets Canada, 1998

Figure 14-2-1 Runway Lights

CONFIRMATION OF TEACHING POINT 1**QUESTIONS**

- Q1. What colour lights define the runway on each side?
 Q2. What is the importance of the red/green lights?

ANTICIPATED ANSWERS

- A1. White lights.
 A2. They indicate the end of the runway (red side) as well as the beginning of the runway for the aircraft preparing to land (green side).

Teaching Point 2**Discuss Runway Numbering**

Time: 5 min

Method: Interactive Lecture

RUNWAY NUMBERING

The runway number is always indicated in large print as a two-digit number at the end of the runway. Runways are numbered according to their magnetic direction and are rounded off to the nearest ten degrees. Once rounded, the hundreds and tens digits are used to number the runway. For example, a runway that points in the direction of 266 degrees magnetic would be numbered 27. Therefore, the highest runway number possible is 36 (360 degrees).



Supplemental information for the instructor (do not teach): When runways run parallel, they are designated left or right (e.g. 27L and 27R). The runway number is displayed at the approach end of each runway. A single runway would, therefore, have different numbers at each of its two ends. These numbers would be 180 degrees apart. For example, runway 09 would be numbered 27 at the other end.

CONFIRMATION OF TEACHING POINT 2

QUESTIONS

- Q1. On what basis are runways numbered?
- Q2. If a runway points in the direction of 176 degrees magnetic, how would it be numbered?
- Q3. If a runway points in the direction of 43 degrees magnetic, how would it be numbered?

ANTICIPATED ANSWERS

- A1. Their magnetic direction.
- A2. 18 (Round 176 to 180, and use only the hundreds and tens digits).
- A3. 04 (Round 43 to 40, and use only the hundreds and tens digits).

Teaching Point 3**Discuss Other Runway Markings and Lights**

Time: 5 min

Method: Interactive Lecture

RUNWAY MARKINGS

Runways have other distinct markings:

- **Centerline Markings.** The centerline markings, which are white dashed lines, designate the center of the runway. Pilots use these markings to line-up the aircraft to the middle of the runway during landing.
- **Landing Zone Markings.** Landing zone markings give the pilot a general area where it is desirable to touch down.
- **Threshold Markings.** Threshold markings indicate the beginning and the end of the runway. They are indicated by white lines at the threshold.
- **Aerodrome Danger Markings.** These are areas that may be dangerous or unserviceable. These areas are signified by large white Xs on the unserviceable runways or taxiways.

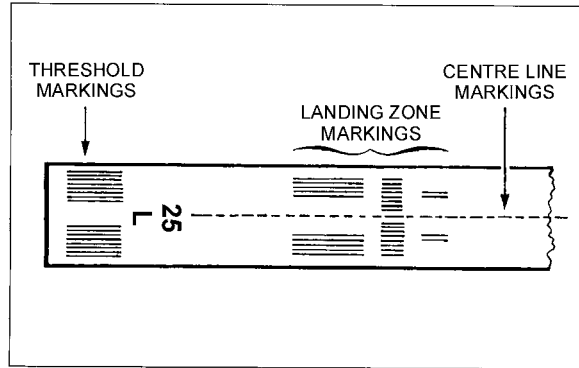

Royal Canadian Air Cadet Manual, Proficiency Level One Handbook, Cadets Canada, 1998

Figure 14-2-2 Runway Markings

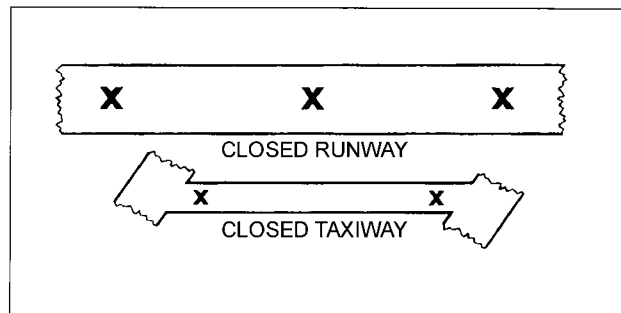

Royal Canadian Air Cadet Manual, Proficiency Level One Handbook, Cadets Canada, 1998

Figure 14-2-3 Runway Danger Markings

OTHER RUNWAY LIGHTS

Obstruction lights are present to identify possible structures that may obstruct a plane while attempting to take-off and/or land. Also, windsocks are lit so pilots can use them at night.

CONFIRMATION OF TEACHING POINT 3

QUESTIONS

- Q1. What are the markings that indicate the beginning and the end of the runway?
- Q2. What does a large white X signify on a runway or a taxiway?
- Q3. What are obstruction lights used for?

ANTICIPATED ANSWERS

- A1. Threshold markings.
- A2. Areas which may be dangerous or unserviceable.
- A3. Obstruction lights are used to identify possible structures that may obstruct a plane while attempting to take off or land.

END OF LESSON CONFIRMATION

ACTIVITY

Time: 7 min

OBJECTIVE

The objective of this activity is to confirm that the cadets can identify the various features of a runway.

RESOURCES

- flipchart paper.
- flipchart markers.

ACTIVITY LAYOUT

Divide the cadets into groups of four. Give each group a sheet of flipchart paper along with flipchart markers. The cadets will have five minutes to create a runway using the materials provided. The items that must be included on the runway are:

- threshold markings;
- red/green lights;
- runway numbers;
- center line;
- aerodrome landing markings;
- danger markings; and
- white lights.

SAFETY

N/A.

INSTRUCTOR GUIDELINES

The instructor will confirm that the cadets have included all items.

CONCLUSION

HOMEWORK/READING/PRACTICE

N/A.

METHOD OF EVALUATION

There is no formal assessment of this EO. Instructors will confirm the cadets' comprehension of the material during the end of lesson check and when they construct a model aerodrome during the activity associated with EO M160.03 (Section 3).

CLOSING STATEMENT

Being familiar with the various features of runways can assist cadets in a number of areas of their training. Understanding the features of a runway enhances cadet knowledge of aerodrome components and gives further insight into the runways' role with respect to take-off and landing procedures of aircraft.

INSTRUCTOR NOTES/REMARKS

N/A.

REFERENCES

A3-001 A-CR-CCP-263/PT-001, *From the Ground Up: Millennium Edition* (2000). Ottawa, ON: Aviation Publishers Co. Limited.



ROYAL CANADIAN AIR CADETS

LEVEL ONE

INSTRUCTIONAL GUIDE



SECTION 3

EO M160.03 – CONSTRUCT A MODEL AERODROME

Total Time:

60 min

INTRODUCTION

PRE-LESSON INSTRUCTIONS

A complete list of resources needed for the instruction of this EO is located at Chapter 2 of the QSP. Specific uses for said stores are identified throughout the Instructional Guide, within the teaching point for which they are required.

Prior to instructing this lesson the instructor shall:

- review the lesson content, and become familiar with the lesson material;
- ensure all of the materials required for the activity are present; and
- ensure the classroom layout is properly set-up before commencing the class.

PRE-LESSON ASSIGNMENT

N/A.

APPROACH

The small group activity was selected to allow for maximum participation in the learning process. It is an interactive way to illustrate and substantiate the material taught in EO M160.01 (Section 1) and EO M160.02 (Section 2).

The group discussion method was chosen to allow the cadets to share their knowledge, opinions, and feelings about the subject matter while still allowing the instructor to control the direction of the discussion. The instructor must ensure that points not brought forth by the class are presented. If the instructor follows the Instructional Guide, including the questions posed, this will allow the cadets to express, in their own words, what they learned from this lesson and how they may apply the information.

REVIEW

The pertinent review for this lesson will include:

- components of an Aerodrome EO M160.01 (Section 1); and
- features of a Runway EO M160.02 (Section 2).

OBJECTIVES

By the end of this lesson the cadet shall have constructed a model aerodrome, to include the following components:

- runway;
- taxiway;
- apron;
- hangars;
- ramp areas;
- control tower;
- terminal buildings;
- wind socks;
- flying school; and
- fire department.

IMPORTANCE

Cadets have participated in a number of classes on the components of an aerodrome. As previously stated, being able to identify the various components is very important. This knowledge will prove to be useful during aerodrome visits. Also, for anyone who has an aerodrome operation career, being able to identify and describe its components is fundamental. Being able to construct an aerodrome as a group will give cadets a greater understanding of various aerodrome components.

BACKGROUND KNOWLEDGE

RUNWAY

The runway is the area where aircraft take-off and land. A runway may be made of pavement, grass, gravel, dirt or snow among other materials. Runways are identified by numbers and by the white lights that run along each side.

Runways also contain red/green lights at the ends. These lights are double sided with red on one side and green on the other. The red side of the lights faces toward the runway and indicates the end of the runway. The green side faces away from the runway and shows the beginning of the runway to aircraft that are landing.

The runway number is always indicated in large print as a two-digit number at the end of the runway. Runways are numbered according to their magnetic direction and are rounded off to the nearest ten degrees. Once rounded, the hundreds and tens digits are used to number the runway. For example, a runway that points in the direction of 266 degrees magnetic would be numbered 27. Therefore, the highest runway number possible is 36 (360 degrees).

Runways have other distinct markings:

- **Centerline Markings.** The centerline markings, which are white dashed lines, designate the center of the runway. Pilots use these markings to line-up the aircraft to the middle of the runway during landing.
- **Landing Zone Markings.** Landing zone markings give the pilot a general area where it is desirable to touch down.
- **Threshold Markings.** Threshold markings indicate the beginning and the end of the runway. They are indicated by white lines at the threshold.

- **Aerodrome Danger Markings.** These are areas that may be dangerous or unserviceable. These areas are signified by large white Xs on the unserviceable runways or taxiways.

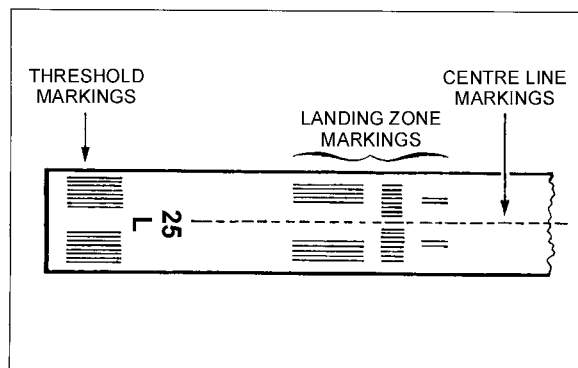

Royal Canadian Air Cadet Manual, Proficiency Level One Handbook, Cadets Canada, 1998

Figure 14-3-1 Runway Markings

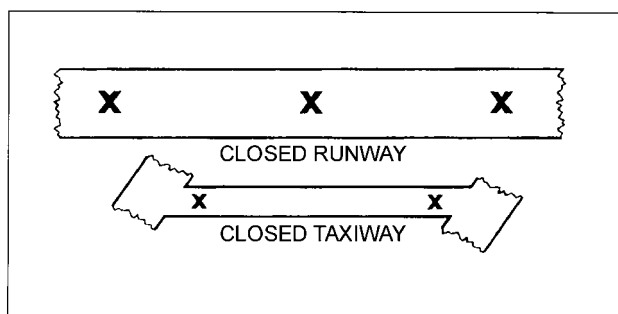

Royal Canadian Air Cadet Manual, Proficiency Level One Handbook, Cadets Canada, 1998

Figure 14-3-2 Runway Danger Markings

- **Obstruction Lights.** These lights are present to identify possible structures that may obstruct a plane while attempting to take-off and/or land. Also, windsocks are lit so pilots can use them at night.

APRON

The apron, also known as the tarmac or ramp area, is the part of an aerodrome intended to accommodate the loading and unloading of passengers and cargo. It is also the area used for refuelling, servicing and parking of aircraft.

TAXIWAY

The taxiway is the area used by an aircraft to manoeuvre around the aerodrome between aprons and runways. Taxiways are normally designated by letters. At aerodromes with lighting, taxiways are defined by blue lights along each side.

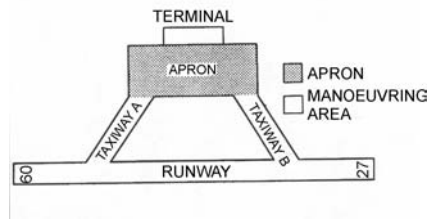

Royal Canadian Air Cadet Manual, Proficiency Level One Handbook, Cadets Canada, 1998

Figure 14-3-3 Aerodrome Movement Areas

HANGAR

The hangar is an aerodrome building that is used for storage, protection and maintenance of aircraft.

CONTROL TOWER

Some aerodromes have the service of a control tower to ensure the safe and efficient movement of aircraft. The air traffic controllers in the tower are responsible for a number of procedures (take-off/landing procedures, circuit procedures and ground manoeuvring of aircraft).

TERMINAL BUILDING

Terminal buildings are used for passengers arriving and departing and are also used for baggage and cargo handling. Terminal buildings are normally located on the apron.

WIND SOCK

All aerodromes have at least one windsock or wind t. The windsock is used by pilots to determine wind direction and speed. The approximate wind speed is indicated by the amount the windsock is extended. The wind t is designed like an arrow whose small end points into the wind. They are found on the airfield, normally beside the runway.

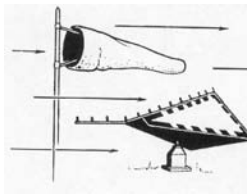

From the Ground Up: Millennium Edition, A.F. MacDonald, 2000

Figure 14-3-4 Windsock and Wind T

FLYING SCHOOL

Flying schools are used as training facilities for current pilots and those that wish to pursue such a career.

ACTIVITY – CONSTRUCT A MODEL AERODROME

Time: 35 min

OBJECTIVE

The objective of this activity is to confirm the information taught during the previous two lessons on aerodrome operations.

RESOURCES

The materials recommended for the construction of the model aerodromes are:

- Bristol board.
- Construction paper.
- Cardboard.
- Small boxes (shoe box size).
- White chalk.
- Stick pins.
- Colour markers.
- Scissors.
- Glue.
- Masking tape.



- Other materials may be used beyond this list if available at the corps/squadron.
- The amount of materials needed will depend on class size and number of groups.

ACTIVITY LAYOUT

- Place the cadets into groups of four to five.
- Inform the cadets of the materials available for them to use.
- Inform the cadets they are all to start with a base of four pieces of bristol board (two by two taped together).
- Display a diagram outlining the ideal locations for the components of a model aerodrome as detailed in Annex A.
- Have each group create their own model aerodrome, ensuring all of the components are properly labelled.



While cadets are encouraged to be creative with the materials provided, the instructor may recommend the following uses for the resources listed above:

- cardboard, poster board and small boxes – can be used for the construction of small buildings;
- white chalk – can be used for runway numbering and markings on bristol board;
- multi-coloured markers – can be used for labelling the various components and adding specific details to them;
- construction paper – can be used with cardboard/small boxes if a specific colour for the building/component is required;
- stick pins – can be used for the lighting at an aerodrome (taxiway and runway lights); and
- glue and masking tape – can be used to hold the various components together.

SAFETY

N/A.

INSTRUCTOR GUIDELINES



At this point the instructor shall brief the cadets on any safety rules or any other guidelines pertaining the activity.

- Ensure the cadets share the supplies when creating model aerodromes.
- Assist groups in getting started if they are having difficulty.
- Supervise the cadets' work to ensure that they are following the instructions listed above.
- Once the activity has been completed, the instructor should examine the model aerodromes to ensure that all of the components are labelled properly and in their proper locations.
- After this activity has been completed, the instructor should carry on with the reflection/questioning stage.

REFLECTION

Time: 10 min

DISCUSSION QUESTIONS



TIPS FOR ANSWERING/FACILITATING DISCUSSION

- Ask questions that help facilitate discussion; in other words, avoid questions with yes or no answers.
- Prepare questions ahead of time.
- Be flexible (you are not bound to only the prepared questions).
- Encourage cadets to participate by using praise such as “great idea” or “excellent response, can anyone add to that?”.
- Try to involve everyone by directing questions to non-participants.

SUGGESTED QUESTIONS

Q1. How did the information from the last two lessons help in creating the model aerodrome?



Review the material by asking the following questions, using the models created by the cadets as training aids. Identify the various components of an aerodrome and runway that were discussed in previous classes.

SUGGESTED QUESTIONS

- Q1. What is the significance of runway markings?
- Q2. What are taxiways used for?
- Q3. What is the significance of the red/green runway lights?

SUGGESTED ANSWERS

- A1. Runway markings assist pilots in determining things such as recommended areas for take-off/touch down (threshold markings) as well as areas that are potentially unsafe (hazard markings).
- A2. Taxiways are used by pilots to move planes from the apron to the runway, or between aprons themselves.
- A3. They indicate the end of the runway (red side) as well as the beginning of the runway for the aircraft to land (green side).

CONCLUSION

REVIEW

Upon completion of the group discussion conclude by summarizing to ensure that all teaching points have been covered. Take the opportunity to explain how the cadet will apply this knowledge in the future.

MAIN TEACHING POINT

TP1. Describe the components of an aerodrome.

TP2. Describe the features of a runway.



Instructors shall reinforce those answers and comments discussed during reflection, but must ensure that the main teaching points have been covered. Any main teaching point not brought out during the group discussion shall be brought during review.

HOMEWORK/READING/PRACTICE

N/A.

METHOD OF EVALUATION

There is no formal assessment of this EO.

CLOSING STATEMENT

The last several EOs within aerodrome operations have focused on the components of aerodromes. Moving from an overview of the components to specific features has given a deeper insight into how aerodromes are structured. Furthermore, completing the exercise of constructing a model aerodrome should increase the cadets' knowledge of the description and location of the various components.

INSTRUCTOR NOTES/REMARKS

N/A.

REFERENCES

- A3-001 A-CR-CCP-263/PT-001, *From the Ground Up: Millennium Edition* (2000). Ottawa, ON: Aviation Publishers Co. Limited.
- C3-022 (ISBN 0-19-541731-3) *The Canadian Oxford Dictionary* (2001). Don Mills, ON: Oxford University Press.

AIRPORT FAMILIARIZATION



Figure 14A-1 Runway

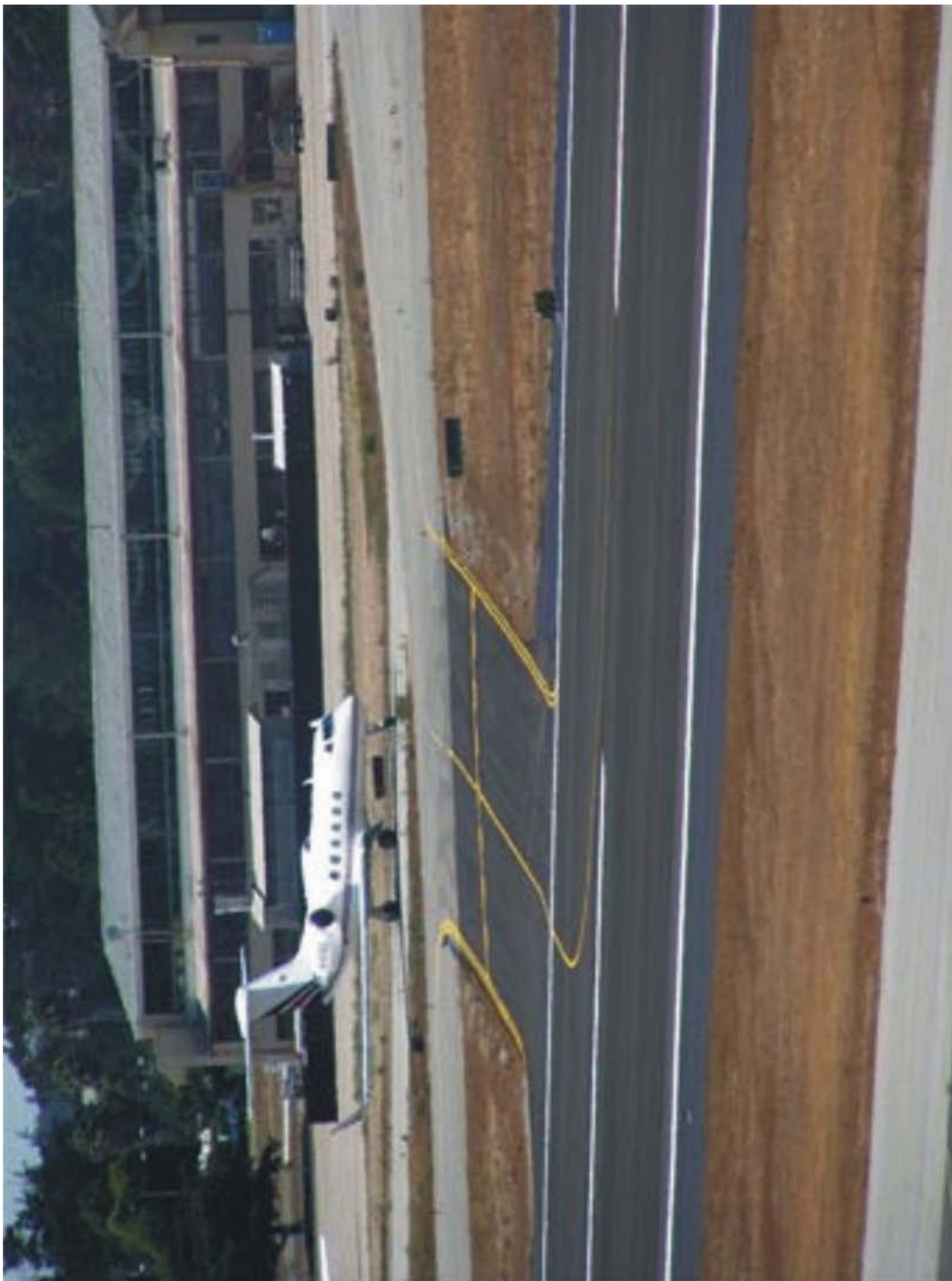

Figure 14A-2 Taxiway



Figure 14A-3 Apron



Figure 14A-4 Hangar



Figure 14A-5 Control Tower



Figure 14A-6 Terminal Building



Figure 14A-7 Windsock

CHAPTER 15

PO 190 – PARTICIPATE IN A FIELD EXERCISE



ROYAL CANADIAN AIR CADETS

LEVEL ONE

INSTRUCTIONAL GUIDE



SECTION 1

EO M190.01 – PACK PERSONAL EQUIPMENT FOR A FIELD EXERCISE

Total Time:	60 min
-------------	--------

INTRODUCTION

PRE-LESSON INSTRUCTIONS

A complete list of resources needed for the instruction of this EO is located at Chapter 2 of the QSP. Specific uses for said stores are identified throughout the Instructional Guide, within the teaching point for which they are required.

Prior to instructing this lesson the instructor is required to:

- review the lesson content, and become familiar with the material;
- prepare a suitable instructional area;
- prepare a properly packed rucksack or backpack in accordance with the principles outlined in this lesson;
- ensure the rucksack or backpack includes all of the materials discussed in this lesson; and
- have a knife available.

PRE-LESSON ASSIGNMENT

N/A.

APPROACH

The interactive lecture method was chosen as it allows the instructor to make a semi-formal presentation of the material where the cadets can participate by asking or responding to questions and commenting on the material. For this lesson, this method is most effective as it matches well the taxonomic level of the material and is age-appropriate by virtue of its participatory nature.

The small group activity was selected to allow for maximum participation in the learning process. It is an interactive way to illustrate and substantiate the lesson material in a concrete manner.

The demonstration and performance method was chosen due to the practical nature of the subject matter. These methods provide the instructor the opportunity to introduce the subject matter, demonstrate procedures and observe the cadets practicing and performing the skill. The demonstration and performance methods must always be used when the taxonomic level of the material requires a performance of a skill. These methods are highly developmentally appropriate for young cadets.

REVIEW

N/A.

OBJECTIVES

By the end of this lesson the cadet shall be expected to select and pack appropriate personal equipment for field training.

IMPORTANCE

Selecting and packing the appropriate clothing is a key element of field training. Weather can be a large factor in a survival situation. Selecting the right clothing can help prevent unnecessary injury and weather-related illnesses. Improper packing techniques can cause discomfort and possible injury.

Teaching Point 1**Select Field Clothing**

Time: 20 min

Method: Interactive Lecture/Activity

THE LAYERING PRINCIPLE**The Core Layer (Upper Body)**

This layer lies next to the skin. It should consist of a wool or synthetic undershirt or a long-sleeved thermal top. The garment should be close fitting but not tight. It should be made of a material that will absorb perspiration and move it away from the skin. This layer must be kept as clean as possible to prevent dirt from clogging the pores of the fabric.

The Second Layer

The second layer should be loose fitting and should keep the blood vessels of the neck and wrists protected and warm. It could consist of a zip-up top with a high neck or a shirt with a collar. Sleeves should be able to be rolled up and cuffs should be able to be buttoned. In hot weather, this layer may be used as an outer layer.

The Outer Layer

The outer layer should be a jacket that is both wind-resistant and waterproof depending on the climate. For example, in the Arctic, a padded, windproof parka is required for protection against cutting winds and extreme cold. You must be able to vent your jacket to avoid becoming overheated. In temperate areas, rain is the most common cause of cold discomfort. Waterproof outerwear should be worn.

Underwear (Lower Body)

Long thermal underwear is usually necessary only in temperatures below freezing. In the Arctic a “groin patch” of impermeable material prevents wind chill in that area. If your underwear gets wet, it will eventually dry. However, this problem can be avoided by wearing waterproof pants. In mild weather, this layer may consist of cotton shorts.

Pants

Pants should allow freedom of movement and should be able to dry quickly. In very wet conditions, using a belt helps to prevent chaffing at the waist. Waterproof pants can be worn to help protect your legs from rain, but may cause overheating. In very cold conditions, quilted over-trousers should be zipped over pants and boots for added protection.



If available, the instructor shall show examples of each piece of clothing during the explanation.

ADVANTAGES AND DISADVANTAGES OF FABRICS

Wool

Advantages. Wool has insulating properties even when wet. It remains comfortable until it is soaked and smolders rather than melts when exposed to excessive heat.

Disadvantages. It is heavy when wet and takes time to dry. When it is worn next to skin, it may cause itching, and may shrink when washed.

Cotton

Advantages. Cotton is durable, breathable and absorbs moisture. It is a good fabric for underwear and items worn next to the skin in warm climates.

Disadvantages. It may be heavy when wet and can shrink if it is dried at high temperatures. It may tear and burn easily. Also, it is not windproof.

Fleece or Pile

Advantages. As an outer layer, fleece forces moisture away from the body while keeping it warm. It is lightweight, Hardwearing and does not absorb moisture.

Disadvantages. Fleece is not windproof and does not compress easily. It can collect balls of fluff on the outside after long use.

Synthetic Fabrics

Advantages. These fabrics allow sweat to evaporate while keeping rain and other moisture out. They are usually windproof and an excellent choice for an outer layer.

Disadvantages. The seams may come apart in water. In very wet conditions the fabric pores may become clogged. The evaporation of sweat from the outside of the fabric may result in heat loss.



When finished delivering the above material, the instructor may present an acronym that can be used to remember the principles to be practiced when selecting and wearing clothing in the field.

COLD: Keep the garment **C**lean, **A**void **O**verheating, **W**ear it **L**oose and **L**ayered, **K**eeP it **D**ry.

FOOTWEAR

Socks

Thick socks made of either wool or fiber-pile cotton are vital. Socks keep your feet warm, dry and prevent footwear from rubbing against skin. Rubbing can cause blisters and chafing. In cold weather, two pairs of socks, an outer layer and an inner layer, should be worn. The inner layer will force moisture away from the foot and move it to the outer layer to keep the foot dry. Socks should be changed daily before bed.

Boots

Boots with a hard sole and good cushion are just as important as socks. Being comfortable and stable can make for a more enjoyable time in the field. Ankle support is important in the prevention of ankle injury.

WEATHER CONSIDERATIONS

It is important to be prepared for any type of weather. Wear a toque, scarf and mitts during cold weather. The toque will prevent heat from being lost through the head. Mitts will prevent injuries like frostbite by keeping hands warm and blood circulating. During warm conditions, it is important to wear sunscreen and a hat to be protected from the sun. Extended exposure to the sun can cause burns and sunstroke.

CONFIRMATION OF TEACHING POINT 1

QUESTIONS

- Q1. What is one advantage to wearing wool?
- Q2. What is the core layer, worn on the upper body?
- Q3. What is one disadvantage to synthetic fabrics?

ANTICIPATED ANSWERS

- A1. Wool has insulating properties even when wet, remains comfortable until it is soaked, and smolders rather than melts when exposed to excessive heat.
- A2. This layer lies next to the skin and should consist of a wool or synthetic undershirt or a long-sleeved thermal top.
- A3. Seams may come apart in water. In very wet conditions, the fabric pores may become clogged. The evaporation of sweat from the outside of the fabric may result in heat loss.

ACTIVITY

Time: 10 min

OBJECTIVE

The objective of this activity is to confirm TP1 by having the cadets dress up one of their peers in proper clothing for the field and the climate.

RESOURCES

- Clothes that represent the layering principle, to include:
 - A core layer.
 - A second layer.
 - An outer layer.
 - Underwear.
 - Pants.
- Clothing that is made of the different types of fabric listed in TP1.
- Appropriate footwear.

ACTIVITY LAYOUT

- Have the clothing laid out according to its category prior to starting the activity.

- Assign a cadet to be the “model”. The selected cadet will be the one to wear the clothing.
- Question the cadets on what piece of clothing the cadet should put on first in accordance with the layering principle.
- This should continue until the cadet is fully clothed for the field.
- When the cadet is dressed, the instructor shall question the cadets on the advantages and disadvantages of the type of clothing chosen for each layer (this might be easier when the cadet is taking each layer off).

SAFETY

N/A.

INSTRUCTOR GUIDELINES

- Ensure that the cadet selected as the model has appropriate clothing on prior to them putting on the layers of clothes. By no means shall the cadet be in undergarments before the activity commences. Clothing can be put on over the uniform or appropriate civilian clothing.
- Ensure that the questioning remains controlled.
- Another instructor may be used as the model.

Teaching Point 2

Explain, Demonstrate and Have Cadets Pack Personal Equipment for Field Training

Time: 25 min

Method: Demonstration and Performance

PACKING PERSONAL EQUIPMENT

While packing a kit, ensure to place a large plastic bag inside the pack prior to packing it. This will block moisture from reaching the contents. Each item should also be placed in a separate bag with the extra air removed to save as much space as possible. Place items in the pack by priority, with the most frequently used items on top or where easily accessible. The equipment needs to be placed in the pack so the weight is distributed and balanced appropriately. A poorly balanced pack can cause fatigue. The heaviest items should be placed near the bottom or the back of the pack to avoid back strain. Ensure all items are secured to the pack to avoid losing items and having to constantly stop for adjustments.

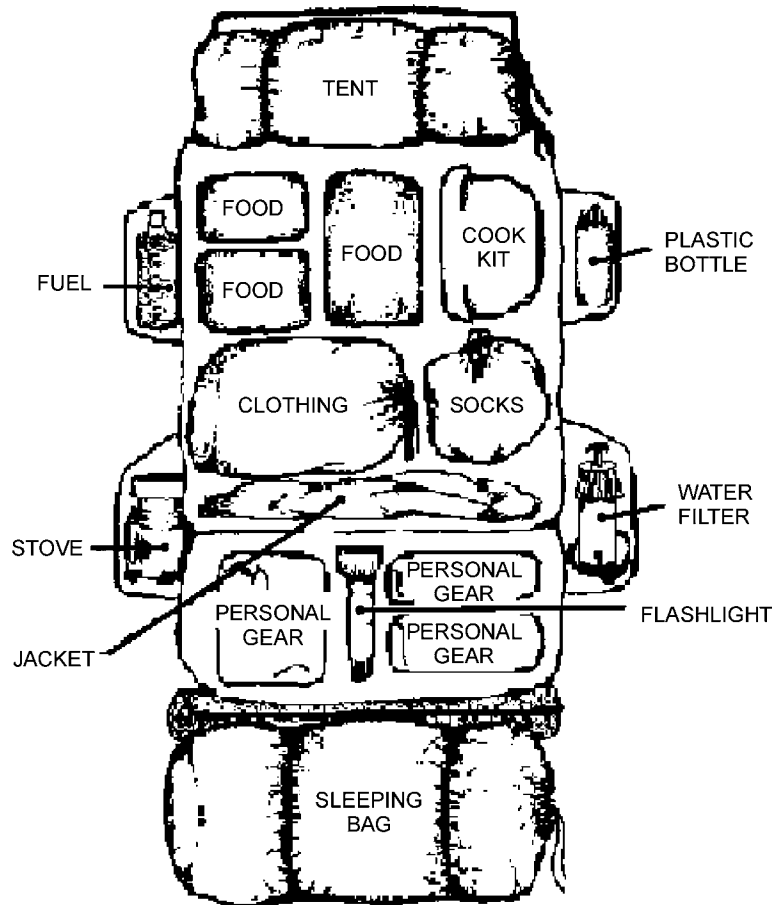

Basic Essentials Backpacking, Harry Roberts, 1989

Figure 15-1-1 A Well-organized Backpack

The tent should be placed on top of the pack with the sleeping bag and pad firmly attached under the backpack. Food, clothing and a cooking kit are examples of what to place in the backpack itself. Clothing should include extra socks, undergarments and polypropylene/synthetic T-shirt and pants. Personal gear could include a first aid kit, waterproofed matches, flashlight, emergency candle and hygienic items. Items such as water bottle, stove, fuel canister, flashlight and a water filter can fit in the side pouches of the bag.



Where practical, this teaching point should be conducted using the demonstration and performance method. The instructor should demonstrate the packing of a backpack with the cadets performing the skill immediately after. The following activity will assist in allowing the cadets to practice the skill. Where the instructional environment does not allow for this option, the teaching point will be delivered using the demonstration method only, with the cadet packing their bags on their own time.

ACTIVITY

Time: 15 min

OBJECTIVE

To allow the cadet to practice effective techniques of packing personal equipment prior to participating in an aircrew survival exercise.

RESOURCES

- Rucksack/backpack.
- Various personal equipment (brought by cadet).

ACTIVITY LAYOUT

- While delivering this teaching point, the instructor shall demonstrate how to effectively pack a backpack for the field.
- The cadets shall pack their own bag during this time following the instructor's example.

SAFETY

N/A.

INSTRUCTOR GUIDELINES

- Supervise the cadets' packing method closely.
- It is advisable to have other instructors assigned to provide additional supervision and feedback to cadets during this activity.
- If the cadets do not bring their own kit, ensure that an interactive demonstration of each packing step is given.

CONFIRMATION OF TEACHING POINT 2

QUESTIONS

- Q1. Why should a large plastic bag be placed inside the backpack prior to packing it?
- Q2. What does a poorly balanced backpack cause?

ANTICIPATED ANSWERS

- A1. This will block the moisture from getting at the contents.
- A2. A poorly balanced pack can cause fatigue.

END OF LESSON CONFIRMATION

This lesson shall be confirmed by verbal questioning.

CONCLUSION

HOMEWORK/READING/PRACTICE

N/A.

METHOD OF EVALUATION

There is no formal assessment of this EO. Instructors shall confirm the cadets' comprehension of the material during the end of lesson check and during the kit inspection conducted prior to departing on the overnight aircrew survival exercise.

CLOSING STATEMENT

Cadets have identified the appropriate clothes to bring with them to the field and how to effectively pack them. Selecting and packing approximately will help prevent fatigue and cold while in the field. Weather can be a large factor influencing survival. If one selects the right clothing, unnecessary injury and weather illnesses can be prevented. Improper packing techniques can cause discomfort and possible injury. It is important to ensure that equipment is packed properly prior to leaving for an aircrew survival exercise.

INSTRUCTOR NOTES/REMARKS

N/A.

REFERENCES

- C3-003 (ISBN 1-896713-00-9) Tawell, P. (1996). *Camping and Wilderness Survival: The Ultimate Outdoors Book*. Green Valley, ON: Fifteenth Printing.
- C3-021 (ISBN 0-7715-9035-0) McManners, H. (1994). *The Complete Wilderness Survival Manual*. Somewhere, BC: McMillan Canada.
- C3-024 (ISBN 0-7627-0476-4) Roberts, H. (1989). *Basic Essentials Backpacking*. Guildford, CT: The Globe Pequot Press.



ROYAL CANADIAN AIR CADETS

LEVEL ONE

INSTRUCTIONAL GUIDE



SECTION 2

EO M190.02 – MAINTAIN PERSONAL EQUIPMENT AND HYGIENE IN THE FIELD

Total Time: 30 min

INTRODUCTION

PRE-LESSON INSTRUCTIONS

A complete list of resources needed for the instruction of this EO is located at Chapter 2 of the QSP. Specific uses for said stores are identified throughout the Instructional Guide, within the teaching point for which they are required.

Prior to instructing this lesson the instructor is required to:

- review the lesson content, and become familiar with the material;
- prepare a suitable instructional area;
- prepare a properly packed rucksack/backpack in accordance with the principles delivered in this lesson; and
- prepare resources for practicing field hygiene.

PRE-LESSON ASSIGNMENT

N/A.

APPROACH

The interactive lecture method was chosen as it allows the instructor to make a semi-formal presentation of the material where the cadets can participate by asking or responding to questions and commenting on the material. For this lesson, this method is most effective as it matches well the taxonomic level of the material and is age-appropriate by virtue of its participatory nature.

REVIEW

N/A.

OBJECTIVES

By the end of this lesson the cadets shall be expected to care for their own personal equipment, care for a knife and maintain hygiene while in the field.

IMPORTANCE

Caring for personal equipment and knowing how to safely use a knife will prevent unnecessary injury. Practicing field hygiene principles will contribute to the successful conduct of an aircrew survival exercise by preventing illness and maintaining a safe environment.

Teaching Point 1**Explain How to Care for Personal Equipment While in the Field**

Time: 7 min

Method: Interactive Lecture

CARE FOR CLOTHING

All articles of clothing shall be kept as clean as possible. Dirt can get through some clothing and reach the skin. Sweat and dirt may cause skin irritation. The dirt may also get into the fibres of the fabric and destroy the insulation value. This potential loss of insulation is why undergarments must be changed daily.

Change socks as often as possible. Wet or dirty socks can cause blisters and other skin irritations. Wash socks in lukewarm water. Carefully rinse out all of the soap, squeeze out the water, and stretch the socks back into shape. Socks should be kept in good repair and holes mended as soon as they appear.

Boots should be properly maintained by keeping them dry and soft. Boots should never be placed too close to the fire.

CONFIRMATION OF TEACHING POINT 1

QUESTIONS

- Q1. Why must undergarments be changed daily?
- Q2. What are the steps to take when laundering socks?

ANTICIPATED ANSWERS

- A1. Dirt can get through some clothing and reach the skin. Combined with sweat, the dirt may cause considerable irritation.
- A2. When laundering socks, use lukewarm water. Carefully rinse out all of the soap, squeeze out the water, and stretch the socks back into shape.

Teaching Point 2**Use a Knife in the Field**

Time: 9 min

Method: Interactive Lecture

CARE OF KNIVES IN THE FIELD**Safety Precautions**

A knife should be kept sharp and carried in a suitable sheath. It should be returned to its sheath immediately after use and remain there when not in use. Always position the sheath on a waist belt towards the back of the hip. This positioning will prevent the knife from being driven into the groin during a fall. Never angle the blade in another person's direction or at yourself. Always pass a knife closed or by presenting the handle to the person receiving it. Ensure the person receiving the knife is ready to accept the knife before letting go. Ensure that the sharp side of the blade is facing up when passing the knife. Always ensure knives are put away or safely stored.

Sharpening

Use a quality sharpening stone and apply a lubricant as specified for the stone. Place the blade on the stone and pull it toward you in a circular motion and repeat this action. Ensure that this motion is completed an equal number of times on both sides. When sharpening the blade, try to maintain the original angle of the cutting

edge. Sharpen the knife blade when it becomes dull. To polish a blade that has stains on it, use wood ash found in a fire pit. Wood ash rubbed on a stained blade will remove the stains without scratching the blade.



1. Moisten the sharpening stone with water. Stroke the knife on the stone, away from the edge of the blade.

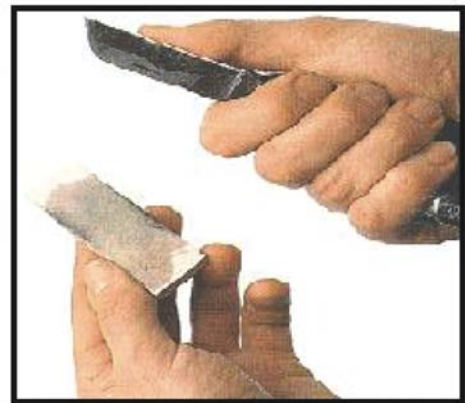

2. After sharpening the knife on one side, feel the other side for the burr of metal turned up by the abrasion.



3. Smooth the other side of the blade, realigning the burr to the centre. More water may be needed.

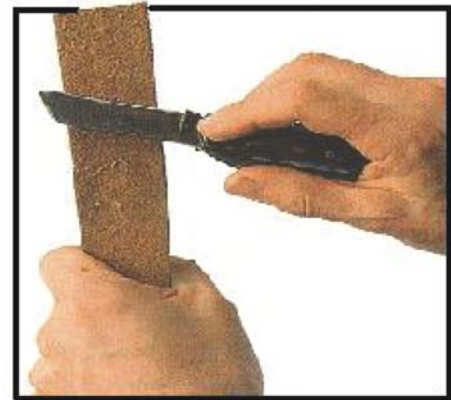

4. Strop the knife (sweep it up and down) on a leather belt. This will help smooth off and strengthen the edge.

The Complete Wilderness Survival Manual, Hugh MacManners, 1994

Figure 15-2-1 Steps to Knife Sharpening

CONFIRMATION OF TEACHING POINT 2

QUESTIONS

- Q1. What is the proper action to take when sharpening a knife?
- Q2. Where should the knife blade not be pointed?
- Q3. When passing the knife, which way should the blade be facing?

ANTICIPATED ANSWERS

- A1. Place the blade on the stone and pull it toward you in a circular motion and repeat this action many times. Ensure that this motion is completed an equal number of times on both sides.
- A2. In another person's direction or at yourself.
- A3. Up.

Teaching Point 3

Explain How to Maintain Hygiene in the Field

Time: 10 min

Method: Interactive Lecture

FIELD HYGIENE REQUIREMENTS

Keeping healthy is an important factor for survival in the field. Strict hygiene routines should be practiced personally and at the survival site. Garbage and latrines shall be kept away from the site to avoid the threat of insects and illness. Proper hygiene practices will also ensure drinking water is not contaminated.

WASHING IN THE FIELD

In order to keep clean, use soap and water while in the field. Special attention should be given to the crotch, scalp and between the toes. These areas are susceptible to rash and fungus infections. A daily shower with hot water and soap is ideal. If a shower is not feasible, keep hands as clean as possible. The face, armpits, crotch and feet should be washed and dried at least once a day. If soap is unavailable, wood ash can be used as a substitute. Washing daily can prevent the growth and spread of germs.

DENTAL CARE IN THE FIELD

Teeth should be cleaned with a toothbrush and toothpaste after every meal and before bed. Table salt or baking soda can be used as a substitute for toothpaste. If a toothbrush is not available, a green twig can be chewed to a pulpy consistency. The mouth should be rinsed with water after every meal.

DISPOSAL OF WASTE

It is very important to manage waste effectively. Wet and dry garbage shall be separated into different sealed containers. It should be stored downwind and a suitable distance from the site. Water that is used to clean dishes, bodies, teeth or clothes is called grey water. This water must be disposed of by placing it in containers located near the washstands or latrines. Solid garbage shall be packed out of the site. If it is packed in, it should be able to be packed out. It is the responsibility of each member to ensure that no trace of waste is left behind.



Where appropriate, the instructor shall indicate the locations associated with this teaching point. These include but are not limited to:

- washstand;
- latrines;
- port-o-potties;
- grey water disposal area; and
- wet and dry garbage disposal area.

CONFIRMATION OF TEACHING POINT 3

QUESTIONS

- Q1. If a shower is not available, what parts of the body should one ensure to clean?
- Q2. What can be used as a substitute for toothpaste?
- Q3. What is grey water?

ANTICIPATED ANSWERS

- A1. Hands, faces, armpits, crotch and feet.
- A2. Table salt or baking soda.
- A3. Water that has been used to clean clothes, dishes, teeth, bodies etc.

END OF LESSON CONFIRMATION

This lesson shall be confirmed by verbal questioning.

CONCLUSION

HOMEWORK/READING/PRACTICE

N/A.

METHOD OF EVALUATION

There is no formal assessment of this EO.

CLOSING STATEMENT

Cadets have learned how to care for their personal equipment, use a knife and maintain personal hygiene in the field. Caring for personal equipment and safely using a knife while in the field is of the utmost importance.

INSTRUCTOR NOTES/REMARKS

N/A.

REFERENCES

- C3-003 (ISBN 1-896713-00-9) Tawell, P. (1996). *Camping and Wilderness Survival: The Ultimate Outdoors Book*. Green Valley, ON: Fifteenth Printing.
- C3-021 (ISBN 0-7715-9035-0) McManners, H. (1994). *The Complete Wilderness Survival Manual*. BC: McMillan Canada.

THIS PAGE INTENTIONALLY LEFT BLANK



ROYAL CANADIAN AIR CADETS

LEVEL ONE

INSTRUCTIONAL GUIDE



SECTION 3

EO M190.03 – OBSERVE SITE POLICIES AND PROCEDURES

Total Time:	60 min
-------------	--------

INTRODUCTION

PRE-LESSON INSTRUCTIONS

A complete list of resources needed for the instruction of this EO is located at Chapter 2 of the QSP. Specific uses for said stored are identified throughout the Instructional Guide, within the teaching point for which they are required.

Prior to instructing this lesson the instructor shall:

- review the lesson content, and become familiar with the material; and
- gather flipchart paper and markers.

PRE-LESSON ASSIGNMENT

N/A.

APPROACH

The interactive lecture method was chosen as it allows the instructor to make a semi-formal presentation of the material where the cadets can participate by asking or responding to questions and commenting on the material. For this lesson, this method is most effective as it matches well the taxonomic level of the material and is age-appropriate by virtue of its participatory nature.

REVIEW

N/A.

OBJECTIVES

By the end of this lesson the cadet shall be expected to observe all site policies and procedures during an aircrew survival exercise.

IMPORTANCE

It is important to know and follow established site policies and procedures to ensure the site is maintained and functioning in a smooth and safe manner.

Teaching Point 1**Describe Safety Issues Related to Field Training**

Time: 10 min

Method: Interactive Lecture

GENERAL SAFETY

Cadets should be aware that running, engaging in horseplay or wandering off from the group is not acceptable behaviour during field training.



Other general safety concerns should be presented to the cadets at this point. These other concerns will be specific to the site where the activity is being conducted and will be contained in the operation order for the exercise.

MEDICAL PROCEDURES

In case of a medical emergency, all members need to be aware of actions that need to be taken. Members need to know where the first aid area is located, where to get medications, what to do if they come across a medical emergency, the muster point in case an evacuation needs to take place and who is in charge of, or trained in, first aid.



Other medical procedures should be presented to the cadets at this point. These other procedures will be specific to the site where the activity is being conducted and will be contained in the operation order for the exercise.

ENVIRONMENTAL PROCEDURES

It is extremely important that the environment is respected while conducting a weekend exercise. Garbage and grey water should be disposed of in designated areas. Cutting down live trees, including breaking branches is not acceptable. Doing this may hinder the growth of the tree. In case of an environmental spill, cadets should advise staff members immediately and local authorities should be contacted.



Other environmental procedures should be presented to the cadets at this point. These other procedures will be specific to the site where the activity is being conducted and will be contained in the operation order for the exercise.

CONFIRMATION OF TEACHING POINT 1

QUESTIONS

- Q1. What behaviour is not acceptable in the field?
- Q2. What medical procedures need to be known by personnel?
- Q3. Why should one not break branches off of a live tree?

ANTICIPATED ANSWERS

- A1. Running, engaging in horseplay and wandering off from the group.

- A2. Where the first aid area is located, what to do if they come across a medical emergency, the muster point in case an evacuation needs to take place and who is in charge of, or trained in, first aid.
- A3. It may hinder the growth of the tree.

Teaching Point 2

Explain the Fire Regulations in Place at the Training Site

Time: 10 min

Method: Interactive Lecture

FIRE PROCEDURES

All personnel need to be aware of what to do in case of a fire. If a member notices a fire they should shout “fire, fire, fire” and use a siren or whistle to sound an alarm. Upon hearing the alarm, all personnel should meet at the designated muster point. The member who noticed the fire should present themselves to the senior officer on site.

MUSTER POINT

The muster point is the area designated for all people at the site to gather together in case of a fire or other emergency. It should be located away from hazardous areas and near the best route out of the campsite.

FIRE FIGHTING EQUIPMENT

The fire pit location should contain basic fire fighting equipment such as fire extinguishers, fire brooms and buckets.



The instructor should take the class to each area presented above and ensure everyone is clear on the fire regulations.

ACTIVITY

Time: 5 min

OBJECTIVE

The objective of this activity is to conduct a fire drill.

RESOURCES

N/A.

ACTIVITY LAYOUT

1. Choose a cadet to “find” the fire.
2. Have that cadet carry out the proper procedures when locating a fire.
3. The rest of the group should carry out the proper procedures (report to the muster point) upon hearing the cadet shout “fire, fire, fire.”

SAFETY

Ensure the area is free of obstacles that may cause cadets to fall or hurt themselves during the fire drill.

INSTRUCTOR GUIDELINES

During the drill, the instructor shall supervise and ensure all cadets are carrying out the proper procedures for a fire.

CONFIRMATION OF TEACHING POINT 2

QUESTIONS

- Q1. What is the muster point?
- Q2. What fire fighting equipment should be present at the campsite?
- Q3. What should one do when noticing a fire?

ANTICIPATED ANSWERS

- A1. The muster point is the area designated for all people who are at the campsite to gather together in case of a fire or other emergency.
- A2. Basic fire fighting equipment such as extinguishers, fire brooms and buckets.
- A3. Shout “fire, fire, fire” and move to the muster point. The member who noticed the fire should present themself to the senior officer.

Teaching Point 3

Give an Overview of Layout of the Bivouac Site

Time: 10 min

Method: Interactive Lecture



This teaching point should be presented at each of the locations listed.

COMMAND POINT/HEADQUARTERS

The command tent should be located in a centralized area and all personnel at the site should know its location.

FIRST AID AREA

The first aid area must be equipped with at least one stretcher, a well-stocked first aid kit and any additional equipment needed when treating minor injuries.

TENT/SHELTER AREAS

Tents are usually divided into two groups, one for males and one for females. All tents should be erected at least 10 feet apart with the doors opposite the prevailing winds.

FIRE PIT

Fire pits must be at least 100 meters away from the campsite and strictly in open areas. Permission to have a fire pit must be granted by local authorities and the forest fire rating must be of a safe nature.

LATRINES

If at all possible, before building a latrine, make use of an outhouse that may already be available. If a latrine must be built, construct it as least 100 meters away from the campsite and not too close to the source of water. Local regulations should be consulted before building latrines.

PETROLEUM, OIL AND LUBRICANT (POL) POINT

POL stands for Petroleum, Oils and Lubricants. The storage area for these materials must be located at a reasonable distance from the bivouac site. Access to this area is limited.

WATER POINT

Drinking water should be obtained from a reliable source. Always boil water that is collected in the field to purify it. If collecting water from a fast moving stream, always get water upstream away from washing and laundry areas.

WET AND DRY GARBAGE AREAS

Garbage should be bagged and removed from the bivouac site. There should be separate areas for wet and dry garbage and these areas should be marked clearly. Grey water should be disposed of in this area as well.



At this point, the instructor should identify any other areas that may be used during the exercise.

CONFIRMATION OF TEACHING POINT 3

QUESTIONS

- Q1. What does POL stand for?
- Q2. Where should the fire pit be located?
- Q3. If collecting water from a fast moving stream, where should it be collected?

ANTICIPATED ANSWERS

- A1. Petroleum, oils and lubricants.
- A2. Fire pits must be at least 100 meters away from the campsite and strictly in open areas.
- A3. Upstream away from the washing and laundry areas.

Teaching Point 4

Discuss Safety Measures With Regards to Animals

Time: 15 min

Method: Interactive Lecture

POTENTIAL ANIMALS

There is potential to run into many different animals when in the wilderness. Some of these animals could include:

- bears;

- cougars;
- rattlesnakes;
- moose;
- bison;
- elk; and
- wolves.

With each of these animals, it is important to be aware of preventative measures to avoid them. One should also be aware of actions to take if an encounter occurs.

BEARS

Preventative measures to avoid an encounter with a bear include:

- looking for signs that a bear may be close. Signs include tracks and scat in the area;
- have the kitchen separate from the training site. Bears are attracted to food so having the kitchen separate will deter the bear from entering the training site; and
- making noise to deter the bear from coming in the general area.

Defence measures to take in an encounter with a bear include:

- using pepper spray;
- using a shotgun;
- grouping everyone together to expand presence; and
- playing dead versus fighting fiercely.

COUGARS

Preventative measures to avoid an encounter with a cougar include:

- hiking in groups; and
- making noise to deter the cougar from coming in the general area.

Defence measures to take in an encounter with a cougar include:

- not running;
- grouping together to expand presence;
- speaking loudly;
- providing an escape route for the animal;
- facing the cat and maintaining eye contact;
- fighting back if attacked; and
- if attacked from behind, throwing the cat overhead and forward.

RATTLESNAKES

Preventative measures to avoid an encounter with a rattlesnake include:

- watching where steps are taken;
- looking closely before parting bushes;
- using a stick, not hands, when turning over stones or rocks;
- wearing stout boots; and
- checking bedding and clothes packs before using.

Defence measures to take in an encounter with a rattlesnake include:

- do not tease or pick up;
- do not make sudden movements, back off slowly and remain calm; and
- if bitten, back away immediately and immobilize the bitten area, below the heart if possible; and
- do not tie a tourniquet or attempt to suck out the venom. Report to the nearest hospital as soon as possible.

WOLVES

Preventative measures to avoid an encounter with a wolf include:

- cooking and washing dishes away from campsite;
- hanging food and garbage away from sleeping area; and
- keeping pets close at all times.

Defence measures to take in an encounter with a wolf include:

- looking larger, raising and waving arms;
- making noise;
- throwing objects, like sticks, rocks, pots and pans;
- backing away slowly, do not turn away from the animal especially if your head is lowered; and
- keeping direct eye contact.

MOOSE, ELK AND BISON

Moose, elk and bison are only likely to charge when threatened or crowded. To prevent an attack, distance should be kept from the animal.

ACTIVITY

Time: 10 min

OBJECTIVE

The objective of this activity is for the cadets to discuss the preventative and defence procedures for the animals presented in this teaching point.

RESOURCES

- Flipchart paper.
- Flipchart markers.

ACTIVITY LAYOUT

- Divide the group into five teams.
- Give each team a piece of flipchart paper and a marker.
- Designate each group as an animal discussed in the teaching point.
- Have each group discuss and write the preventative and defence measures for their animal.
- After five minutes, have each group present their animals.

SAFETY

N/A.

INSTRUCTOR GUIDELINES

During the activity, supervise and ensure all cadets are participating in the activity. Praise and correct the cadets as necessary.

END OF LESSON CONFIRMATION

The end of lesson confirmation will consist of the class walking to each of the locations and explaining each of them. A different cadet should be chosen to explain each of the locations.

CONCLUSION

HOMEWORK/READING/PRACTICE

N/A.

METHOD OF EVALUATION

There is no formal assessment of this EO.

CLOSING STATEMENT

It is important to know and follow established site policies and procedures to ensure the site is maintained and functioning in a smooth and safe manner. Knowing what to do in case of a fire and knowing where the different areas of the bivouac/training site are located will ensure the weekend exercise runs as smoothly as possible.

INSTRUCTOR NOTES/REMARKS

N/A.

REFERENCES

A3-010 A-CR-CCP-121/PT-001, Cadets Canada. (2000). *Royal Canadian Army Cadet Reference Book*. Ottawa, ON: Cadets Canada.

- C3-003 (ISBN 1-896713-00-9) Tawrell, P. (1996). *Camping and Wilderness Survival: The Ultimate Outdoors Book*. Green Valley, Ontario: Paul Tawrell.
- C3-006 (ISBN 0-07-135437-9) Hall, A. (2001). *The Essential Backpacker: A Guide for the Foot Traveller*. Blacklick, OH: Ragged Mountain Press.
- C3-007 (ISBN 0-684-85909-2) Harvey, M.(1999). *The National Outdoor Leadership School's Wilderness Guide*. New York: Simon & Schuster.

THIS PAGE INTENTIONALLY LEFT BLANK



ROYAL CANADIAN AIR CADETS

LEVEL ONE

INSTRUCTIONAL GUIDE



SECTION 4

EO M190.04 – DISCUSS SURVIVAL PSYCHOLOGY

Total Time:

60 min

INTRODUCTION

PRE-LESSON INSTRUCTIONS

A complete list of resources needed for the instruction of this EO is located at Chapter 2 of the QSP. Specific uses for said stores are identified throughout the Instructional Guide, within the teaching point for which they are required.

Prior to instructing this lesson the instructor shall:

- review the lesson content, and become familiar with the material;
- prepare the case study material for the activity in TP3; and
- prepare the role-play material for the activity in TP4.

PRE-LESSON ASSIGNMENT

N/A.

APPROACH

The interactive lecture method was chosen as it allows the instructor to make a semi-formal presentation of the material where the cadets can participate by asking or responding to questions and commenting on the material. For this lesson, this method is most effective as it matches well the taxonomic level of the material and is age-appropriate by virtue of its participatory nature.

REVIEW

N/A.

OBJECTIVES

By the end of this lesson the cadet shall be expected to identify:

- the role of fear in a survival situation;
- the actions to be taken when lost, to include the STOP acronym;
- the survival pattern and how to employ it; and
- the seven enemies of survival and how to combat them.

IMPORTANCE

One of the most important requirements for someone in a survival situation is the ability to accept the reality of the situation and react appropriately. Knowing how to react in a survival situation will give an individual confidence to survive. The cadets should know what they would experience physically and emotionally if they were lost and in a survival situation. Knowing the procedure when lost and how to deal with fear will promote survival in the situation.

Teaching Point 1

Explain the Role of Fear in a Survival Situation

Time: 5 min

Method: Activity/Interactive Lecture



The following activity is designed to get the cadets thinking about fear. Ensure the following points that produce fear are discussed during the activity: death, being alone, animals/bugs, darkness, weakness, failure, discomfort, the unknown, and unidentified sounds.

ACTIVITY

Time: 5 min

OBJECTIVE

The objective of this activity is to have cadets think about things they could be afraid of in a survival situation.

RESOURCES

N/A.

ACTIVITY LAYOUT

1. As a whole group, brainstorm things cadets may be afraid of in a survival situation.
2. Discuss how equipment, knowledge, and task focus can help reduce fear.

SAFETY

N/A.

INSTRUCTOR GUIDELINES

Ensure all cadets participate in the discussion.

REACTIONS TO FEAR

Fear is a normal reaction when in a survival situation. Fear can aid or hinder individuals depending on their reaction to it. It can lead to hopelessness and decreased self-confidence as well as reducing the will to survive. Fear, however, can release adrenaline, giving greater strength and stamina, reducing the sensation of pain, giving the ability to think clearly and helping one to act purposefully. Accepting fear as a natural reaction to a threatening situation will lead to productive behaviour. Because of this, fear can greatly increase chances for survival.

DEALING WITH FEAR

The factors most commonly reported to help decrease or control fear are:

- having confidence in a leader, if in a group, or in one's self, if alone;
- having confidence in one's equipment; and
- concentrating on the job to be done.

Teaching Point 2

Explain the Actions to Take When Lost

Time: 10 min

Method: Activity/Interactive Lecture

THE "STOP" ACRONYM

Taking immediate action when lost in the wilderness is critical to dealing with fear. In such a situation, the STOP acronym should be employed.

STOP

When one becomes lost, stopping will prevent the person from possibly moving further away from the area a search crew may cover. It is also important to stop so one can think effectively. By stopping to think, one may avoid making errors due to hasty decisions.

THINK

It is critical to think about what actions should be taken once a person realizes they are lost. One should think of the danger and consequences of either staying put or moving on. One should think about the possible dangers that could occur. Analyzing the weather, terrain and available resources should also be taken into account when deciding on the actions to be taken.

OBSERVE

Conduct a self-analysis to identify possible symptoms of physical ailments such as fatigue, increased heart rate, or shivering. Also, look for psychological ailments such as extreme stress or fear. Observe surroundings for resources, weather potential, terrain, and possible landmarks that can provide information on one's current location.

PLAN

After thinking of and observing all aspects of the situation, plan a course of action that will best use the available resources.

CONFIRMATION OF TEACHING POINT 2

QUESTIONS

- Q1. What are the four main actions to take when lost in the wilderness?
- Q2. Why is it important to stop if you are lost?
- Q3. During the thinking portion of STOP, what are some important things to keep in mind?

ANTICIPATED ANSWERS

- A1. Stop, think, observe, plan.
- A2. So one can think effectively as well as avoid making errors due to otherwise hasty decisions.

- A3. To identify immediate and future dangers as well as weighing the pros and cons of staying put versus continuing on.

Teaching Point 3**Explain the Survival Pattern and How to Employ it in a Survival Situation**

Time: 15 min

Method: Interactive Lecture/Activity

GENERAL

The survival pattern is a procedure used in a survival situation. It is a way of prioritizing tasks.



The pattern is presented in a particular sequence during this lesson; however, the pattern can vary depending on the situation and changes in priority. For example, if you become lost while hiking with a group, the first procedure in the pattern should be to signal (blow your whistle) because there are people nearby.

FIRST AID

The most important thing to address in a survival situation is any injury that may have been sustained. Treating injuries can prevent conditions from worsening, and reduce pain. Treating injuries allows for more involvement in survival activities.

FIRE

Fire serves many purposes in a survival situation. It can provide warmth, boost morale, and provide a sense of security. It is a method for creating signals and can help purify water and cook food.

SHELTER

Shelter allows a person to be warm and dry by providing protection from the elements. Even if the current weather conditions are favourable, it is not always possible to know when and how the weather conditions may change. Therefore, building a shelter early is very important. It also provides the psychological comfort of having a home base.

SIGNALS

Signals should be constructed to attract search teams. Signals can take many different forms. Signal fires with heavy amounts of dark smoke are visible from a long distance away during the day or night. Other ground to air signals should be large and stand out from the surroundings, or be placed in nearby open areas. A mirror or other reflecting object is an excellent tool for signalling.

FOOD AND WATER

Survival without water will only last a few days. Lack of water can lead to mild dehydration, which can reduce the ability to concentrate. This in turn can be dangerous, as clear thinking is essential in a survival situation. Water from any ground source should be purified before drinking.

A person can live for weeks without food. Excessive hunger can cause confusion and lack of judgement. Prolonged starvation will result in loss of energy, loss of mental clarity, increased susceptibility to disease, difficulty maintaining body temperature, and eventually death. A balanced and varied diet can improve morale in a survival situation.

ACTIVITY

Time: 10 min

OBJECTIVE

The objective of this activity is to have cadets think about how to apply STOP and the survival pattern in a provided scenario.

RESOURCES

One copy of a survival scenario per group, found in Annex A (laminated, if possible).

ACTIVITY LAYOUT

1. The instructor will divide the cadets into two groups.
2. The instructor will give each group a survival scenario.
3. Cadets will be given five minutes to read the scenario and answer the questions provided.
4. Each group will share their scenario.

SAFETY

N/A.

INSTRUCTOR GUIDELINES

- Ensure all cadets participate in the scenario discussion.
- Provide coaching as necessary.

Teaching Point 4

Explain the Seven Enemies of Survival and How to Combat Them

Time: 15 min

Method: Interactive Lecture/Activity

GENERAL

Pain, cold, thirst, hunger, fatigue, boredom, and loneliness are enemies of survival. In a survival situation, these feelings are more severe and more dangerous than in normal situations. Having knowledge of these feelings and their effects can assist in overcoming and controlling them.

PAIN

Pain is nature's way of identifying problems. Pain can however, subside if one is preoccupied. Pain may go unnoticed if one's mind is occupied with plans of survival. Once a person gives into pain, it will weaken the drive to survive. A special effort should be made to keep one's hopes up and keep working.

COLD

Cold lowers the ability to think and will to complete necessary tasks for survival. Focusing on being cold can interfere with the goal of survival. Cold can numb both the mind and body. It can also lead to serious medical problems. Find ways to get and stay warm, like building a fire, getting dry, layering clothes, and keeping busy.

THIRST

Water is vital for survival. Dehydration can lead to serious medical problems, and can eventually be fatal. Even when thirst is not extreme, it can dull the mind. Drink regularly, and try to find sources of water.

HUNGER

Hunger is dangerous because it can lessen the ability for rational thought. Both thirst and hunger increase a person's susceptibility to the weakening effects of cold, pain and fear. Prolonged hunger can lead to serious medical problems and can eventually be fatal. Manage food supplies, set snares, fish, and collect edible plants.

FATIGUE

Even a moderate amount of fatigue can reduce mental ability. Fatigue can make people careless as it becomes increasingly easy to adopt the feeling of just not caring. This is one of the biggest dangers in survival. While fatigue can be caused by overexertion, it may also be caused by hopelessness, losing sight of goals, dissatisfaction, frustration or boredom. Fatigue may represent an escape from a situation that has become too difficult. Recognizing the dangers of a situation can provide the strength to go on. Watch exertion levels, set goals, and stay busy.

BOREDOM AND LONELINESS

Boredom and loneliness represent the final two enemies of survival. They are perhaps two of the toughest enemies of survival, mainly because they are unexpected. When nothing happens, when something is expected and does not happen, or when one must stay still, quiet, and alone, these feelings develop. They can cause discouragement and a lack of will to go on. Invent games, stay active, and create projects.

ACTIVITY

Time: 5 min

OBJECTIVE

The objective of this activity is to have cadets act out the seven enemies of survival.

RESOURCES

- Slips of paper with one of the seven enemies of survival on each.
- Container to draw the slips from (e.g. bag, hat, etc.).

ACTIVITY LAYOUT

1. Randomly select a cadet to draw the first slip.
2. The cadet will silently act out the enemy of survival shown on their slip.
3. The rest of the cadets will guess which enemy is being acted out.
4. The instructor will select another cadet, until all the enemies have been portrayed.

SAFETY

As the activity is being conducted, ensure the cadets are constantly aware of their surroundings so they do not trip, fall, etc.

INSTRUCTOR GUIDELINES

Ensure all cadets participate in the acting and/or the guessing.

END OF LESSON CONFIRMATION**QUESTIONS**

- Q1. What factors cause fear?
- Q2. What factors reduce fear?
- Q3. What does STOP stand for?
- Q4. What elements make up the survival pattern?
- Q5. What are the seven enemies of survival?

ANTICIPATED ANSWERS

- A1. Hopelessness and helplessness.
- A2. Confidence in your equipment, yourself (or your leader), and focusing on the tasks at hand.
- A3. Stop, Think, Observe, Plan.
- A4. First aid, shelter, fire, water, food.
- A5. Pain, cold, thirst, hunger, fatigue, boredom and loneliness.

CONCLUSION**HOMEWORK/READING/PRACTICE**

N/A.

METHOD OF EVALUATION

There is no formal assessment of this EO.

CLOSING STATEMENT

One of the most important requirements for someone in a survival situation is the ability to accept the reality of the situation and react appropriately. If cadets are able to react calmly to a survival situation and develop a sensible plan, they are more likely to experience success.

INSTRUCTOR NOTES/REMARKS

N/A.

REFERENCES

- A3-016 B-GA-217-001/PT-001, *Down but Not Out*. (ND). Ottawa, ON: National Defence.
- C3-005 Sierra Club, San Diego Chapter. *Wilderness Basics: The Complete Handbook for Hikers & Backpackers* (1999). Portland, Oregon: The Mountaineers Books.

THIS PAGE INTENTIONALLY LEFT BLANK



ROYAL CANADIAN AIR CADETS

LEVEL ONE

INSTRUCTIONAL GUIDE



SECTION 5

EO M190.05 – IDENTIFY TYPES OF SHELTERS

Total Time:	30 min
-------------	--------

INTRODUCTION

PRE-LESSON INSTRUCTIONS

A complete list of resources needed for the instruction of this EO is located at Chapter 2 of the QSP. Specific uses for said stores are identified throughout the Instructional Guide, within the teaching point for which they are required.

Prior to instructing this lesson the instructor shall:

- review the lesson content, and become familiar with the material;
- select two sites, as described in the activity section of TP1;
- survey the survival site to see if there are fallen trees or caves present to use as visual aids during the lesson;
- create an A-frame shelter and a lean-to shelter for demonstration purposes during the class;
- if the materials are available, erect an arctic bell tent, modular tent section and/or commercial tent for demonstration purposes during the class.

PRE-LESSON ASSIGNMENT

N/A.

APPROACH

The interactive lecture method was chosen as it allows the instructor to make a semi-formal presentation of the material where the cadets can participate by asking or responding to questions and commenting on the material. For this lesson, this method is most effective as it matches well the taxonomic level of the material and is age-appropriate by virtue of its participatory nature.

The small group activity was selected to allow for maximum participation in the learning process. It is an interactive way to illustrate and substantiate the lesson material in a concrete manner.

REVIEW

N/A.

OBJECTIVES

By the end of this lesson the cadet shall be expected to:

- describe factors in site selection;

- identify types of natural shelters;
- identify types of improvised shelters; and
- identify types of tentage/commercial shelters.

IMPORTANCE

In a survival situation, it is very important to be able to construct an effective shelter. A shelter will protect a person from weather, animals and insects. Shelters can also provide warmth, shade, and comfort. Furthermore, as previously learned, being able to identify various types of shelters is an important component of the survival pattern.

Teaching Point 1

Explain the Importance of Site Selection

Time: 10 min

Method: Interactive Lecture/Activity



Before presenting the information provided below, ask the cadets what they feel is important when selecting a site for a shelter. Do not confirm or correct their responses at this time. It is simply a lead off question to get them thinking.

LAND CONSIDERATIONS

Site selection should begin, if possible, before dark. The shelter should be built near a source of water, building materials (trees, boughs) and fuel. Specific land considerations include:

- the area must be large enough for the type of shelter planned;
- the area should not be at the bottom of a hill because of possible water runoff;
- the area should be relatively flat, but slightly sloped to allow drainage; and
- dry river gullies should be avoided, because of possible water collection in the gully.

WATER CONSIDERATIONS

Water plays an important role in site selection. Specific water considerations include avoid building too close to:

- water, to avoid insects; and
- the drinking water source, to prevent contamination.

ANIMAL AND INSECT CONSIDERATIONS

Animals and insects can also cause problems to your site. Specific animal and insect considerations are:

- avoid setting up a shelter where there are animal trails or standing water;
- fast flowing streams will have fewer insects than still water; and
- avoid areas infested with ants or bees.

OTHER CONSIDERATIONS

Other considerations to keep in mind when selecting a site include:

- there should be an open area nearby to construct signals;

- the entrance of the shelter should face the sun to add warmth and increase morale;
- avoid collecting thick wood for creating fires because it is harder to dry;
- try to find a natural windbreak or a place that is away from strong wind currents;
- avoid swampy terrain; and
- if a fire is to be built, it should be located at the opening of the shelter, and it should be done at a distance.

ACTIVITY

Time: 5 min

OBJECTIVE

The objective of this activity is to allow cadets to identify a good site for shelter construction.

RESOURCES

N/A.

ACTIVITY LAYOUT

- Show the cadets two sites; one will be a good site and the other a poor site.
- Ask the cadets to choose the best site and to provide information as to why they made that choice.
- After the cadets have properly identified the good site, have them identify faults for shelter construction in the poor site.

SAFETY

As the activity is being conducted, ensure the cadets are constantly aware of their surroundings to avoid injury.

INSTRUCTOR GUIDELINES

- Before teaching this class, the instructor is to have selected two sites to show the cadets in this activity.
- The instructor must ensure that one site is a good site for constructing a shelter (e.g. follows the important factors listed above).
- The instructor must also ensure that the other site selection has a number of areas that can easily be identified as concerns by the cadets.

CONFIRMATION OF TEACHING POINT 1

QUESTIONS

- Q1. Why should the site not be located at the bottom of a hill?
- Q2. Why should the site not be built too close to the drinking water source?
- Q3. Why should there be an open area near the shelter when selecting the site?

ANTICIPATED ANSWERS

- A1. To avoid possible water runoff.

- A2. To avoid contamination of the drinking water source.
- A3. To maintain an area to construct signals.

Teaching Point 2

Describe Natural Shelters

Time: 5 min

Method: Interactive Lecture



Before conducting the lesson, the instructor should find examples of each type of natural shelter on the training site. Also, if possible, conduct this teaching point by the shelters themselves. The instructor should have pictures of the shelters to show the class, in case one or both of the natural shelters cannot be found in the area.

NATURAL SHELTERS

Natural shelters are effective to use in situations where you have limited resources. Different types of natural shelters can be used for short-term and/or long-term shelters.

CAVES

Caves may serve as long-term shelters and do not take energy to build. They can also be great waterproof shelters. The entrance should be sealed off with items such as rocks, logs, or wattle (boughs and broken branches). When building a fire, ensure to place it at the back of the cave so smoke will go out the opening. If the fire is placed by the opening, the smoke will blow back into the cave.

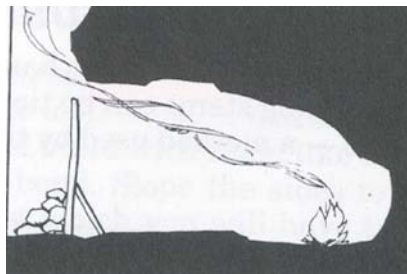

The SAS Survival Handbook, John Wiseman, 1999

Figure 15-5-1 Cave Shelter

FALLEN TREE

A fallen tree can make a great temporary shelter. When using a fallen tree as a shelter, ensure that the tree is stable and will not fall further. Also, be aware of other falling trees in the area. Coniferous trees with pine branches are best because of their dense branch structure. The branches can be woven for protection.



The SAS Survival Handbook, John Wiseman, 1999

Figure 15-5-2 Fallen Tree Shelter

CONFIRMATION OF TEACHING POINT 2

QUESTIONS

- Q1. Name two types of natural shelters.
- Q2. When lighting a fire inside a cave, what should be kept in mind?

ANTICIPATED ANSWERS

- A1. Cave and fallen trees.
- A2. The fire should be lit towards the back of the cave so that smoke will go out the opening.

Teaching Point 3

Describe Improvised Shelters

Time: 5 min

Method: Interactive Lecture



Prior to instructing the lesson, the instructor must ensure there is an A-frame shelter and a lean-to shelter on site to use as visual aids to the class. Directions as to how to properly set up the shelters listed below are provided in Annex C.

IMPROVISED SHELTERS

Improvised shelters are used in situations where immediate protection from the element is required. They are shelters that can be constructed quickly from various materials. The A-frame and lean-to are two types of improvised shelters that are very effective in protecting against the elements. A type of A-frame shelter is the hootchie style shelter.

A-FRAME SHELTER

An A-frame shelter is a simple shelter that can be constructed with a ground sheet or a waterproof poncho. The ground sheet or poncho can be tied to two wood stakes with twine or roots found on the site. The construction of this shelter will be further detailed in an upcoming lesson.

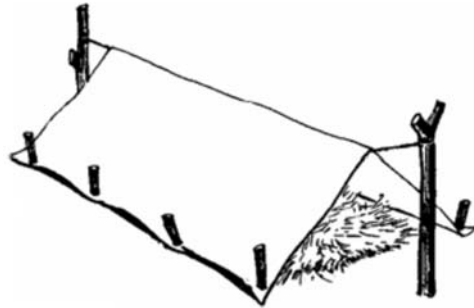

The SAS Survival Handbook, John Wiseman, 1999

Figure 15-5-3 A-frame Shelter

LEAN-TO SHELTER

A lean-to shelter is constructed by using a horizontal crosspiece between two trees, with a panel of boughs or saplings used as a roof.

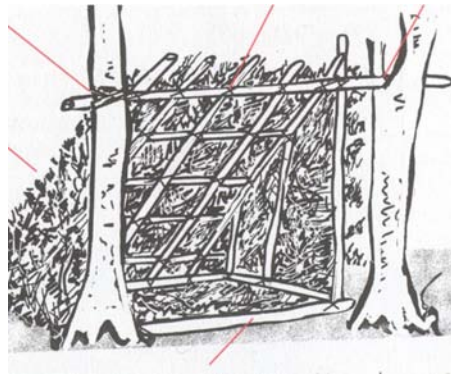

Camping and Survival Wilderness, Paul Tawrell, 2002

Figure 15-5-4 Lean-to Shelter

CONFIRMATION OF TEACHING POINT 3

QUESTIONS

- Q1. When are improvised shelters important to use?
- Q2. What materials are needed to construct an A-frame shelter?
- Q3. What are the main components of a lean-to shelter?

ANTICIPATED ANSWERS

- A1. When permanent shelters are not available. In situations where immediate protection from the elements are required.
- A2. A ground sheet/waterproof poncho and twine/roots.
- A3. A lean-to shelter is composed of a horizontal crosspiece between two trees, with a panel of boughs or saplings used as a roof.

Teaching Point 4**Describe Tentage**

Time: 5 min

Method: Interactive Lecture

TENTAGE

Tentage is a permanent type of shelter that is useful for coping with the elements.



The instructor is encouraged to emphasize certain types of tentage, based on what types of tents are available to the squadron during this exercise. When setting up the types of tentage mentioned below to use as training aids, the instructor is encouraged to refer to Annex C for proper directions.

ARCTIC TENT

An arctic tent is a tent that can provide adequate shelter for up to 10 people. It is composed of a center pole, which goes through the top of the tent. The tent is then pegged down on all corners and tightened to provide optimal space inside.

MODULAR TENT

Modular tentage is often used as a sleeping or classroom setting for a large number of people. It is also effective in providing shade during hot days. It is erected in sections by using a combination of metal frames and canvas coverings.

COMMERCIAL TENTS

Commercial tents are a third type of tentage that can be used for sleeping quarters. Commercial tents vary in shape and size and are constructed to accommodate anywhere between 1 and 10 people.

CONFIRMATION OF TEACHING POINT 4

QUESTIONS

- Q1. For how many people can an arctic shelter provide shelter?
- Q2. What are the uses of modular tents?

ANTICIPATED ANSWERS

- A1. It is composed of a center pole, which is erected through a hole in the top of the tent. The tent is then pegged down on all corners and tightened to provide optimal space inside.
- A2. Modular tentage can be used as sleeping quarters, a classroom setting, and can also provide shade during hot days.

END OF LESSON CONFIRMATION

All cadets will be required to assist in the construction of various shelters throughout the weekend. Since this class is a lead up to the construction of an A-frame style shelter, no formal end of lesson confirmation activity will be conducted. However, the instructor should pose questions to the group to confirm that the information presented in this EO was understood.

QUESTIONS

- Q1. What are the various types of factors that need to be remembered when selecting a site?
- Q2. When are natural shelters effective to use?
- Q3. What are two types of improvised shelters?
- Q4. What are three types of tentage?

ANTICIPATED ANSWERS

- A1. Land considerations, water considerations, animal and insect considerations and other considerations.
- A2. In a situation where limited resources are available.
- A3. A-frame shelter and lean-to shelter.
- A4. Arctic tents, modular tents, and commercial tents.

CONCLUSION

HOMEWORK/READING/PRACTICE

N/A.

METHOD OF EVALUATION

There is no formal assessment of this EO. Instructors will confirm cadets' comprehension of the material while constructing a hootchie style shelter in EO M190.06 (Section 6).

CLOSING STATEMENT

Constructing shelter is a key component of a successful survival pattern. In such a situation, protection against the elements and against wildlife or insects is extremely important. Knowing how to properly select a site, as well as how to construct a shelter effectively will assist someone significantly in such a scenario.

INSTRUCTOR NOTES/REMARKS

N/A.

REFERENCES

- A3-009 A-CR-CCP-107/PT-002 (1979). *Royal Canadian Army Cadet Winter Adventure Training Manual*, Ottawa, ON: Cadets Canada.
- A3-012 B-GG-302-002/FP-001 (Old)/B-GL-321-008/FP-001 (New), *Specific Operations*, Volume 2, Part 1, – *Basic Cold Weather Training*: Canadian Forces.
- C3-002 (ISBN 0-00-653140-7) Wiseman, J. (1999). *The SAS Survival Handbook*. Hammersmith, London: HarperCollins Publishers.
- C3-003 (ISBN 1-896713-00-9) Tawrell, P. (2002). *Camping & Wilderness Survival: The Ultimate Outdoors Book*. Lebanon, New Hampshire: Paul Tawrell.
- C3-004 (ISBN 1-85227-866-8) Davies, B. (1999). *SAS Encyclopedia of Survival*. Hammersmith, London: Virgin Publications.



ROYAL CANADIAN AIR CADETS

LEVEL ONE

INSTRUCTIONAL GUIDE



SECTION 6

EO M190.06 – CONSTRUCT A HOOTCHIE STYLE SHELTER

Total Time: 90 min

INTRODUCTION

PRE-LESSON INSTRUCTIONS

A complete list of resources needed for the instruction of this EO is located at Chapter 2 of the QSP. Specific uses for said stores are identified throughout the Instructional Guide, within the teaching point for which they are required.

Prior to instructing this lesson the instructor is required to:

- review the lesson content, and become familiar with the material;
- prepare a suitable instructional area;
- prepare all materials required for the construction of a hootchie-style shelter for each group of cadets; and
- prepare an example hootchie style shelter.

PRE-LESSON ASSIGNMENT

N/A.

APPROACH

The demonstration and performance method was chosen due to the practical nature of the subject matter. These methods provide the instructor the opportunity to introduce the subject matter, demonstrate procedures and observe the cadets practicing and performing the skill. The demonstration and performance methods must always be used when the taxonomic level of the material requires a performance of a skill. These methods are highly developmentally appropriate for young cadets.

REVIEW

The pertinent review for this lesson will include site selection factors EO M190.04 (Section 4), including:

- land considerations;
- water considerations;
- animal and insect considerations; and
- other considerations.

OBJECTIVES

By the end of this lesson the cadet shall be expected to construct a hootchie style shelter.

IMPORTANCE

In a survival situation, it is very important to be able to construct an effective shelter. A shelter will protect a person from weather, animals and insects. Shelters can also provide warmth, shade and comfort. The hootchie style shelter provides an effective shelter for squadron aircrew survival exercises.

Teaching Point 1

Explain and Demonstrate the Correct Procedure for Constructing a Hootchie Style Shelter

Time: 25 min

Method: Demonstration



The following teaching point should be delivered as the instructor is constructing a hootchie style shelter. A demonstration should occur for each step. A shelter may also be built prior to the lesson for illustration purposes.

OBTAIN THE APPROPRIATE SUPPLIES

In order to effectively build a hootchie style shelter, the following supplies will be needed:

- Two military style ground sheets that properly zip together (these can also be called half shelters or utility sheets).
- A generous length of twine or thin rope.
- Several pegs or small twigs.
- Spade or small shovel.
- Knife or scissors.



Cadets Canada Photo, 2006

Figure 15-6-1 Two Military Style Ground Sheets



Cadets Canada Photo, 2006

Figure 15-6-2 Appropriate Supplies

SELECTING A SITE

Principles of selecting a site reviewed in the introduction portion of the lesson should be applied when selecting a site to construct the hootchie. In addition to these principles, the site shall include:

- Two trees spread approximately 10 feet apart (or the length of the ground sheets allowing for approximately two feet for the entrance).

- Ground that is suitable for pegging.
- Clear of wet leaves and other foliage.

CHECKING MATERIAL

Prior to commencing construction, all materials should be checked for fatigue and wear, especially the two ground sheets. They should not have holes that would allow rain and other objects into the completed shelter. Also ensure on either end of the ground sheets that the two zippers match up and will form a sufficient bond. Grommets on each ground sheet should be in good repair so they can hold pegs effectively.



Cadets Canada Photo, 2006

Figure 15-6-3 Grommet

The twine used should be strong enough to hold the two ground sheets up and allow enough give for the fatigue that will be experienced when cadets get in and out of the shelter.

ZIPPING THE GROUND SHEETS

The two ground sheets should be zipped together to form a sufficient bond. Ensure that the two zippers are the same length and are not worn out because the bond may be compromised.



Cadets Canada Photo, 2006

Figure 15-6-4 Zipping Ground Sheets



Cadets Canada Photo, 2006

Figure 15-6-5 Two Ground Sheets Zipped Together

TYING THE SHELTER TO TREES

Tie each end of the zipped together ground sheets to the two trees by passing the twine through the grommets located at each end of the zipper. A knot that is reliable and will provide stability shall be used. The shelter should be tied as high as the waist of the tallest occupant.



Cadets Canada Photo, 2006

Figure 15-6-6 Tying Shelter to a Tree

This height will allow enough head room when the shelter is complete. The two ground sheets should be pulled as tight as possible between the two trees. This tightness will prevent rain from collecting and will stop the shelter from sagging after extended use. When tying the shelter, ensure that the flap at the peak of the shelter covers the zipper. Make certain there is enough room on one end for an entrance and exit.



Cadets Canada Photo, 2006

Figure 15-6-7 Shelter Tied to Two Trees

PEGGING

Using an appropriate length of string, pull the string through the grommets that run along the bottom of the ground sheets. Tie the string together to form a loop. Using these loops, tightly pull each corner of the ground sheets out from the centre and peg them using small twigs.



Cadets Canada Photo, 2006

Figure 15-6-8 Pulling Pegs Tight



Cadets Canada Photo, 2006

Figure 15-6-9 Pegged Grommet

Leave the edge of the ground sheet about 5 centimetres above the ground for ventilation.



Cadets Canada Photo, 2006

Figure 15-6-10 Shelter 5 Centimetres Above the Ground

Any objects that will secure each corner of the ground sheets 5 centimetres above the ground will be sufficient to use as pegs. After the corners are pegged, peg the remaining grommets in between the two corners on each side. When each side of the shelter is pegged, it should result in a flush, tight surface with no wrinkles. This tight surface will allow for efficient runoff of rain.



Cadets Canada Photo, 2006

Figure 15-6-11 Flush, Tight Surface

Ensure that the flaps for the doors are tied together prior to pegging. If the doors are not tied, they may not tie together properly when the shelter is tightly pegged.



Cadets Canada Photo, 2006

Figure 15-6-12 Doors Tied Together

Two grommets are located down the centre of each ground sheet. Twine can be used to tie these grommets to surrounding trees or pegged into the ground to create more space in the shelter.

DIGGING TRENCHES

When all of the previous steps have been completed, dig small trenches 10 centimetres away from the sides of the shelter to allow for effective drainage of rainwater. Trenches should be approximately 10 centimetres in width and 5 to 10 centimetres deep. When the shelter is complete, dry grass or hay can be used as bedding.



Cadets Canada Photo, 2006

Figure 15-6-13 Completed Hootchie Style Shelter

ACTIVITY

Time: 60 min

OBJECTIVE

To allow cadets to apply the skills learned in TP1. They will construct a hootchie style shelter.

RESOURCES

The following resources will be required for each group of cadets:

- Two ground sheets that properly zip together.
- A generous length of twine or thin rope.
- Several pegs or small twigs.
- Spade or small shovel.
- Knife or scissors.
- Flagging tape.

ACTIVITY LAYOUT

- Divide cadets into groups of two. Each group member should be of the same gender.
- Direct cadets to find a suitable site to build a hootchie style shelter based on the principles learned in TP1.
- Issue required resources to each group of cadets.
- Direct each group to construct a hootchie style shelter in their site based on the steps learned in TP1.

SAFETY

Remind cadets to be careful when using knives or any device used to cut the twine. Twine used to hold the shelter up should be marked with flagging tape so it may be easily seen.

INSTRUCTOR GUIDELINES

- Ensure effective supervision during this activity. If available, other qualified instructors can be used to assist cadets in the construction of the shelters.
- Check that the site selected is appropriate before issuing the supplies.
- Each shelter should be checked when complete for deficiencies that will result in the shelter not being effective (allow in rainwater, collapse, etc.).
- This activity is best completed during an survival exercise when cadets are required to build shelters to sleep in.

CONFIRMATION OF TEACHING POINT 1

QUESTIONS

- Q1. What supplies are required to construct a hootchie style shelter?
- Q2. How high should the two ground sheets be tied to the trees?

Q3. How high should the edge of the ground sheets be pegged above the ground?

ANTICIPATED ANSWERS

- A1. Two ground sheets that properly zip together, a generous length of twine/thin rope, pegs or small twigs, a spade or small shovel, and a knife or scissors.
- A2. As high as the waist of the tallest shelter occupant.
- A3. Approximately 5 centimetres.

END OF LESSON CONFIRMATION

Each shelter shall be checked by the instructor to ensure that all of the steps have been followed and that the shelter is sound.

CONCLUSION

HOMEWORK/READING/PRACTICE

N/A.

METHOD OF EVALUATION

There is no formal assessment of this lesson.

CLOSING STATEMENT

The cadets have had the opportunity to construct a hootchie style shelter. In a survival situation, it is very important to be able to construct an effective shelter. A shelter will protect a person from the weather, animals and insects. Shelters can also provide warmth, shade and comfort. The hootchie style shelter provides an effective shelter for squadron aircrew survival exercises.

INSTRUCTOR NOTES/REMARKS

N/A.

REFERENCES

- C3-002 (ISBN 0-00-653140-7) Wiseman, J. (1986). *The SAS Survival Handbook*. London: Harper Collins Publishers.
- C3-003 (ISBN 1-896713-00-9) Tawell, P. (1996). *Camping and Wilderness Survival: The Ultimate Outdoors Book*. Green Valley, ON: Fifteenth Printing.

THIS PAGE INTENTIONALLY LEFT BLANK



ROYAL CANADIAN AIR CADETS

LEVEL ONE

INSTRUCTIONAL GUIDE



SECTION 7

EO M190.07 – LIGHT, MAINTAIN AND EXTINGUISH A FIRE

Total Time:	90 min
-------------	--------

INTRODUCTION

PRE-LESSON INSTRUCTIONS

A complete list of resources needed for the instruction of this EO is located at Chapter 2 of the QSP. Specific uses for said stores are identified throughout the Instructional Guide, within the teaching point for which they are required.

Prior to instructing this lesson the instructor shall:

- review the lesson content, and become familiar with the material;
- prepare an example fire ready to be lit; and
- prepare examples of types of fires.

PRE-LESSON ASSIGNMENT

N/A.

APPROACH

The interactive lecture method was chosen as it allows the instructor to make a semi-formal presentation of the material where the cadets can participate by asking or responding to questions and commenting on the material. For this lesson, this method is most effective as it matches well the taxonomic level of the material and is age-appropriate by virtue of its participatory nature.

The demonstration and performance methods were chosen due to the practical nature of the subject matter. These methods provide the instructor the opportunity to introduce the subject matter, demonstrate procedures and observe the cadets practicing and performing the skill. The demonstration and performance methods must always be used when the taxonomic level of the material requires a performance of a skill. These methods are highly developmentally appropriate for young cadets.

REVIEW

N/A.

OBJECTIVES

By the end of this lesson the cadet shall be expected to apply fire safety principles as well as light, maintain and extinguish a fire.

IMPORTANCE

Safety is a key concern when dealing with fire. Cadets must understand and apply principles of fire safety before they begin the steps in lighting. Fire is also the second step in the survival pattern and may be the difference between living and dying while in a survival situation.

Teaching Point 1

Identify Principles of Fire Safety

Time: 5 min

Method: Interactive Lecture

OBEDY FOREST FIRE DANGER RATING SYSTEM

In cooperation with various fire management agencies, the Canadian Forest Service manages the Forest Fire Danger Rating System. The system uses weather, fuel and topographic data to rate the potential for forest fire ignition and to predict forest fire behaviour. The Forest Fire Danger Rating System must be at a suitable level prior to starting a fire. Never light a fire when the rating is high, very high or extreme. The slightest spark could cause a forest fire.



Tripod Photo Website, <http://www.members.tripod.com>

Figure 15-7-1 Forest Fire Danger Rating System

AVOID STRONG WINDS

If wind speed is high, the fire will be at risk of spreading if not properly managed. Strong winds can carry sparks away from the fire pit and start an unwanted fire. The fire should be placed in a location where it is effectively sheltered from strong winds.

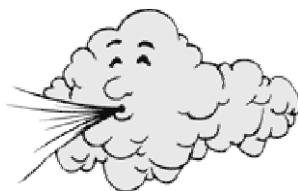

Impression Photo Website, <http://www.impression5.org>

Figure 15-7-2 Strong Wind

SIZE OF FIRE

The fire shall be a suitable size so control can be maintained at all times. Never allow a fire to get larger than four feet wide and three feet high. Fires that are too large can burn out of control, and cause forest fires or personal injury. If a fire becomes too large, stop adding fuel and let the fire cool down.

CONFIRMATION OF TEACHING POINT 1

QUESTIONS

- Q1. What is the Forest Fire Danger Rating System?
- Q2. What might happen if a fire is placed in an area with strong winds?
- Q3. Why must one maintain a suitable size fire?

ANTICIPATED ANSWERS

- A1. The Forest Fire Danger Rating System uses weather, fuel and topographic data to rate the potential for forest fire ignition and to predict forest fire behaviour.
- A2. It is at risk of spreading.
- A3. Fires that are too large can burn out of control, and cause forest fires or personal injury.

Teaching Point 2

Explain, Demonstrate and Have Cadets Determine the Appropriate Site for a Fire

Time: 15 min

Method: Demonstration and Performance

SITE LOCATION

- Avoid windy areas because the fire can flare up and burn out of control. A reflector or a windbreak can be built out of green wood or rocks. The advantage of a reflector is that it concentrates the heat in the desired direction. Areas near water tend to have higher winds.
- Clear the ground of all inflammable material before starting the fire. The material should be raked towards the centre of the site where the dead leaves, pine needles and other debris can be burned.
- Do not build the fire against an old log or tree trunk. The log may smoulder and catch fire in a breeze.
- Do not build the fire below the boughs of a tree. The boughs will dry from the heat and may catch fire.
- The fire should be a suitable distance from any shelter so the smoke will not get into it when the wind changes direction.

SITE LAYOUT

- Surround the fire with dry rocks. They will help contain the fire so it may be properly maintained. Do not use rocks that have been submerged in water. Water expands as it is heated and may cause the rocks to explode. If rocks are unavailable, dig a pit approximately one half foot deep and four feet wide. This pit will help prevent unwanted spreading of the fire.
- Appropriate firefighting equipment shall be placed in close proximity to the fire.



The instructor should deliver this teaching point around a properly constructed fire site. The constructed fire site should be used as a training aid when each principle is presented.

ACTIVITY

Time: 11 min

OBJECTIVE

To allow the cadet to practically apply the principles learned by constructing an effective fire site.

RESOURCES

- Suitable location for a fire site.
- Rake.
- Shovel.
- Rocks.
- Fire extinguisher.
- Gerry can.
- Water pack.
- Water.
- Bucket of sand.
- Wire broom.
- Axe.
- Fire bell.

ACTIVITY LAYOUT

- This activity will be the first of two activities conducted throughout the lesson that will result in the cadet building, lighting and extinguishing a fire.
- Divide cadets into small groups (size will vary depending on how many cadets are undergoing training: maximum number of cadets in a group should be six).
- Direct cadets to find an appropriate location for a fire by applying the principles they learned in TP2.
- Once an appropriate location has been chosen, provide cadets with a rake and shovel. Direct them to clear the ground and dig a pit that will accommodate their fire.
- Direct cadets to gather dry rocks and surround their fire pit.

SAFETY

Ensure cadets are mindful of the equipment being used.

INSTRUCTOR GUIDELINES

- Supervise groups effectively throughout the activity.
- Ensure each group chooses an appropriate location prior to allowing cadets to proceed with digging the pit.
- Ensure each group effectively rakes the fire site and digs a pit no larger than one half foot deep and four feet wide.
- Ensure rocks are of a suitable size and have not been submerged in water.
- Ensure there is sufficient fire fighting equipment to conduct this activity.



After the cadets have completed the activity they should return to the original fire site for the next portion of the lesson.

CONFIRMATION OF TEACHING POINT 2

QUESTIONS

- Q1. Why is it unwise to build a fire near an old log or a tree trunk?
- Q2. Why must the rocks that surround the fire not be submerged in water?
- Q3. What equipment should be in close proximity to the fire site?

ANTICIPATED ANSWER

- A1. It may smoulder and catch fire.
- A2. Water expands when heated and the rock may explode.
- A3. Firefighting equipment.

Teaching Point 3

Identify the Required Elements of a Fire

Time: 5 min

Method: Interactive Lecture

ELEMENTS OF A FIRE

The three required elements for a fire include **oxygen, spark/heat and fuel**.



BT Photo Website, <http://www.btinternet.com>

Figure 15-7-3 Fire Triangle

Oxygen is required for a fire to stay lit. A spark is required to initially start the fire. The heat produced by the embers keeps the fire going. Fuel is anything that burns, such as wood.

If any one of the elements is removed, the fire will extinguish. When lighting a fire, always ensure adequate ventilation, enough fuel and a hot enough source to ignite the fuel.

	<p>The instructor shall provide a demonstration that proves oxygen, heat/spark and fuel are all needed to start a fire and keep it lit.</p>
	<p>The instructor will require a candle, a match and a large water glass. Explain that without the match (spark) and the candle (fuel), the fire cannot be lit. The instructor shall light the candle and place the empty water glass over the candle to prevent air (oxygen) from reaching it. The flame will extinguish.</p>

CONFIRMATION OF TEACHING POINT 3

QUESTIONS

- Q1. What are the three required elements of a fire?
- Q2. If one element is removed, what happens to the fire?

ANTICIPATED ANSWERS

- A1. Oxygen, spark/heat and fuel.
- A2. The fire will go out.

Teaching Point 4

Describe Types of Fires

Time: 15 min

Method: Interactive Lecture

WARMTH AND COMFORT FIRES

Warmth and comfort fires can help to conserve body heat and save needed calories. These fires can be helpful in keeping away wild animals and insects. Warmth and comfort fires are the most economical. They consume little fuel and burn slowly.

SIGNAL FIRES

Signal fires should produce heavy black smoke to attract potential rescuers. This black smoke can be generated by the addition of green branches, rubber, plastic or heavy oil to an already well-established fire.

COOKING FIRES

Cooking fires can be set flat on the ground. They can also be constructed in a pit if there is heavy wind or the surrounding ground contains a fire hazard. Cooking fires shall be a moderate size or the food will burn. The hot coals can be used to start a warmth and comfort fire to heat the camping area when cooking is finished.

	<p>Examples of these fires may be built to use as training aids.</p>
---	--

CONFIRMATION OF TEACHING POINT 4

QUESTIONS

- Q1. What are two advantages of a warmth and comfort fire?
- Q2. What are some items that can be added to a fire to produce thick black smoke?
- Q3. Which fire is the most economical?

ANTICIPATED ANSWERS

- A1. They can help conserve body heat, help save needed calories, keep wild animals and insects away, and they are the most economical.
- A2. Green branches, rubber, plastic or heavy oil.
- A3. Warmth and comfort fire.

Teaching Point 5

Explain, Demonstrate and Have Cadets Practice Lighting, Maintaining and Extinguishing Fires.

Time: 45 min

Method: Demonstration and Performance

LIGHTING A FIRE

Tinder. Tinder is any kind of material that a minimum amount of heat will ignite. Good tinder needs only a spark to set it ablaze. Birch bark, dry grass, fine wood shavings, bird down, waxed paper and cotton fluff from clothing all make good tinder. Tinder must be dry. It is a good idea to carry tinder in a waterproof container.

METHODS FOR OBTAINING A SPARK

Matches. Matches are the easiest way to start a fire. They produce a flame instantly when struck against a striking pad. The biggest problem with matches is that in wind or wet conditions they may not be useful. They will not ignite if the striking pad becomes worn or wet. The matches should be packed in waterproof containers so that they cannot rub or rattle together and accidentally ignite. Non-safety, strike anywhere matches are the most effective in a survival situation.

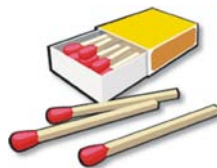

Clipart Website, <http://www.hasslefreeclipart.com>

Figure 15-7-4 Matches

Flint and Steel. Flint and steel is the best method of lighting a fire if matches are unavailable. If the flint is struck vigorously with a piece of steel, it will produce hot sparks that will ignite the fire. The flint should be struck downward so the sparks will hit the centre of the tinder. Even if the flint is wet, it will still produce a spark.

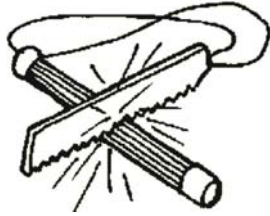

Clipart Website, <http://www.hasslefreeclipart.com>

Figure 15-7-5 Flint and Steel

Magnifying Glass. Magnifying glasses focus strong direct sunlight to produce enough heat to ignite a fire. The light from the sun should be directed onto the tinder. The obvious disadvantage to the magnifying glass is that if the sun is not out, it will not produce a spark.

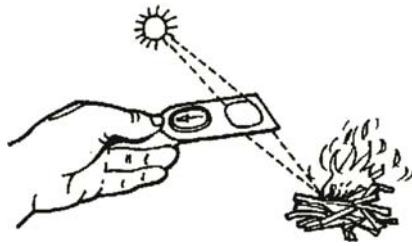

Clipart Website, <http://www.hasslefreeclipart.com>

Figure 15-7-6 Magnifying Glass

Battery and Steel Wool. Strands of steel wool can be attached to the terminals of a car battery to produce enough spark to start a fire. When the two strands of steel wool are brought close together, a spark will jump between them.



The SAS Survival Handbook, John Wiseman, 1986

Figure 15-7-7 Battery and Steel Wool



The instructor can use a nine-volt battery to demonstrate this method for obtaining a spark.

KINDLING

Kindling is the wood used to raise flames from the tinder so larger less combustible materials can be burned. The best kindling consists of small, dry twigs and small pieces of soft woods. Do not collect kindling straight from the earth because it is usually damp. It should be gathered from standing deadwood.

FUEL

Fuel is anything that will burn in the fire. Dry wood from standing trees should be used to get the fire going. Once the fire is established, greener and damp wood can be used. Hard woods include hickory, beech and oak. These hard woods burn well, give off heat, and last a long time as hot coals. The fire can be maintained for a long period of time using hard woods. Soft woods burn very quickly and give off sparks. They can be used when lighting the fire. These soft woods include cedar, alder, hemlock, spruce, pine, chestnut and willow. After the fire is steadily burning, add fuel that is three to four times the size of the kindling.

VENTILATION

Ventilation allows the needed oxygen to be supplied to the fire. The more oxygen introduced, the brighter the fire. The ideal amount of ventilation will result in a steady burn while only using a moderate amount of fuel. The fire will suffocate if there is too much fuel.

MAINTAINING A FIRE

A fire should never be left unattended. It takes only seconds for a fire to begin burning out of control. Immediately after a fire has been started, it requires a modest amount of wood to build up heat. The fire requires very little wood to keep it burning once a good amount of heat is built-up.

EXTINGUISHING A FIRE

Water is the easiest way to put out a fire. Water should be dumped on the fire until it results in no heat emanating from the centre. Ensure that all of the sparks are out prior to decamping by smothering it completely with wet earth or sand.

ACTIVITY

Time: 30 min

OBJECTIVE

To allow the cadet to practically apply the principles learned in TP5 by constructing, lighting, maintaining and extinguishing a fire.

RESOURCES

- Matches.
- Flint and steel.
- Battery and steel wool.
- Magnifying glass.
- Tinder.
- Kindling.
- Fuel.
- Fire site.
- Rake.
- Shovel.

- Firefighting equipment.
- Water.

ACTIVITY LAYOUT

- This activity will be the last of two activities that will result in the cadet building, lighting and extinguishing a fire.
- Divide cadets into the same groups that were used for building the fire site.
- Direct cadets to build a warmth and comfort style fire in their fire site.
- Once the fire has been built, cadets shall light the fires and effectively extinguish them.

SAFETY

Ensure firefighting equipment is nearby each fire site.

INSTRUCTOR GUIDELINES

- Ensure cadets construct the fire using all of the elements identified during the lesson (tinder, kindling and appropriate fuel).
- Ensure the fire is started with one of the methods explained in the lesson. Start with matches and use other methods if time permits.
- Ensure close supervision during the lighting and extinguishing phases.
- Ensure that all of the fires are properly extinguished prior to the end of the activity.
- Ensure the Forest Fire Danger Rating System is at an appropriate level for starting fires.

CONFIRMATION OF TEACHING POINT 5

QUESTIONS

- Q1. What is fuel?
- Q2. What does kindling do?
- Q3. Name two of the four methods of obtaining a spark mentioned in this lesson.

ANTICIPATED ANSWERS

- A1. Fuel is anything that burns (wood, gasoline, etc.).
- A2. Kindling is the wood used to raise the flames from the tinder so that larger less combustible materials can be burned.
- A3. Matches, flint and steel, magnifying glass, battery and steel wool.

END OF LESSON CONFIRMATION

Each cadet shall demonstrate that they are capable of lighting a fire using one of the methods discussed in the lesson, maintaining the fire and effectively extinguishing the fire. The principles of fire safety shall be noticeably practiced while lighting, maintaining and extinguishing the fire.

CONCLUSION

HOMEWORK/READING/PRACTICE

N/A.

METHOD OF EVALUATION

There is no formal assessment of this lesson.

CLOSING STATEMENT

Safety is a key concern when dealing with fire. Cadets must understand and apply principles of fire safety before they begin the steps in lighting. Fire is also the second step in the survival pattern and may be the difference between living and dying while in a survival situation.

INSTRUCTOR NOTES/REMARKS

N/A.

REFERENCES

- C3-002 (ISBN 0-00-653140-7) Wiseman, J. (1986). *The SAS Survival Handbook*. London: Harper Collins Publishers.
- C3-003 (ISBN 1-896713-00-9) Tawell, P. (1996). *Camping and Wilderness Survival: The Ultimate Outdoors Book*. Green Valley, ON: Fifteenth Printing.

THIS PAGE INTENTIONALLY LEFT BLANK



ROYAL CANADIAN AIR CADETS

LEVEL ONE

INSTRUCTIONAL GUIDE



SECTION 8

EO C190.02 – IDENTIFY ENVIRONMENTAL INJURIES

Total Time:	30 min
-------------	--------

INTRODUCTION

PRE-LESSON INSTRUCTIONS

A complete list of resources needed for the instruction of this EO is located at Chapter 2 of the QSP. Specific uses for said stored are identified throughout the Instructional Guide, within the teaching point for which they are required.

Prior to instructing this lesson the instructor shall:

- review the lesson content, and become familiar with the material; and
- prepare slips of paper for the end of lesson confirmation.

PRE-LESSON ASSIGNMENT

N/A.

APPROACH

The interactive lecture method was chosen as it allows the instructor to make a semi-formal presentation of the material where the cadets can participate by asking or responding to questions and commenting on the material. For this lesson, this method is most effective as it matches well the taxonomic level of the material and is age-appropriate by virtue of its participatory nature.

REVIEW

N/A.

OBJECTIVES

By the end of this lesson the cadet shall be able to identify environmental injuries.

IMPORTANCE

Being able to recognize environmental injuries will give cadets' the confidence to help in an emergency situation that could occur anytime while in a survival situation. Knowing the symptoms and basic treatments for environmental injuries will aid cadets in possibly preventing and detecting an injury earlier.

Teaching Point 1**Explain How to Recognize Hiking Injuries**

Time: 5 min

Method: Interactive Lecture

BLISTERS

Blisters are a sign that boots do not fit properly or are not broken in. Blisters are also a sign that the feet are too tender for the distance being covered in the hike. The first sign of a blister is hot spots. Upon noticing a blister, relieve the pressure on the area by loosening the boots, removing a pair of socks, or even cutting a hole in the socks around the offending area.

SHIN SPLINTS

Shin splints are characterized as pain in the front of the lower leg. Shin splints primarily come from excess toe flexion (bending). Shin splints are usually caused by walking without extending the ankle on each step and not using the toes to press down on the ground. Do not wear clogs of any kind because the ankle needs to stay flexed to keep the clog on the foot.

MUSCLE CRAMPS

Muscle cramps are often associated with dehydration. Muscle cramps commonly occur in people who overwork their muscles to the point of exhaustion. Some possible causes of muscle cramps include:

- lack of water;
- lack of calcium;
- lack of potassium; and
- lack of sodium.

SPRAINS

A sprain occurs when the ligaments of a joint are torn by a sudden twist or wrench. Symptoms of a sprain can include the joint being very painful when moved, and considerable swelling. First aid for a sprain includes wrapping the joint in a heavy bandage and resting the limb in a comfortable elevated position.



Inform the cadets that if they experience any of the above mentioned symptoms they should tell someone immediately and go to the nearest first aid station.

CONFIRMATION OF TEACHING POINT 1

QUESTIONS

- Q1. What are blisters a sign of?
- Q2. What is the primary cause of shin splints?
- Q3. What are the common causes of muscle cramps?
- Q4. What first aid should be administered for a sprain?

ANTICIPATED ANSWERS

- Q1. Blisters are a way of telling the body that one's boots do not fit, they are not broken in or one's feet are too tender for the miles they are covering in their hike.
- Q2. Shin splints primarily come from excess toe flexion.
- Q3. Lack of water, lack of calcium, lack of potassium, and lack of sodium.
- Q4. First aid for a sprain includes wrapping the joint in a heavy bandage and resting the limb in a comfortable elevated position.

Teaching Point 2**Explain How to Recognize Frostbite Injuries**

Time: 5 min

Method: Interactive Lecture

FROSTBITE

There are several types of frostbite. Each of the types is increasingly worse than the previous. The types of frostbite include:

- **Incipient Frostbite or Frostnip.** This type of frostbite is the initial pain from the cold. It is followed by numbness and after rewarming, a tingling feeling. No permanent damage occurs with this type of frostbite.
- **Superficial Frostbite.** This type of frostbite affects only the skin and tissue that is near the surface. The affected area will be white and frozen to the touch, but the tissue beneath it will be soft and resilient. In worse cases, blisters will form after 24 to 36 hours and the pain of the injury may last several weeks.
- **Deep Frostbite.** This frostbite is more serious and involves deeper tissue, possibly as deep as the bone. Before rewarming, the injured area will be hard. Blisters usually form in three to seven days and will be larger than in superficial frostbite. There will be a significant amount of swelling, which can last several weeks.

CONFIRMATION OF TEACHING POINT 2**QUESTION**

- Q1. What are the three types of frostbite?

ANTICIPATED ANSWER

- A1. Incipient frostbite or frostnip, superficial frostbite and deep frostbite.

Teaching Point 3**Explain How to Recognize the Signs and Symptoms of Hypothermia**

Time: 5 min

Method: Interactive Lecture

HYPOTHERMIA

Hypothermia means too little heat. In medical terms, it means a lowering of the body's core temperature, resulting in the breakdown of bodily functions.

Some factors that contribute to hypothermia:

- lack of proper nutrition or hydration;

- inadequate clothing;
- getting wet; and
- exhaustion.

Some hints to prevent hypothermia:

- wearing a sufficient thickness of insulation;
- having protection from the wind;
- keeping dry (inside and out);
- maintaining proper nutrition and hydration; and
- pacing oneself to prevent fatigue.

Signs to watch for in others:

- complaints of feeling cold;
- stumbling;
- falling;
- slurred speech;
- violent shivering;
- poor judgement;
- irrational behaviour; and
- in extreme cases loss of urinary control and fruity acetone breath.

Signs for individuals to watch for in themselves:

- feeling of deep cold;
- shivering;
- stumbling;
- falling; and
- poor coordination.

CONFIRMATION OF TEACHING POINT 3

QUESTIONS

- Q1. What are some factors that contribute to hypothermia?
- Q2. What are the signs of hypothermia to watch for in others?
- Q3. What are the signs of hypothermia to watch for in yourself?

ANTICIPATED ANSWERS

- A1. Lack of proper nutrition or hydration, inadequate clothing, getting wet and exhaustion.

- A2. Complaints of feeling cold, stumbling, falling, slurred speech, violent shivering, bad judgement, irrational behaviour. People with profound hypothermia may lose urinary control and have fruity acetone breath.
- A3. Feeling of deep cold, shivering, stumbling, falling and poor coordination.

Teaching Point 4**Explain How to Recognize Heat Related Injuries**

Time: 5 min

Method: Interactive Lecture

HEAT CRAMPS

Heat cramps are usually the first warning of heat exhaustion. They occur in the muscles that are doing the most work such as the arms, legs and abdomen. Heat cramps are usually due to a lack of body salt.

Symptoms of heat cramps include:

- shallow breathing;
- vomiting; and
- dizziness.

Treatment for heat cramps includes:

- moving to shade;
- resting; and
- drinking water with a small amount of salt dissolved in it.

HEAT EXHAUSTION

Heat exhaustion is produced by exposure to high temperature and humidity. It is also produced through the loss of body fluids through excessive sweating. It can occur without direct exposure to the sun.

Symptoms of heat exhaustion include:

- pale face;
- cold and sweating skin;
- weak pulse accompanied by dizziness;
- weakness;
- cramps; and
- deliriousness or unconsciousness.

Treatment for heat exhaustion includes:

- moving to shade;
- resting; and
- drinking water with a small amount of salt dissolved in it.

HEATSTROKE

Heatstroke is the most serious result of overexertion or overexposure to the sun.

Symptoms of heatstroke include:

- hot dry skin;
- flushed face and feverish;
- sweating stops;
- rising temperature;
- fast, strong pulse;
- severe headache;
- vomiting; and
- unconsciousness.

Treatments for heatstroke include:

- laying in the shade with head and shoulders slightly raised;
- removing layers of outer clothing;
- cooling body by wetting clothing with tepid (warm) water and fanning; and
- sprinkling water over the individual (do not fully immerse the individual in water).

SUNBURN

A sunburn with blistering is dangerous, especially with pale and sensitive skins.

Treatment for sunburn includes:

- avoiding further exposure to the sun by keeping in the shade or covering skin with clothes;
- taking painkillers if available; and
- covering all blisters with dressings (do not burst the blisters).

SORE EYES

Sore eyes may occur due to glare or excessive exposure to the sun or dust particles.

Treatment for sore eyes includes:

- resting in the shade;
- covering eyes after washing out the foreign debris;
- bathing eyes in warm water;
- using a mask to cover the eyes; and
- darkening below eyes with charcoal to avoid recurrence.

DEHYDRATION

Dehydration becomes more noticeable as more body fluid is lost. Water makes up 75 percent of the body's weight. Survival is unlikely if more than one fifth of the body's water is lost.

For fluid loss between 1 to 5 percent of body weight, symptoms include:

- thirst;
- vague discomfort;
- lack of appetite;
- flushed skin;
- impatience;
- sleepiness; and
- nausea.

For fluid loss between 6 to 10 percent of body weight, symptoms include:

- dizziness;
- headache;
- laboured breathing;
- no salivation;
- indistinct speech; and
- unable to walk.

For fluid loss between 11 to 20 percent of body weight, symptoms include:

- delirium;
- swollen tongue;
- inability to swallow;
- dim vision;
- numb; and
- shrivelled skin.

In the latter stages of dehydration, there is significant muscular weakness and impaired mental capacity.



Inform the cadets that if they experience any of the symptoms listed in this class to tell someone immediately and go to the nearest first aid station.

CONFIRMATION OF TEACHING POINT 4

QUESTIONS

- Q1. What are the symptoms of heatstroke?
- Q2. Survival is unlikely if how much of the body's water is lost?
- Q3. What is the treatment for heat exhaustion?

ANTICIPATED ANSWERS

- A1. Hot dry skin, flushed face and feverish. Sweating stops, temperature rises, pulse becomes fast and strong, severe headache, often vomiting and unconsciousness may follow.
- A2. One fifth.
- A3. Moving to shade, resting and drinking water with a little salt dissolved in it.

END OF LESSON CONFIRMATION

ACTIVITY

Time: 7 min

OBJECTIVE

The objective of this activity is for the cadets to recognize environmental injuries as they pick slips of paper out of a container.

RESOURCES

- Cut out the slips of paper found in Annex D. Answer key is provided in Annex E.
- Container (e.g. a bag or hat) for cadets to pick slips from.

ACTIVITY LAYOUT

- Place the cut up slips of paper in the container.
- Divide the class into three groups.
- Have group one pick a slip and read out what is on the slip. The group will then briefly discuss the answer.
- After the discussion, the group will present the answer.
- Continue until all the slips of paper have been picked and discussed.

SAFETY

N/A.

INSTRUCTOR GUIDELINES

- During the activity, monitor the cadets' progress and ensure all members of the class are participating.
- Answer any questions the cadets may have and correct any errors.
- Ensure discussion time is kept short.

CONCLUSION

HOMEWORK/READING/PRACTICE

N/A.

METHOD OF EVALUATION

There is no formal assessment of the EO.

CLOSING STATEMENT

Environmental injuries can be very serious and life threatening. Understanding the symptoms and basic treatments for these injuries will provide individuals with the knowledge to possibly prevent and detect an injury earlier.

INSTRUCTOR NOTES/REMARKS

N/A.

REFERENCES

- C3-002 (ISBN 0-00-2653140-7) Wiseman, J. (1999). *The SAS Survival Handbook*. Hammersmith, London: Harper Collins.
- C3-003 (ISBN 1-896713-00-9) Tawrell, P. (1996). *Camping and Wilderness Survival: The Ultimate Outdoors Book*. Green Valley, Ontario: Paul Tawrell.
- C3-007 (ISBN 0-684-85909-2) Harvey, M. (1999). *The National Outdoor Leadership School's Wilderness Guide*. New York: Simon & Schuster.
- C3-013 (ISBN 0-7360-4602-X) Clark, N. (2003). *Nancy Clark's Sports Nutrition Guidebook*. United States: Nancy Clark.
- C3-014 (ISBN 0-3955-2808-9) Alter, J. (1986). *Stretch & Strengthen*. United States: Judith Alter.
- C3-015 (ISBN 089886-643-X) Weiss, H. (1992). *Secrets of Warmth for Comfort or Survival*. Seattle, WA: The Mountaineers.

THIS PAGE INTENTIONALLY LEFT BLANK



ROYAL CANADIAN AIR CADETS

LEVEL ONE

INSTRUCTIONAL GUIDE



SECTION 9

EO C190.03 – TIE KNOTS AND LASHINGS

Total Time:

60 min

INTRODUCTION

PRE-LESSON INSTRUCTIONS

A complete list of resources needed for the instruction of this EO is located at Chapter 2 of the QSP. Specific uses for said stores are identified throughout the Instructional Guide, within the teaching point for which they are required.

Prior to instructing this lesson the instructor is required to:

- review the lesson content and become familiar with the material;
- prepare a suitable instructional area; and
- prepare lengths of cord or rope for each cadet.

PRE-LESSON ASSIGNMENT

N/A.

APPROACH

The interactive lecture method was chosen as it allows the instructor to make a semi-formal presentation of the material where the cadets can participate by asking or responding to questions and commenting on the material. For this lesson, this method is most effective as it matches well the taxonomic level of the material and is age-appropriate by virtue of its participatory nature.

The demonstration and performance method was chosen due to the practical nature of the subject matter. These methods provide the instructor the opportunity to introduce the subject matter, demonstrate procedures and observe the cadets practicing and performing the skill. The demonstration and performance methods must always be used when the taxonomic level of the material requires a performance of a skill. These methods are highly developmentally appropriate for young cadets.

REVIEW

N/A.

OBJECTIVES

By the end of this lesson the cadet shall be expected to tie knots and lashings.

IMPORTANCE

Without the skill of tying knots and lashings, cadets may be unable to construct sturdy shelters, snares and camp craft. Selecting the appropriate knot for the appropriate situation will provide strength to a structure.

Teaching Point 1**Explain the Parts of a Rope**

Time: 5 min

Method: Interactive Lecture

PARTS OF A ROPE

The following definitions will assist cadets when tying each knot or lashing. Use the following diagram to make an OHP as a reference for the cadets.

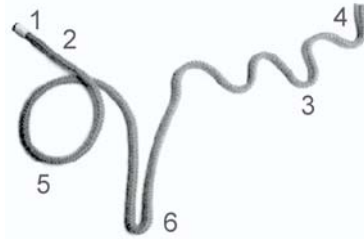

Pocket Guide to Knots and Splices, Des Pawson, 1991

Figure 15-9-1 Parts of a Rope

1. **Working End (Running End).** The very end of the rope that is used during the tying of the knot.
2. **Working Part (Running Part).** The short length of rope that is manipulated to make the knot.
3. **Standing Part.** Part of the rope that usually “stands still” during the knot tying process. Often it is the longer end that leads away from the loop, bight or knot.
4. **Standing End.** The end of the rope not immediately being used in the tying of a knot.
5. **Loop.** (crossing turn).
6. **Bight.** Middle part of a length of rope. This term also refers to a loop of rope that does not cross over itself.

Teaching Point 2**Explain, Demonstrate and Have Cadets Tie Knots**

Time: 25 min

Method: Demonstration and Performance



The instructor shall give several lengths of rope/cord to each cadet. After each of the following knots and lashings are demonstrated, the instructor should allow time for cadets to practice tying the knot with the rope they have been given. If available, other qualified instructors can assist during performance and help maintain class control.

REEF KNOT

The reef knot is used for joining two sections of rope that have the same diameter. This knot can hold a moderate amount of weight and is ideal for first aid use. It may be used when tying slings because the knot lies flat against the body. It is usually made with small to medium diameter rope and is easy to remember because of its simplicity.

Procedure:

1. Place the left hand working end on top of the right hand working end (see Figure 15-9-2, Step 1).
2. Bring the left hand working end under the right hand working end (see Figure 15-9-2, Step 2).
3. Put the working end that is now on the right on top of the working end that is now on the left (see Figure 15-9-2, Step 3).
4. Bring the working end that is on top over then under the other working end so that the working end that is moving comes out of the same place it entered the knot. Pull tight (see Figure 15-9-2, Step 4).
5. The completed knot (see Figure 15-9-2, Step 5).

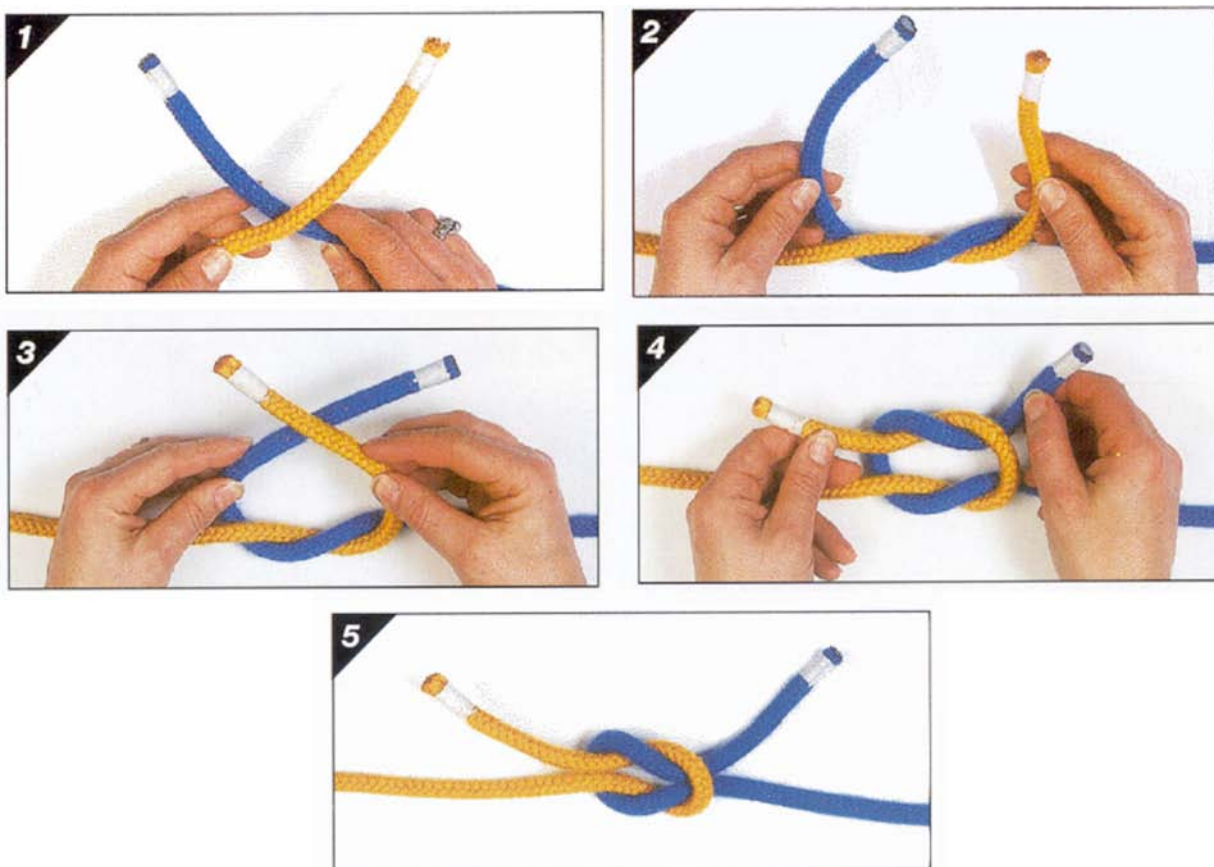

Pocket Guide to Knots and Splices, Des Pawson, 1991

Figure 15-9-2 Reef Knot

SHEET BEND

The sheet bend is one of the simplest and best ways to join two pieces of rope together. It is ideal for ropes that are close in size. This knot was found in a fragment of fishing net that is dated to be 9000 years old. It is the oldest knot ever found. The greater the strain put on this knot, the better the performance of the knot.

Procedure:

1. Fold the end piece of a rope back on itself to form a bight. If the ropes to be joined are varying sizes then the larger of the two should form the bight. Bring the working end of the second piece of rope up through the bight (see Figure 15-9-3, Step 1).
2. Take the working end of the rope around the shorter end of the first rope and on round behind the standing part (see Figure 15-9-3, Step 2).
3. The working end of the second piece of rope is tucked under itself. Pull tight (see Figure 15-9-3, Step 3).

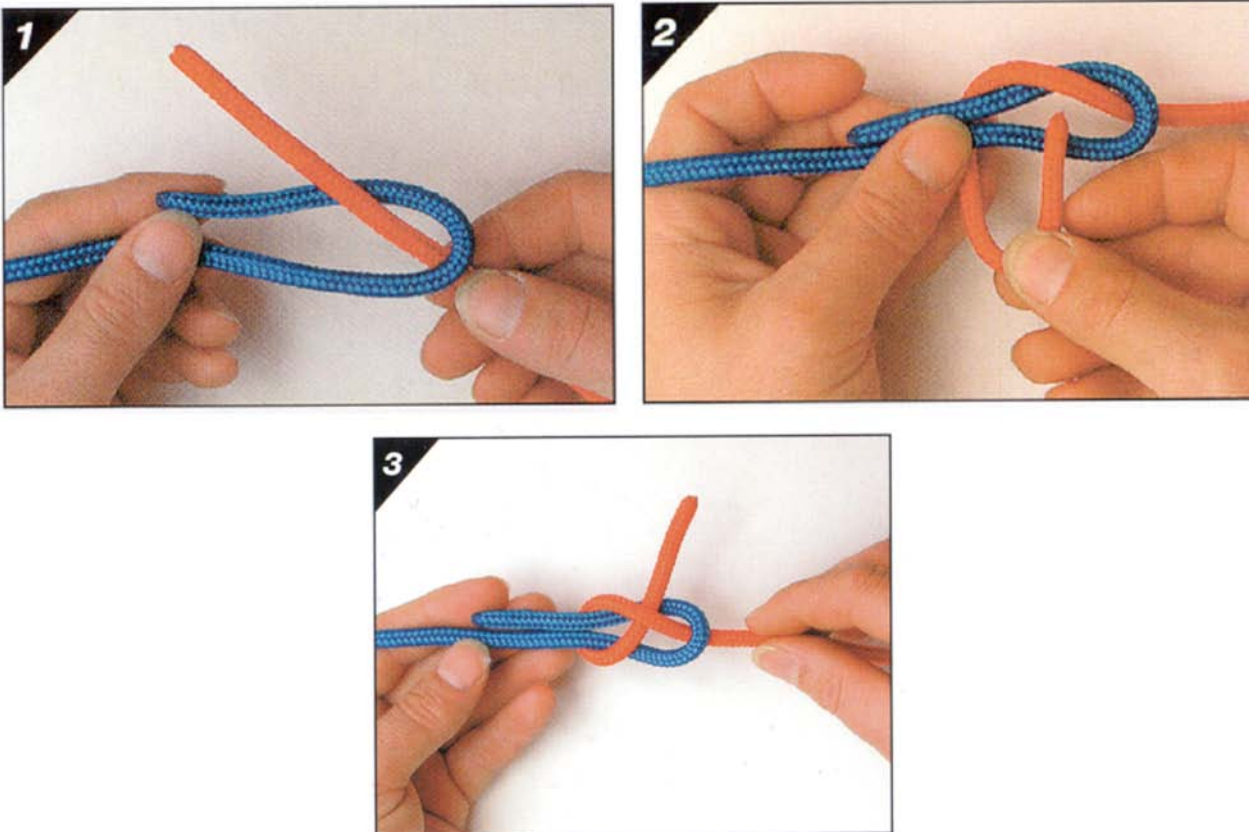

Pocket Guide to Knots and Splices, Des Pawson, 1991

Figure 15-9-3 Sheet Bend

CLOVE HITCH

The clove hitch consists of two half hitches or crossing turns each made in the same direction. It is used to secure a rope to a tree or to start and finish lashings. Under heavy tension the knot may jam and become difficult to untie.

Procedure:

1. Make a turn around the post or tree bringing the working end of the rope over and trapping the standing part of the rope – this makes the first half hitch (see Figure 15-9-4, Step 1).
2. Bring the working end round behind the post/tree, above the first half hitch (see Figure 15-9-4, Step 2).
3. Put the working end under the turn just made. This gives the second half hitch and forms the clove hitch (see Figure 15-9-4, Step 3).
4. The completed knot (see Figure 15-9-4, Step 4).

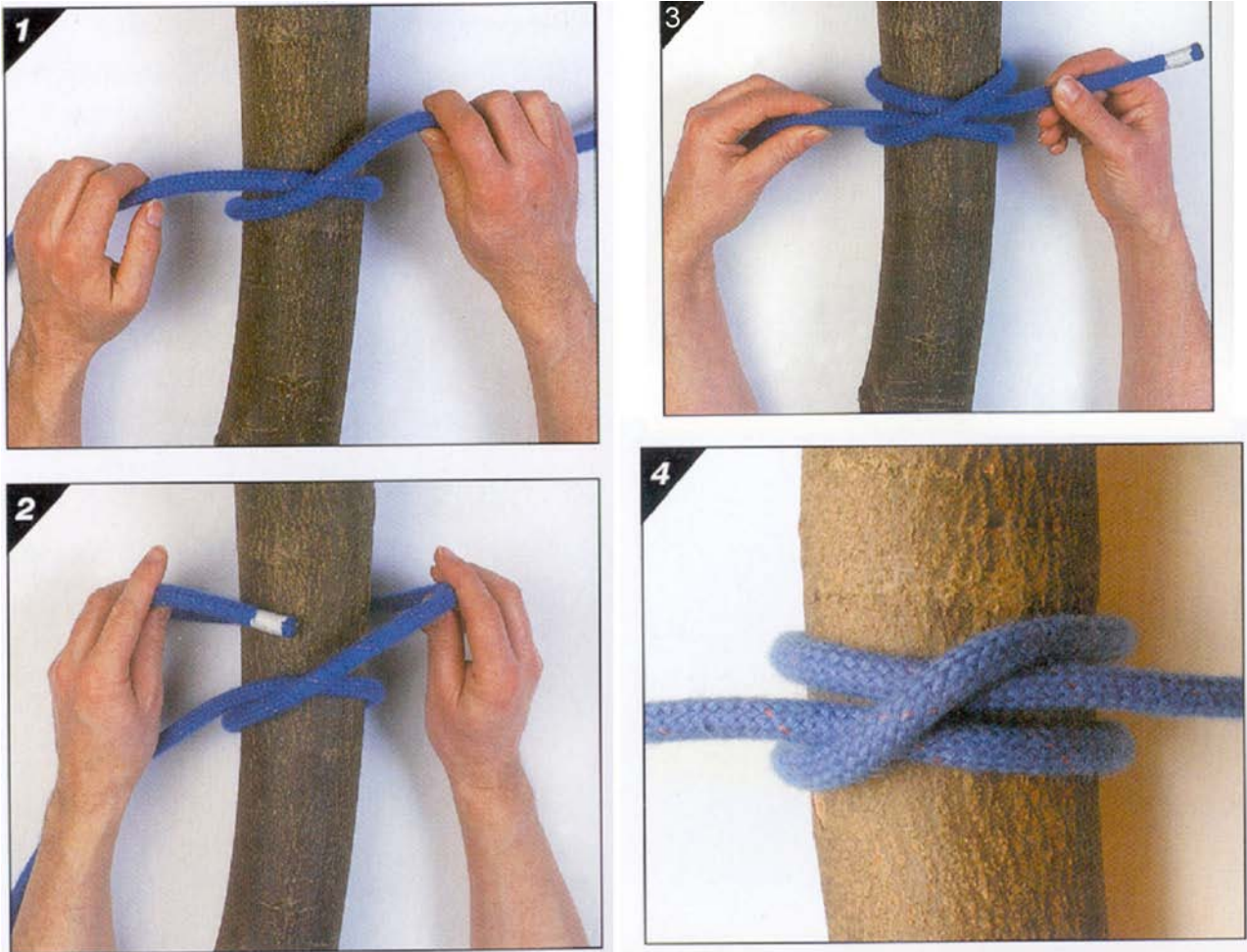

Pocket Guide to Knots and Splices, Des Pawson, 1991

Figure 15-9-4 Clove Hitch

BOWLINE

The bowline is a very secure knot that will not slip, regardless of the load applied. It is commonly used by mountain climbers to tie climbing ropes around their waists. Use this knot whenever a non-slip loop is required at the end of a line.

Procedure:

1. A short distance back from the working end, make a crossing turn with the working part on top. Go on to form the size of loop you require (see Figure 15-9-5, Step 1).

2. Bring the working end up through the crossing turn – it will go under first, then lie on top of the other part of the turn (see Figure 15-9-5, Step 2).
3. Bring the working end around behind the standing part and down through the crossing. A good way to remember this is: “the rabbit comes out of the hole, around the tree and back down the hole again” (see Figure 15-9-5, Step 3).
4. Completed bowline (see Figure 15-9-5, Step 4).

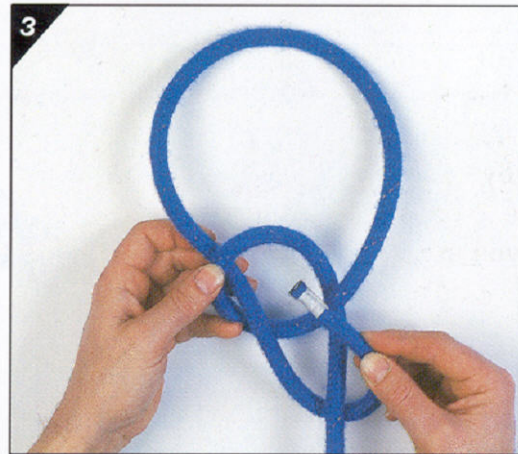
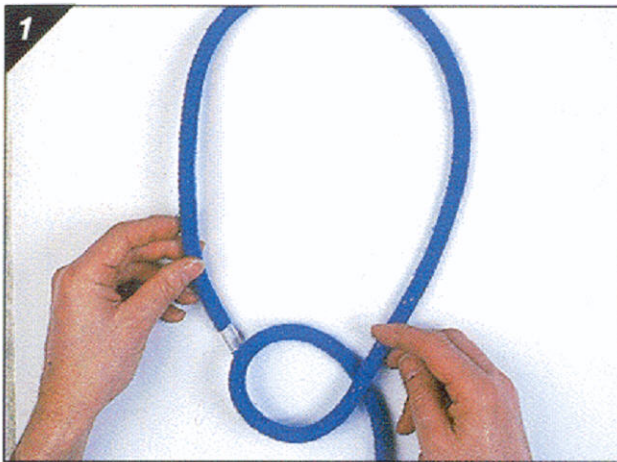

Pocket Guide to Knots and Splices, Des Pawson, 1991

Figure 15-9-5 Bowline

CONFIRMATION OF TEACHING POINT 2

QUESTIONS

- Q1. What is the reef knot used for?
- Q2. What is a clove hitch used for?
- Q3. Which knot creates a non-slip loop at the end of the line?

ANTICIPATED ANSWERS

- A1. Tying two lengths of rope together that are the same diameter.
- A2. Securing a rope to a tree or a pole and finishing lashings.
- A3. Bowline.

Teaching Point 3

Explain, Demonstrate and Have Cadets Tie Lashings

Time: 25 min

Method: Demonstration and Performance

ROUND LASHING

This lashing is used to attach or extend the length of spars or logs. This lashing can be used when building a shelter or other camp craft.

Procedure:

1. Begin with a clove hitch around both spars, and then bind the rope around them tightly (see Figure 15-9-6, a).
2. Ensure that the rope stays very close together. Finish with another clove hitch when finished wrapping. A wedge can be forced under the lashings to make them extremely tight. Stand the spars up vertically and bang the wedge into the lashing (see Figure 15-9-6, b).

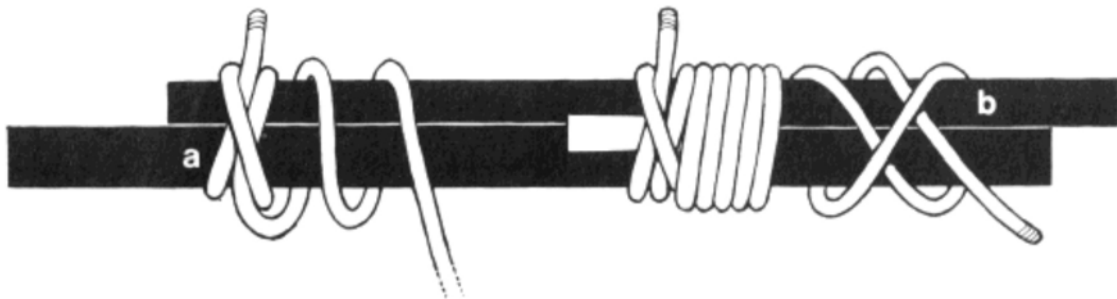

The SAS Survival Handbook, John Wiseman, 1986

Figure 15-9-6 Round Lashing

SQUARE LASHING

A square lashing ties two poles or spars together at 90 degrees. The rope used to make the lashing should be considerably smaller than the size of the poles. For the lashing to be effective, each turn must be pulled as tight as possible as it is made.

Procedure:

1. With the vertical pole on top of the horizontal pole, make a clove hitch on the vertical pole just below the horizontal pole (see Figure 15-9-7, Step 1).
2. Bring all the rope around behind the horizontal pole (see Figure 15-9-7, Step 2).
3. Bring the rope over the vertical pole and back behind the horizontal pole back to the clove hitch (see Figure 15-9-7, Step 3).

4. Carry on making two or three more complete turns right round the two poles, pulling tight after each turn (see Figure 15-9-7, Step 4).
5. After passing the clove hitch, bring the rope around the horizontal pole from behind and start to wrap round the junction between the two poles. These are frapping turns – pull them as tight as possible (see Figure 15-9-7, Step 5).
6. Make two complete sets of frapping turns (see Figure 15-9-7, Step 6).
7. Finish off with a clove hitch around the horizontal pole (see Figure 15-9-7, Step 7).
8. Finished lashing (see Figure 15-9-7, Step 8).

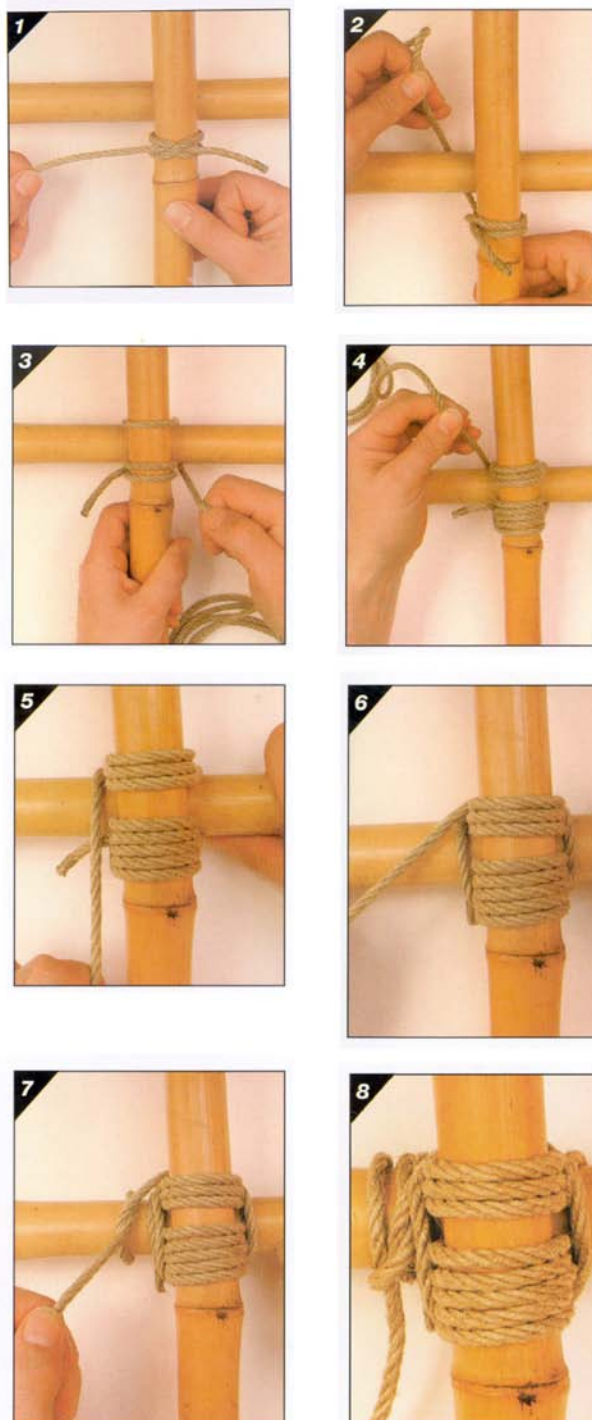

Pocket Guide to Knots and Splices, Des Pawson, 1991

Figure 15-9-7 Square Lashing

SHEER LASHING

The sheer lashing has two distinctive uses. It can create an A-frame or a set of sheer legs using a single sheer. A number of sheer lashings can be used to extend the length of a spar. To make the A-frame, two poles are put side-by-side with the lashing made at one end. When tying the initial turns of the rope, do not pull them

very tight. The loose lashing will allow the A-frame legs to come apart with ease when the lashing is complete. Pull tight when extending the length of a spar.

Procedure:

1. Start by making a clove hitch around both poles (see Figure 15-9-8, Step 1).
2. Wrap round both poles, trapping the end of the clove hitch (see Figure 15-9-8, Step 2).
3. Carry on making eight or ten more turns around the two poles. The lashing could be finished by tying a clove hitch (see Figure 15-9-8, Step 3).
4. Add a couple of frapping turns by bringing the end of the rope between the two poles (see Figure 15-9-8, Step 4).
5. Finish off with a clove hitch around one of the poles (see Figure 15-9-8, Step 5).
6. The finished sheer lashing with the poles parallel (see Figure 15-9-8, Step 6).
7. The finished lashing with the poles opened to create an A-frame (see Figure 15-9-8, Step 7).

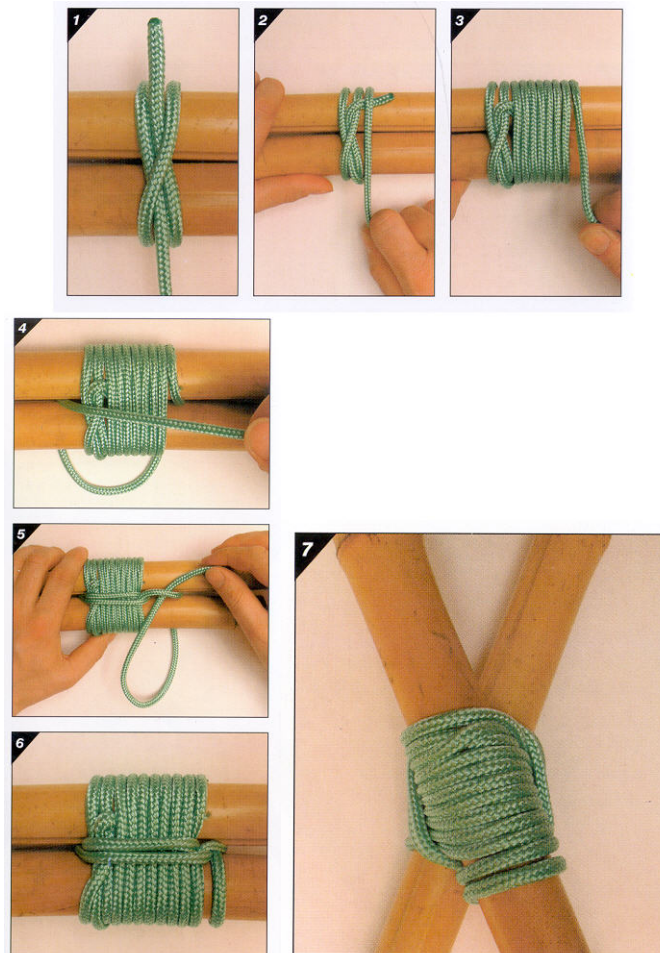

Figure 15-9-8 Sheer Lashing

TRIPOD LASHING

This lashing is used to join three poles together to create a tripod. Three poles are laid side-by-side and a clove hitch is made around one of the outside poles a short distance from the end. The lashing line is then woven in

and out of the three poles, frapping turns are put in and another clove hitch is put around one of the outside poles to finish the lashing.

Procedure:

1. Start with a clove hitch around one of the outside poles. Lead the rope under and over the other two poles (see Figure 15-9-9, Step 1).
2. Go around the pole furthest away from the start and weave the rope back over and under (see Figure 15-9-9, Step 2).
3. Continue to weave the rope in this manner for seven to eight full passes before bringing the rope up between two of the poles (see Figure 15-9-9, Step 3).
4. Pull the rope parallel to the poles and start to put in some frapping turns (see Figure 15-9-9, Step 4).
5. After making frapping turns between the first two poles move on to make frapping turns around the other two poles (see Figure 15-9-9, Step 5).
6. Finish off with a clove hitch around the pole that was first started with (see Figure 15-9-9, Step 6).
7. The tripod can now be opened (see Figure 15-9-9, Step 7).

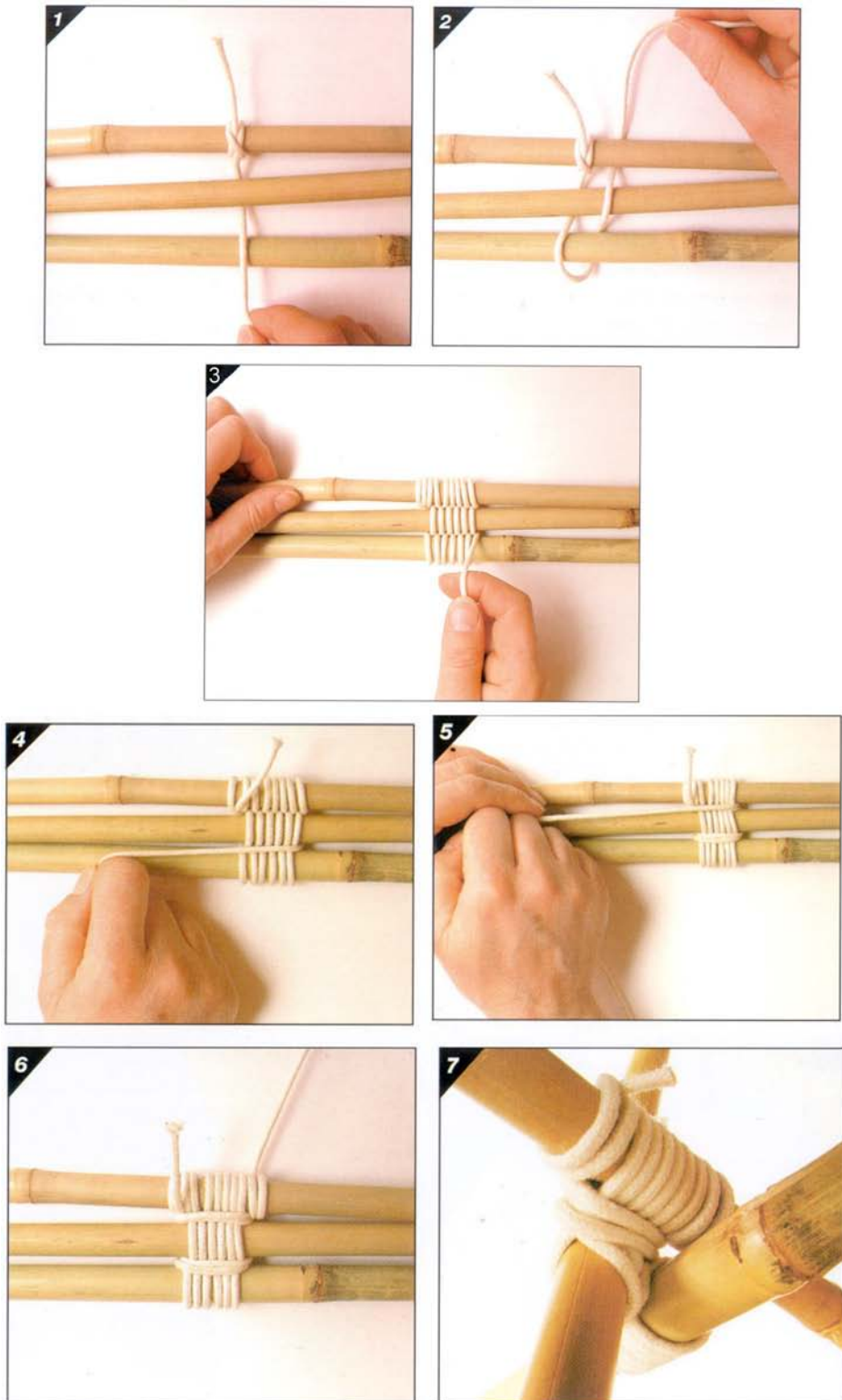

Pocket Guide to Knots and Splices, Des Pawson, 1991

Figure 15-9-9 Tripod Lashing

ACTIVITY

Time: 10 min

OBJECTIVE

The objective of this activity is to confirm that each cadet has grasped the skills required to tie knots and lashings.

RESOURCES

- Four to five desks.
- Two lengths of rope per group.
- Two poles per group.

ACTIVITY LAYOUT

- Divide cadets into groups of four.
- At the front of the instructional area set-up one desk per group.
- Direct each group to line-up in a single file line approximately five metres behind a desk.
- Place two lengths of rope and two poles on each desk.
- On the command to commence, one group member will approach the desk and tie a knot or a lashing. Once the cadet is finished and the instructor has ensured that the knot or lashing is correct, he or she will return to the line. The second cadet will then approach the desk and complete a different knot or lashing.
- Cadets will take turns tying the knots and lashings until all eight are complete.
- The first group to complete all four knots and all four lashings is the winner of the relay.

SAFETY

N/A.

INSTRUCTOR GUIDELINES

- Ensure that each knot or lashing is correctly tied before allowing the next cadet to carry on.
- It is best to have cadets in groups of four so each cadet must do two knots or lashings.
- If available, use other instructors to assist in ensuring each lashing is correct.
- If the group is too large to complete this activity in the allotted time, use the time for cadets to practice each knot and lashing while providing assistance and feedback.

CONFIRMATION OF TEACHING POINT 3

QUESTIONS

- Q1. What knot is used to start and finish most lashings?
- Q2. What is the square lashing used for?
- Q3. What are the two most common uses for the sheer lashing?

ANTICIPATED ANSWERS

- A1. Clove hitch.
- A2. Connect to poles/spars at a 90 degree angle.
- A3. Create an A-frame or extend a pole/spar.

END OF LESSON CONFIRMATION

Confirmation will be completed during the activity following TP3. Verbal questioning may be used in addition to this activity.

CONCLUSION

HOMEWORK/READING/PRACTICE

N/A.

METHOD OF EVALUATION

There is no formal assessment of this EO.

CLOSING STATEMENT

Cadets have learned the skills required to create four knots and four lashings. Without these skills, cadets may be unable to construct sturdy shelters, snares and camp craft. Selecting the appropriate knot for the situation will provide strength to a structure.

INSTRUCTOR NOTES/REMARKS

N/A.

REFERENCES

- C3-002 (ISBN 0-00-653140-7) Wiseman, J. (1999). *The SAS Survival Handbook*. London: Harper Collins.
- C3-025 (ISBN 0-688-01226-4) Bigon, M., and Regazzoni, G. (1981). *The Morrow Guide to Knots*. New York: Quill/William Morrow.
- C3-026 (ISBN 1-55267-218-2) Pason, D. (2001). *Pocket Guide to Knots and Splices*. London: PRC Publishing.
- C3-027 (ISBN 0-7627-0428-4) Jacobson, C. (1990). *Basic Essentials Knots for the Outdoors*. Guildford, CT: The Globe Pequot Press.



ROYAL CANADIAN AIR CADETS

LEVEL ONE

INSTRUCTIONAL GUIDE



SECTION 10

EO C190.04 – RESPECT THE ENVIRONMENT IN THE FIELD

Total Time: 30 min

INTRODUCTION

PRE-LESSON INSTRUCTIONS

A complete list of resources needed for the instruction of this EO is located at Chapter 2 of the QSP. Specific uses for said stores are identified throughout the Instructional Guide, within the teaching point for which they are required.

Prior to instructing the lesson the instructor is required to:

- review the lesson content and become familiar with the material;
- select an appropriate site for instructing the class; and
- ensure the following materials are ready prior to the class:
 - an example of biodegradable soap or shampoo; and
 - a stove fuel cartridge.

PRE-LESSON ASSIGNMENT

N/A.

APPROACH

The interactive lecture method was chosen as it allows the instructor to make a semi-formal presentation of the material where the cadets can participate by asking or responding to questions and commenting on the material. For this lesson, this method is most effective as it matches well the taxonomic level of the material and is age-appropriate by virtue of its participatory nature.

REVIEW

N/A.

OBJECTIVES

By the end of this lesson the cadet shall be expected to:

- describe the importance of low impact camping; and
- identify factors important to respecting the environment while cooking, washing, and disposing of waste.

IMPORTANCE

Cadet squadrons are at survival training sites only a few days out of a year. However, these areas are home to a variety of wildlife and vegetation. By following proper protocol, the wilderness can be preserved, securing a home for wildlife as well as future field exercises for groups such as The Canadian Cadet Organization.

Teaching Point 1

Discuss the Importance of Low Impact Camping

Time: 10 min

Method: Interactive Lecture



During this teaching point, the instructor should try to select a location where both good and poor examples of low impact camping are present.

LOW IMPACT CAMPING CONCERNS

The goal of low impact camping is to leave the training area in the condition it was before being used. There should be little indication that the area had been used at all.

The wilderness is sourced for wood; burned, paved, and otherwise destroyed. However, action has been taken to preserve the environment. Recycling is one example of actions that have been taken.

POSSIBLE OUTCOMES OF ENVIRONMENTAL OVERUSE

With camping and hiking becoming increasingly popular, it is important to treat the environment with respect. The overuse of environmental resources could cause:

- an excess build-up of garbage;
- barren, stripped land;
- exposed tree roots;
- destroyed plants, or absence of vegetation; and
- scarred trees where branches have been torn away.

These outcomes affect the environment negatively. For example, the amount of garbage in a wilderness area can pollute the ground, the water, and the wildlife that live there.

ENVIRONMENTAL PRECAUTIONS

Through people taking responsible actions and following proper precautions, a site can be left in its natural condition for continuous use. This environmental consciousness will help wildlife and plants to recover from the impact of field training. A number of precautions can be taken to include:

- packing out all garbage, including used stove cartridges and other non-burnable trash;
- staying on trails whenever possible; do not create new paths by cutting down vegetation;
- avoiding crushing plants underfoot by walking on rocks and compacted earth;
- no harassing or feeding animals;
- where campfires are allowed, gathering fallen branches instead of cutting down trees for firewood; and

- using designated fire pits for campfires.

CONFIRMATION OF TEACHING POINT 1

QUESTIONS

- Q1. When creating a fire, what should one keep in mind when collecting firewood?
- Q2. Why should you stay on trails whenever possible?
- Q3. If you come across various forms of wildlife, what precautions should one keep in mind?

ANTICIPATED ANSWERS

- A1. Gather branches instead of cutting down trees for firewood.
- A2. So vegetation is left alone and not trampled.
- A3. Do not harass the animals or feed them.

Teaching Point 2

Identify Important Environmental Factors When Cooking

Time: 4 min

Method: Interactive Lecture

IMPORTANT FACTORS WHILE COOKING IN THE FIELD

There are a number of factors that should be considered while cooking in the field. They include:

- avoid dropping or draining food on the ground in your cooking area;
- waste water from cooking, when cooled, should be evenly distributed across the ground away from the cooking area and bivouac site;
- do not dump waste water into ground water;
- after meals, garbage should be packed-up immediately; and
- pack wet waste in a sealed container or a plastic bag, separate from dry garbage.

RECYCLING IN THE FIELD

It is very important to divide up garbage for recycling. There are different recycling groups for cardboard, paper, metal, glass, plastic and rigid foam.

CONFIRMATION OF TEACHING POINT 2

QUESTIONS

- Q1. What factors should be taken into account when disposing of waste water from cooking?
- Q2. What is important to keep in mind when disposing of wet waste?
- Q3. What are the different types of recyclable materials?

ANTICIPATED ANSWERS

- A1. It should be cooled and evenly distributed across the ground, away from the cooking area and bivouac site.

A2. Wet waste should be sealed in a container or plastic bag.

A3. Cardboard, paper, metal, plastic and rigid foam, glass.

Teaching Point 3

Identify Important Environmental Factors When Washing

Time: 4 min

Method: Interactive Lecture

IMPORTANT ENVIRONMENTAL FACTORS WHILE WASHING

It is important to maintain proper hygiene while in the field. If soap is going to be used while bathing in the field, certain precautions should be kept in mind:

- select a site on high and dry ground that is at least 100 metres away from a ground water source;
- sponge bathe from a basin of water, using as little soap as possible; and
- once bathing is finished, ensure that the grey water is disposed of properly into a grey water container;
- biodegradable soaps and shampoos should be used.

Also, before swimming in a large body of water, ensure that any oils (e.g. sunscreen, grease, fuel residue, bug repellent, body oils, etc.) are removed in order to ensure there is no water contamination from the presence of these items.



The instructor should show an example of biodegradable soaps and shampoos to the cadets at the end of this teaching point.

CONFIRMATION OF TEACHING POINT 3

QUESTIONS

- Q1. What should be washed off before going swimming?
- Q2. If using soap, where should one bathe?
- Q3. If using soap to bathe, what form of soap should be used?

ANTICIPATED ANSWERS

- A1. Different types of oils (e.g. sunscreen, grease, fuel residue and body oils).
- A2. Ensure the site is on high and dry ground and at least 100 metres away from a ground water source.
- A3. Biodegradable soap.

Teaching Point 4**Discuss Proper Disposal of Human Waste in the Field**

Time: 6 min

Method: Interactive Lecture

PROPER DISPOSAL OF HUMAN WASTE

There are a number of factors that should be considered with respect to waste disposal in the field. Wherever possible, use an established toilet, outhouse or portable toilet. If toilets, outhouses, or portable toilets cannot be used, then a latrine should be dug for communal use. A hole about 60 centimetres x 60 centimetres, 30 to 60 centimetres deep will work for about 20 people for up to two days. When the hole is full to about 15 centimetres from the top, cover it with the remaining dirt and natural cover.



Ensure to check local regulations concerning latrine construction prior to demonstrating this to the class. Some areas do not allow latrine construction.

CONFIRMATION OF TEACHING POINT 4**QUESTIONS**

- Q1. Name three types of facilities that should be used for proper waste disposal as a first resort.
- Q2. If a latrine is constructed (regular measurements), how long will it be suitable?

ANTICIPATED ANSWERS

- A1. An established toilet, outhouse or portable toilet.
- A2. Up to two days.

CONCLUSION**HOMEWORK/READING/PRACTICE**

N/A.

METHOD OF EVALUATION

There is no formal assessment of this EO. Instructors will confirm cadets' comprehension during the end of lesson confirmation.

CLOSING STATEMENT

There are a number of things to keep in mind in order to properly respect the environment. Following proper methods of cooking, washing, and waste disposal are important in preserving the environment. If such practices are followed during survival, the training area can be maintained and used for many years.

INSTRUCTOR NOTES/REMARKS

N/A.

REFERENCES

- C3-005 (ISBN 0-89886-814-9) Sierra Club, San Diego Chapter. (1999). *Wilderness Basics: The Complete Handbook for Hikers & Backpackers*. Portland, Oregon: The Mountaineers Books.
- C3-008 (ISBN 0-02861-100-4) Moulant, M. (1999). *Complete Idiot Guide to Camping and Hiking*. Toronto, Canada: Alpha Books.



ROYAL CANADIAN AIR CADETS

LEVEL ONE

INSTRUCTIONAL GUIDE



SECTION 11

EO C190.05 – IDENTIFY REGIONAL WILDLIFE

Total Time:

30 min

INTRODUCTION

PRE-LESSON INSTRUCTIONS

A complete list of resources needed for the instruction of this EO is located at Chapter 2 of the QSP. Specific uses for said stored are identified throughout the Instructional Guide, within the teaching point for which they are required.

Prior to instructing this lesson the instructor shall:

- review the lesson content, and become familiar with the material;
- research approximately four to six different types of wildlife that are common to the region. The information that should be included at each learning station is included in the background information. A reference for finding the required information is *Hinterland Who's Who* found at www.hww.ca/index_e.asp; and
- Set up learning stations in the training area/classroom with a photo of the animal and the bristol board display (see Activity Section).

PRE-LESSON ASSIGNMENT

N/A.

APPROACH

The small group activity was selected to allow for maximum participation in the learning process. It is an interactive way to illustrate and substantiate the lesson material in a concrete manner.

The group discussion method was chosen to allow the cadets to share their knowledge, opinions, and feelings about the subject matter while still allowing the instructor to control the direction of the discussion. The instructor must ensure that points not brought forth by the class are presented. If the instructor follows the Instructional Guide, including the questions posed, this will allow the cadets to express, in their own words, what they learned from this lesson and how they may apply the information.

REVIEW

N/A.

OBJECTIVES

By the end of this lesson the cadet shall be expected to identify regional wildlife.

IMPORTANCE

The wilderness is home to many types of wildlife. Having background information about the different types of animals in the area will allow the cadet to identify the animal and recognize some of the habits it may have.

BACKGROUND KNOWLEDGE

GENERAL DESCRIPTION

Wildlife includes all non-domesticated organisms. It includes all animals, insects and plants. (<http://www.hww.ca/glossary.asp>).

A general description of the animal should include:

- the physical description of the animal;
- the colour of the animal; and
- any special characteristics/features of the animal.

HABITAT

A habitat is a space that is uniquely suited to an animal's needs through the arrangement of food, water, shelter and cover. A description of the habitat should include:

- the characteristics of the habitat;
- the weather conditions in the area; and
- any other pertinent habitat information the instructor wishes to include.

DIET/FEEDING HABITS

A diet is the sum of the food that an organism consumes. A description of the diet/feeding habits should include:

- different types of food consumed;
- seasonal effects on food; and
- any other pertinent diet/feeding information the instructor wishes to include.

BREEDING CHARACTERISTICS

Reproducing is the act of breeding or producing young. Gestation refers to the actual pregnancy stage. A description of the breeding characteristics should include:

- breeding season;
- gestation period;
- number of young born; and
- any other pertinent breeding characteristics the instructor wishes to include.

UNIQUE CHARACTERISTICS

Many animals possess characteristics that make them unique. For example, a moose's eyesight is extremely poor, but its sense of smell and sense of hearing compensate for it.

ACTIVITY

Time: 15 min

OBJECTIVE

The objective of this activity is to familiarize the cadets with the wildlife common to their region.

RESOURCES

- Bristol board.
- Photo of each animal.
- Index cards.

ACTIVITY LAYOUT

- This activity will be conducted using learning stations. Each animal will be presented to the cadets at the stations.
- Each station will have a picture of the animal, a description of the animal on the bristol board and five index cards.
- Prior to the activity, prepare the bristol board, including all the information outlined in the background information. The information should be written in paragraph form because the cadets will need to pull information from the bristol board as part of the activity. Headings as found in the background information should not be used on the board.
- Prepare five index cards for each station with one heading on each card. The headings include: general description of the animal, habitat, diet, breeding characteristics and unique characteristics.
- Divide the class into groups. The number of groups will match the number of learning stations.
- Place each group at a different station.
- Each group will take three minutes (time may vary depending on the number of stations) to read the information at the station, choose an index card, and then fill in the information on the index card.
- Indicate when it is time to move to the next learning station.
- The groups will take their index card from the stations with them.
- The group should pick a different index card topic at each station if possible.

SAFETY

N/A.

INSTRUCTOR GUIDELINES



At this point the instructor shall brief the cadets on any safety rules or any other guidelines pertaining the activity.

During the activity, supervise the groups at the learning stations, ensure each cadet is participating and answer any questions.

REFLECTION

Time: 10 min

Method: Group Discussion

GROUP DISCUSSION

- Once all the groups have been to each station, the cadets will present their information.
- The presentations should be completed by animal and in the order of headings found in the background information.
- The presentations should be no more than two minutes.



The instructor shall ensure that all lesson objectives are drawn out towards the end of the reflection stage.

DISCUSSION QUESTIONS



TIPS FOR ANSWERING/FACILITATING DISCUSSION

- Ask questions that help facilitate discussion; in other words, avoid questions with yes or no answers.
- Prepare questions ahead of time.
- Be flexible (you are not bound to only the prepared questions).
- Encourage cadets to participate by using praise such as “great idea” or “excellent response, can anyone add to that?”.
- Try to involve everyone by directing questions to non-participants.

SUGGESTED QUESTIONS

- Q1. What resources do the wildlife in this region depend on?
- Q2. How does an animal’s survival in this region compare to our survival while in the field?
- Q3. How does the climate affect the different wildlife in this region?



Other questions and answers will develop throughout the reflection stage. The discussion should not be limited to only those suggested.

CONCLUSION

REVIEW

Upon completion of the group discussion conclude by summarizing the discussion to ensure that all teaching points have been covered. Also take the opportunity to explain how the cadet will apply this knowledge in the future.

MAIN TEACHING POINTS

- TP1. Descriptions of the animals.
- TP2. The animals' habitat.
- TP3. The animals' diet.
- TP4. The animals' breeding characteristics.
- TP5. Unique characteristics of the animals.



The instructor shall reinforce those answers and comments discussed during reflection, but must ensure that the main teaching points have been covered. Any main teaching point not brought out during the group discussion shall be inserted during review.

HOMEWORK/READING/PRACTICE

N/A.

METHOD OF EVALUATION

There is no formal assessment of this EO.

CLOSING STATEMENT

During a survival exercise, wildlife may be encountered. By having some information about the wildlife common to their region, the cadets will be able to identify the animal and have a general understanding of the characteristics of it.

INSTRUCTOR NOTES/REMARKS

N/A.

REFERENCES

- C3-018 *Wikipedia, the Free Encyclopedia.* (2006). Retrieved 24 April 2006, from [http://en.wikipedia.org/wiki/Habitat_\(ecology\)](http://en.wikipedia.org/wiki/Habitat_(ecology)).
- C3-019 *Wikipedia, the Free Encyclopedia.* (2006). Retrieved 24 April 2006, from [http://en.wikipedia.org/wiki/Diet_\(nutrition\)](http://en.wikipedia.org/wiki/Diet_(nutrition)).
- C3-020 *Hinterland Who's Who.* (2006). Retrieved 24 April 2006, from http://www.hww.ca/index_e.asp.

THIS PAGE INTENTIONALLY LEFT BLANK



ROYAL CANADIAN AIR CADETS

LEVEL ONE

INSTRUCTIONAL GUIDE



SECTION 12

EO C190.06 – COLLECT DRINKING WATER IN THE FIELD

Total Time:	60 min
-------------	--------

INTRODUCTION

PRE-LESSON INSTRUCTIONS

A complete list of resources needed for the instruction of this EO is located at Chapter 2 of the QSP. Specific uses for said stores are identified throughout the Instructional Guide, within the teaching point for which they are required.

Prior to instructing this lesson the instructor is required to:

- review the lesson content, and become familiar with the material;
- prepare a suitable instructional area; and
- prepare examples of water collection devices.

PRE-LESSON ASSIGNMENT

N/A.

APPROACH

The interactive lecture method was chosen as it allows the instructor to make a semi-formal presentation of the material where the cadets can participate by asking or responding to questions and commenting on the material. For this lesson, this method is most effective as it matches well the taxonomic level of the material and is age-appropriate by virtue of its participatory nature.

REVIEW

N/A.

OBJECTIVES

By the end of this lesson the cadet shall be expected to conserve and collect water for drinking.

IMPORTANCE

Cadets will obtain the skills to collect water in a survival situation. Water is vital to human survival. Without sufficient drinking water, the body will shut down and eventually die. Having sufficient drinking water combats thirst, which is an enemy of survival.

Teaching Point 1**Describe Steps to Conserve Water**

Time: 15 min

Method: Interactive Lecture

OVERVIEW

Water is essential to life. All living things contain water and depend on it. The average person can survive for approximately three weeks without food but only three days without water. Do not wait until water supplies have completely diminished to find a water source. When faced with a survival situation, conserve water and find a source as soon as possible. The source should be fresh, running water. However, boiling or the use of chemical purifiers can sterilize water. The human body consists of 75 percent water. It is required to keep kidneys functioning so they may eliminate wastes, control body temperature, and regulate the nervous system.

When water is lost from the body, it must be replaced in order to maintain health and efficiency. The human body loses 2 to 3 litres of water per day, which must be replaced to maintain the water balance. This water replacement occurs by consuming actual water or water that is contained in food.

DEHYDRATION

The human body has no means of storing water like it can with food fats. When the body is deprived of water it becomes dehydrated, which can affect it in very negative ways.

Effects of Water Loss

Loss of 1 to 5% Body Water	Loss of 6 to 10% Body Water	Loss of 11 to 12% Body Water
Thirst	Headache	Delirium
Discomfort	Dizziness	Swollen tongue
Lethargy	Dry mouth	Twitching
Impatience	Tingling in limbs	Deafness
Lack of appetite	Blue shade to skin	Darkening vision
Flushed skin	Slurred speech	Lack of feeling in the skin
Increased pulse	Difficulty breathing	Skin starts to shrivel
Nausea	Inability to walk	Inability to swallow
Weakness	Blurred vision	Death

RETAINING FLUIDS

The following precautions can be taken to keep fluid loss to a minimum:

- Avoid exertion.
- Do not smoke.
- Keep cool, stay in the shade.
- Do not lay on hot ground or heated surfaces.
- Eat as little as possible – If you have little fluid in your body, water will be taken from the vital organs to digest the food.
- Avoid alcohol – it takes fluid from the vital organs to break it down.

- Avoid speech.
- Breathe through the nose, not the mouth.

CONFIRMATION OF TEACHING POINT 1

QUESTIONS

- Q1. What percentage of the human body is water?
- Q2. How much water does the human body lose each day?
- Q3. What are three ways to prevent water loss?

ANTICIPATED ANSWERS

- A1. 75 percent.
- A2. 2 to 3 litres.
- A3. Avoid exertion, do not smoke, keep cool, stay in the shade, do not lay on hot ground or heated surfaces, eat as little as possible, avoid alcohol, avoid speech, and breathe through the nose, not the mouth.

Teaching Point 2

Collect Drinking Water

Time: 40 min

Method: Demonstration and Performance

FINDING WATER

Surface characteristics:

- Follow dry riverbeds. The structure and composition of the rocks in the riverbed may result in an emerging stream. The riverbed may also be followed to its source. There may be a trickle of water that remains or humid soil may be present where a pit can be dug to the water table.
- Watch for damp spots on the ground. A high water table can cause this.
- Old human habitations can be a good place to find water. Old mines and dumps are good examples.
- Water may be collected from dew accumulation.

Plants and trees:

- Look for areas with green leaf and tree growth. This vegetation requires a significant amount of water. Plants include: cattails, bulrush, elderberries, and reeds. Trees include: cottonwood, poplar, greasewood, and willow. The green leaves indicate a high water table. Dig a pit approximately 1 to 2 feet deep to find the water.
- Water can be found at the base of cliffs where vegetation is present.
- The pulp from some cacti can be crushed to produce a watery mash.

Animal indicators:

- Animals are the best indicators of desert water.
- Insects live within flying distance of water. Their flight path may be followed to a water source.

- Grazing animals travel to and from a water source every morning and evening. Animals' trails can be followed to a water source.
- Birds may circle a water source or congregate in large flocks. Birds of prey use their victims as a source of fluid and do not travel to water frequently.

COLLECTING WATER

Rainwater

Set out a container to collect any rain that may fall. The flow from the roof of a shelter can be collected using improvised guttering to channel the rain into containers. Rainwater requires less purification than that a standing body of water. Collecting rainwater is also easier than other collection methods.

Stretch a waterproof sheet tightly over a wide area, preferably on a slope. Peg down its corners with sticks and collect the rain in a container. A rock may be used to weigh down the centre and better direct the water into the container. When waterproof sheets are unavailable, use a birch bark sheet and shape it to channel the water into a container.

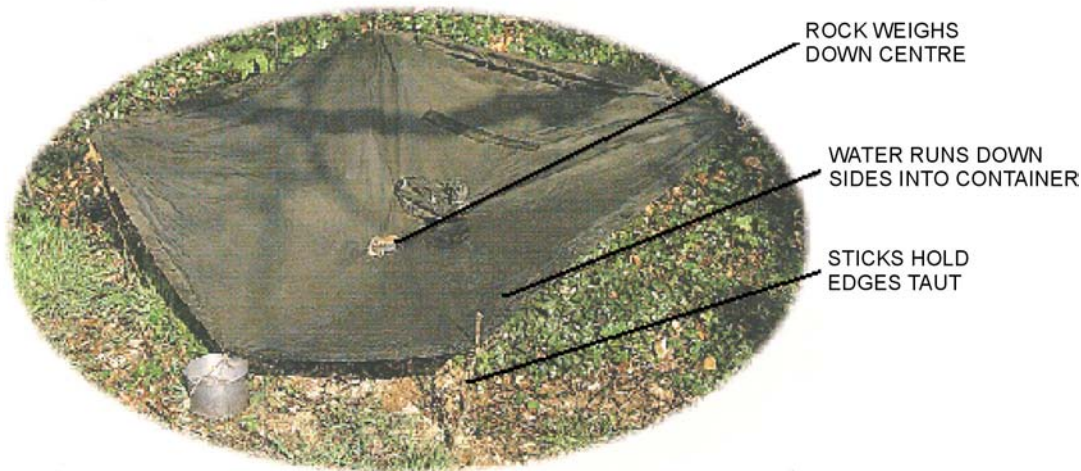

The Complete Wilderness Survival Manual, Hugh McManners, 1994

Figure 15-12-1 Rain Collector

Collecting Dew

As the air cools down at night, the water vapour in the air condenses as dew on low-lying ground, and vegetation. This water evaporates rapidly as the sun rises. Many plants, insects and animals depend upon dew to survive. Humans can also make use of this natural water supply. Dew can be collected by soaking a cloth in long wet grass. The best time for collection is at dawn. When the cloth is soaked, wring the water out into a container. If a cloth is unavailable, a spare T-shirt or other piece of clothing may be used.



The Complete Wilderness Survival Manual, Hugh McManners, 1994

Figure 15-12-2 Dew Collection

Collecting Water From Vegetation

Tie a plastic bag over a healthy, bushy green branch. The water vapour given off by the foliage will heat-up inside the plastic and condense to form water inside of the bag. On trees, keep the mouth of the bag at the top with a corner hanging low to collect condensed evaporation.

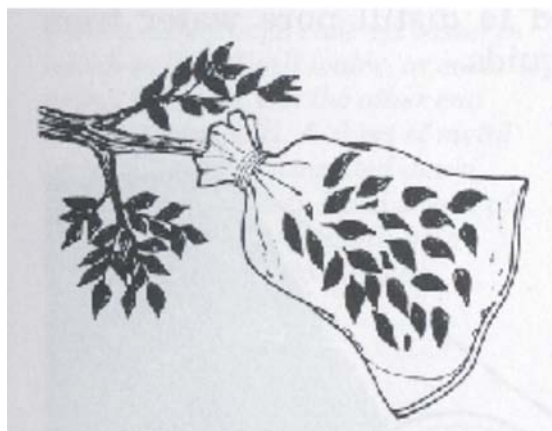

The SAS Survival Handbook, John Wiseman, 1986

Figure 15-12-3 Collecting Condensation

An entire plant can also be used as a water source. Placing a plastic bag over any vegetation will collect moisture by evaporation. The moisture will condense on the plastic as it cools. Suspend the bag to an overhead tree branch, or place a wide stick on the inside to prop up the plastic bag. Arrange points for the water to collect.

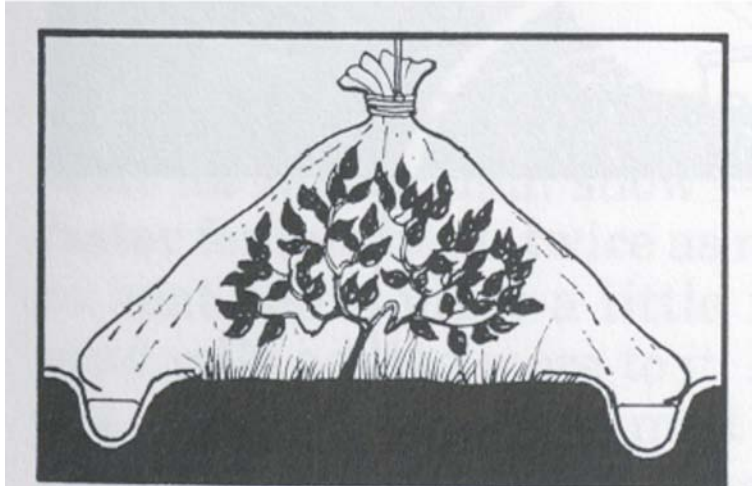

The SAS Survival Handbook, John Wiseman, 1986

Figure 15-12-4 Collecting Condensation From Plants

There are many different types of vegetation that store water in either their leaves or roots. Some types of vegetation capture rainwater in order to trap insects for food. Others secrete special fluids that can be tapped and drunk by humans in emergencies. Some examples include: pitcher plants, cacti, tree roots and vines.

Pitcher Plant. (*Nepenthes spp.*) This plant catches insects in a watery fluid in its “pitcher.” You can extract the water, but it must then be strained to remove any insects (which you can eat).



The Complete Wilderness Survival Manual, Hugh McManners, 1994

Figure 15-12-5 Pitcher Plant



Camping and Wilderness Survival, Paul Taurell, 1996

Figure 15-12-6 Cactus

Solar Still

Water can be extracted from soil using a solar still. As long as there is a difference in temperature in between two surfaces, air between those surfaces will heat-up and become saturated and the air will condense as droplets on the cooler surface.

To construct a solar still, dig a hole about three feet wide and two feet deep. Place a collecting can at the bottom of the hole. Spread a plastic sheet across the hole and hold it in place with rocks. Weigh down the centre of the sheet over the container with a fist-sized rock. As the temperature of the air and soil rise, water vapour will condense on the underside of the cooler sheet and run into the container. Dig another hole when the moisture in the hole/still has been used up.



The Complete Wilderness Survival Manual, Hugh McManners, 1994

Figure 15-12-7 Solar Still

Digging for Water

Water will often seep into a hole dug in a location where the water table is high. Dig a hole about one foot deep. Water will seep from the ground into the hole. The water will be dirty the first few times the hole fills, but clear water will eventually rise and can be purified and drunk. Keep scooping away the muddy water until clear water rises. Note the surroundings before a water hole is dug. Never dig where the mud has a potent smell or a green slime on the surface. This water is probably contaminated. Do not collect water where there are dead animals and always purify the water before drinking.

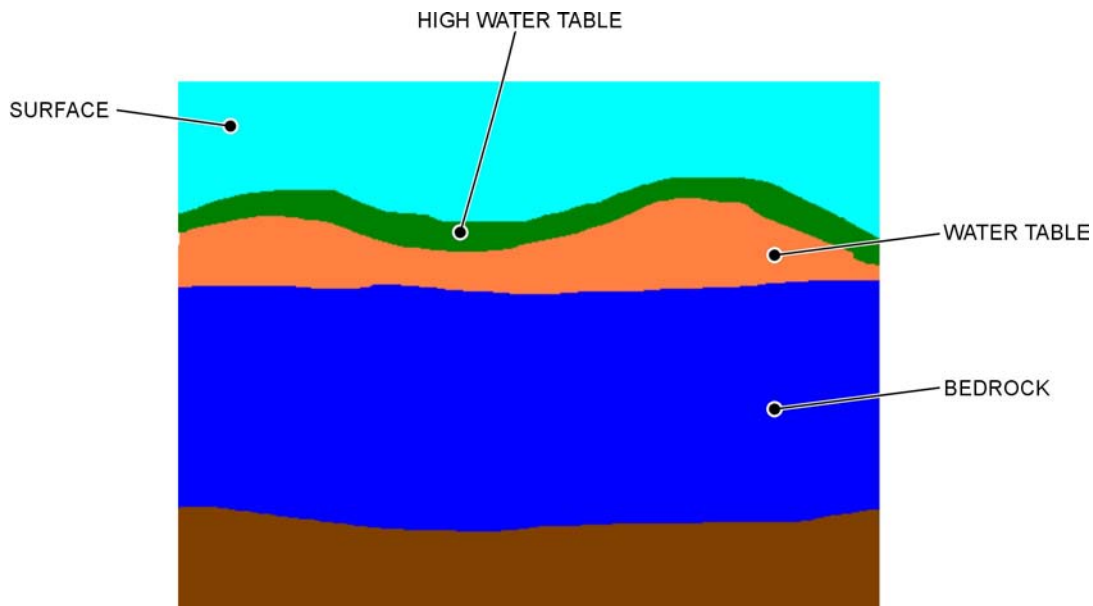

Microsoft Paint, 2006

Figure 15-12-8 Water Table

ACTIVITY

Time: 20 min

OBJECTIVE

Allow cadets to practice making a water collection devise.

RESOURCES

- Plastic bags/sheets of plastic (one per group).
- Shovels (one per group).
- Pegs.
- Cup or bowl.

ACTIVITY LAYOUT

- Instruct cadets to find an appropriate site and build one of the water collection devises listed above.
- Some or all of the provided resources may be used.
- The collection devises may be left out overnight to see if they produce positive results.

SAFETY

N/A.

INSTRUCTOR GUIDELINES

- Ensure cadets select an appropriate site to build the water collection devise.
- Ensure that the site selected will not adversely effect the environment.
- If holes are dug, ensure they are filled in upon completion of the activity.
- Check each devise to ensure each step has been followed and it has been suitably constructed.

CONFIRMATION OF TEACHING POINT 2**QUESTIONS**

- Q1. What are some surface characteristics to look for when looking for a water source?
- Q2. How can insects help to find a water source?
- Q3. What is a method of collecting water?

ANTICIPATED ANSWERS

- A1. Follow dry riverbeds. The structure and composition of the rocks may result in a stream emerging. The riverbed may be followed to its source. There may be a trickle of water that remains or humid soil is present where a pit can be dug to the water table. Watch for damp spots on the ground. A high water table can cause this. Old human habitations can be a good place to find water. Old mines and dumps are good examples. Water may be collected from dew accumulation.
- A2. Insects live within flying distance of water. Their flight path may be followed to a water source.
- A3. Rain collection, dew collection, water from vegetation, solar still, and water from the ground.

END OF LESSON CONFIRMATION

Each group's water collection devise shall be checked to ensure all of the principles of construction have been applied. Other lesson material can be confirmed by verbal questioning.

CONCLUSION**HOMEWORK/READING/PRACTICE**

N/A.

METHOD OF EVALUATION

There is no formal assessment of this EO.

CLOSING STATEMENT

Cadets have learned the effects of water on the human body, how to find water and how to collect it. Water is vital to human survival; without sufficient drinking water the body will shut down and eventually die. Having sufficient drinking water combats thirst, which can be an enemy of survival.

INSTRUCTOR NOTES/REMARKS

N/A.

REFERENCES

- C3-002 (ISBN 0-00-653140-7) Wiseman, J. (1986). *The SAS Survival Handbook*. London: Harper Collins Publishers.
- C3-003 (ISBN 1-896713-00-9) Tawell, P. (1996). *Camping and Wilderness Survival: The Ultimate Outdoors Book*. Green Valley, ON: Fifteenth Printing.
- C3-021 (ISBN 0-7715-9035-0) McManners, H. (1994). *The Complete Wilderness Survival Manual*. BC: McMillan Canada.

SURVIVAL SCENARIO

You are on a camping trip with your family. It is a pleasant day in mid-October. The campsite is far from town, and your family is the only one there. At 3 p.m., you decide to go on a short hike. You start off along a clearly marked trail. When you see a rabbit, you follow it off into the woods. When the rabbit finally goes down a hole, you realize you are lost. You don't know in which direction the trail or the campsite are. You have been gone from the campsite for about two hours. You are lost in the woods.

In your backpack, you have:

- a one litre bottle of water
- a sandwich bag of trail mix
- a bird identification book

You are wearing jeans, a T-shirt and a light jacket. The wind is picking up, and it looks like rain.

QUESTIONS

1. What is the first thing you should do?
2. Think about the consequences of staying where you are, or wandering through the woods. What are the pros and cons of each?
3. What kind of things would you want to observe about your surroundings?
4. Consider the key elements of the survival pattern – food, water, shelter, fire, and first aid. What is your plan?

THIS PAGE INTENTIONALLY LEFT BLANK

SUGGESTED ANSWERS FOR SURVIVAL SCENARIO – INSTRUCTOR USE ONLY

1. What is the first thing you should do? STOP.
2. Think about the consequences of staying where you are, or wandering through the woods. What are the pros and cons of each?

Staying		Walking	
Pros	Cons	Pros	Cons
<p>Effective use of time to develop and implement effective survival pattern.</p> <p>Staying in one place makes you easier to find.</p> <p>Prevents you from going farther away from potential search parties.</p> <p>Familiar with the nearby surroundings.</p>	<p>There may be hazards with the current location.</p> <p>There may be little or no resources at the current location.</p> <p>There is no chance of finding your way to civilization if you do not leave.</p> <p>Boredom could develop.</p>	<p>Could find your way to civilization – if you know the direction to travel.</p> <p>Could find better site for setting up shelter and signals.</p>	<p>Get more lost.</p> <p>Move away from a location where people can find you.</p> <p>End up unprepared for nightfall.</p> <p>Wasting energy.</p> <p>Increase risk of injury.</p> <p>Inadequate clothing or shoes.</p>

3. What kind of things would you want to observe about your surroundings?
 - Physical dangers.
 - Flooding hazards.
 - Food and water sources.
 - Location for shelter.
 - Signs to help determine location.
 - Evidence of animals.
 - Fire resources.
 - Shelter resources.
4. What is your plan?
 - First aid – there are no injuries, so this is not a concern.
 - Build a fire – this is good for signalling and warmth in the short term.
 - Build a shelter – stay dry in case it rains.
 - Signals – if there is an open area, lay ground-to-air signals. Build additional signal fires.
 - Water – stay hydrated. Find additional water sources before the litre runs out.
 - Food – ration the trail mix. Find additional sources of food.

THIS PAGE INTENTIONALLY LEFT BLANK

SHELTERS SET-UP

ERECT AN A-FRAME SHELTER

1. Select a level area with good drainage.
2. Ensure the area is free of hazards, (i.e., overhanging branches that may fall, too close to roadways etc).
3. Zip two shelter halves together, ensuring flap covers zipper.
4. Attach cord to the grommets at both ends near the joined zipper.
5. Suspend both ends from trees or other objects so that the centre is approximately waist high.
6. Stretch out the sides and secure them using sticks.
7. Attach cord to the middle grommets on each side and tie the cord to pull the side out and give more room to the inside.
8. When possible, dig a drainage trench on both sides.

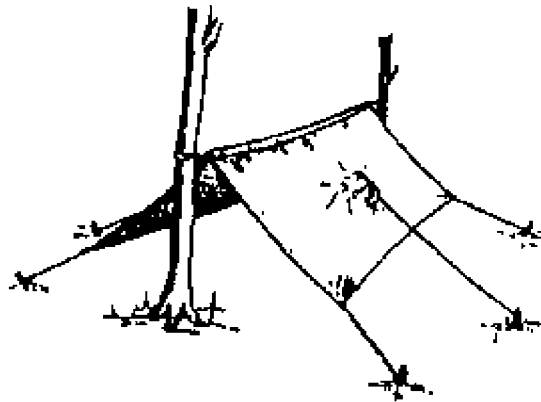

Figure 15C-1 A-frame Shelter

LEAN-TO SHELTER

1. To build a lean-to, two trees must be found with fairly firm, level ground between them. These trees are called the uprights. The distance between these two trees will be the opening of the lean-to.
2. Next, a ridgepole must be found. This must be a fairly thick pole, around fist size in thickness, and should be long enough to reach from one upright to the next.
3. The ridgepole should be placed behind the uprights from the viewpoint of the person facing the uprights. Natural notches in the uprights may be perfect to hold the ridgepole. If these are not available, the ridgepole will be laced onto the uprights using the square lashing. (It may be a good idea to lash the ridgepole on even when using natural notches to ensure the pole is secure). After the square lashing is completed, the ridgepole should be very secure. In fact, the people who will be using the shelter should be able to sit on it and it should not move.
4. The height of the ridgepole should be the height of the waist of the tallest person if a group will be staying in the shelter. This will make the shelter opening fairly low, which will help conserve heat inside the shelter. For a one-person lean-to, the ridgepole should be placed lower, at mid-thigh height.

5. Find approximately 8 poles about 5 to 7 cm in diameter. These will serve as the pole framework for the lean-to and will be known as the spars. They will be tied onto the ridgepole using the square lashing, and will run from the ridgepole to the ground. Spread these evenly, going from just inside one upright to the other.
6. The number and the height of the people living in the lean-to will determine the length of the spars. For a group, the spars should be slightly longer than the height of the tallest person. If the shelter will sleep one person, the spars should be about the same height as the chest of that person.
7. Find approximately 8 small flexible poles that will run horizontally across the spars. These will be known as the ribs. The length of these should be the distance between the two spars closest to the uprights. These ribs should be woven horizontally through the spars. If long enough ribs cannot be found, shorter ones can be used. Weave the shorter ribs as far as possible and then start at the point ended with a new piece.
8. A pole around the same thickness as the ridgepole should be found and laid on top of the bottom of the spars. This is known as the foot log.
9. Vertical poles will be placed from the ground to the spars on the furthest sides of the lean-to. These do not need to be laced onto the spars. They should be tall enough to reach from the ground to the spar, and since the spar is on a slope, the vertical poles will need to be of varying heights.
10. Place boughs with the stem toward the ridgepole and the top of the bough upwards (the glossy side).
11. Make a row going right across the bottom with the boughs close together.
12. For the next layer, lay the boughs into the first layer; again with the top of the bough facing up.
13. Repeat Step 12. until the top is reached and the boughs cover the lean-to like shingles cover a roof.
14. Weave the stems of more boughs into the layers that now cover the lean-to. These layers should be thick enough to be waterproof; a suggestion is around 15 cm thick.
15. For the sides of the lean-to, boughs can be placed as in the Steps above until the ground is reached.
16. If a fire has been made, extend boughs about a foot down the front of the lean-to to keep out rain or wind, but allow the heat from the fire to enter.
17. As described above, boughs can also be used to cover a part of the front if there is no fire. Just leave an opening for a door in case a quick exit is required.

COMMERCIAL TENTS

Commercial shelters come in various sizes and forms, and therefore, have different ways to be erected. Users should read the information booklets provided with the tent used in order to know how to erect it.

ARCTIC TENT ASSEMBLY AND PITCHING

1. Lay out the outer tent, flat apex in the centre and panels outwards with the inside facing upwards, and the door zipper fastened.
2. Lay out the inner tent liner on top of the outer tent, with the inside facing upwards.
3. Attach the top and bottom stovepipe toggles. By lining up the stovepipe openings of the outer and inner liner and attaching the top and bottom toggles, the inner and outer portions are then positioned properly.
4. Working either way, attach the remaining toggles. Use the corners of the tent as checkpoints to make sure no toggle was missed. Continue until all toggles are through the seam grommets of the inner liner.
5. Thread the long or the lower drying line through the drying line keepers. To get the drying line keepers through the inner seam splits, feel through the liner at the peak or centre of the doorway, follow-up the

seam on the panel of the outer tent, when you reach the drying line keeper, insert it through the split seam of the liner and thread the drying line on. There is a keeper on every seam. This means there are 10 keepers for the lower drying lines.

6. Thread on the short or upper drying line. Start at the door seam again and carry out the same drill as for the lower drying line. There will be a keeper on each side of this one and then one on every second seam. This means that there will be six drying line keepers on the top.
7. Insert the spike of the tent pole through the apex of the inner and outer tents and lash these three securely.
8. Attach the five bottom tie-down pegs. To do this, run a rope through the bottom wall eyelets of the outer and inner tents, tying the pegs to the outside.
9. Attach the wall guy lines to the guy line loops on the outer tents. To do this, thread the guy lines through one hole of the runner then through the guy line loop of the tent and back through the outer hole of the runner. Tie a figure-of-eight knot on this end of the guy line to prevent it from slipping out of the runner hole. The other end of the guy line is threaded through the eye of the peg of the line and is prevented from being pulled out of the peg by a slipknot. This method of attaching guy lines must be used as the rope will invariably freeze in the peg hole and to reverse the above procedure will prevent tightening of guy lines. In addition, when the ground is too hard, or snow too soft and deep, the pegs can be secured by wrapping several turns of the guy line to the centre of the peg and either freeze the peg in the snow or place a large stone or log on top of the peg.
10. Attach the five top guy lines in the same manner.
11. The tent is now assembled and ready for use; however, when the tent is pitched and the doors are opened, quite often the zippers become disengaged. To prevent this, close the zipper and, sew the track of the zipper together near the top of the door. This will act as a stopper, preventing the zipper from becoming disengaged. Do this to the outer and the inner tent zippers.
12. The fly screen is of no use in cold weather and should be rolled up and secured by the ties running each way from the door to the outside corners. Roll and secure this screen, only after the tent has been pitched. If done when the tent is struck, the tent will be misshapen when pitched.
13. To prevent the guy lines from being left hanging loose and becoming tangled, roll the guy rope around the tent peg and in the guy rope loop. In most cases the guy rope loops are sewn too far down and the loop is not large enough for the peg to fit in. To overcome this, thread short pieces of the rope through the guy line loops and tie with a square knot. Adjust the knot so the peg will fit securely in it.

STRIKING AN ARCTIC TENT

1. Members take positions. One person is inside at the tent pole. Three people are at the guy ropes located above the left side tie-down point, above the right side tie-down point, and above the back tie-down point. One person is supervising the procedure and giving orders.
2. The order "pull pole" is given.
3. The person inside the tent pulls the bottom of the pole towards the door and lowers the tip to the rear of the tent. That person disconnects the lower section or telescopes the pole, depending on which pole is being used.
4. The member at the back guy rope grasps the apex of the tent.
5. The person at the pole backs out of the door, carrying the pole sections and base plate, and zippers the door closed.
6. The two persons at the right and left side guy ropes roll up the guys and secure them to the tent. They pull out the remaining pegs, roll up the guys and secure them to the tent.

7. The members pull the tent to the rear and spread it out on the ground.
8. The order "shake out" is given. Members spread around the tent, shake the snow/ice/sand/etc. out and fold the tent for stowing.

FOLDING AN ARCTIC TENT FOR STORAGE

1. Lay out the tent with the tent door up, in the centre and with zippers closed.
2. Make sure there are no double folds on the underside.
3. Hold the apex securely: the first long fold is made by folding the wings to the centre, with the pegs straight up and down.
4. Straighten and flatten out.
5. Fold-in snow flaps across the base.
6. Make the second long fold, repeating the action as with the first long fold.
7. Straighten and flatten out.
8. Make the third long fold.
9. Straighten and flatten out.
10. Fourth long fold – flip folds one on top of the other.
11. Make the first cross fold: fold in base at the top of wall.
12. Make the second cross fold by folding the apex into the base of the inserted pole section allowing approximately 4 inches of loose fold at the base of the pole section to avoid wear and tear: top of pole should be offset.
13. Third cross fold – place the folds one on top of the other.
14. Insert in the bag (base plate and spare pegs have already been placed in the bag).
15. Place the remaining two pole sections in the bag alongside the tent.
16. Tie-up the top of the tent bag.

PITCHING AND ANCHORING A MODULAR TENT

The key stages for pitching and anchoring a modular tent are as follows:

1. Lay the frame parts on the ground and erect the arch frames (A-frames), leaving the uprights folded and placed at equal distances one from the other.

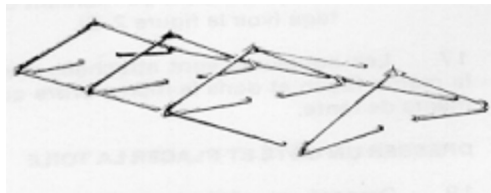

Figure 15C-2 A-frames

2. Join the tie beams (purloins) to each of the arches at the summit and roof edges, locking them into place.

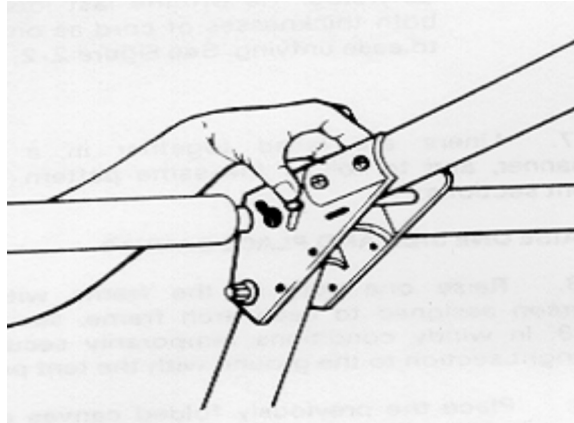

Figure 15C-3 Joining of the Tie Beams

3. Generally using one person per arch, raise one side of the frame.

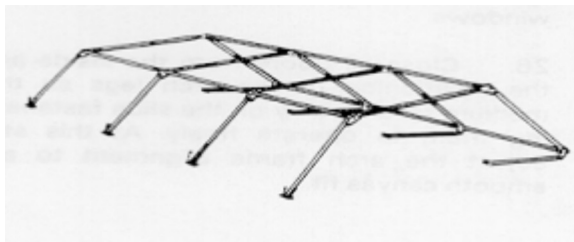

Figure 15C-4 Raising One Side

4. Before lacing the tent canvas together, close all doors. Lace the tent canvas together, placing them on the frame and attaching them at the top of the arches.

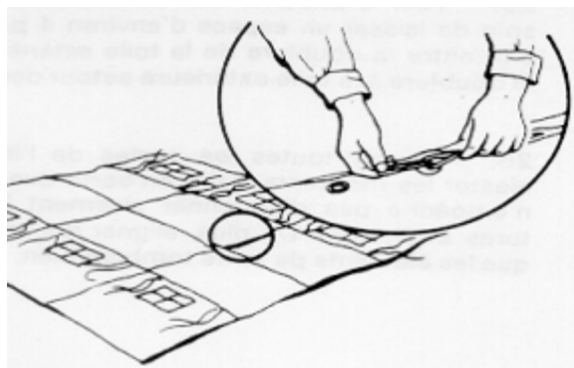

Figure 15C-5 Lacing the Tent Canvas



Figure 15C-6 Half of the Tent Is Laced

5. Raise the other side of the frame.
6. Attach the stays without tensioning them and lace the rest of the canvas.
7. Using straps, attach the canvas and lining to the ties on the edges of the roof.
8. Align the arches and adjust the canvas.
9. Raise the tent completely.
10. Drive pickets in each foot from the outside.
11. Tension the stays.
12. Attach the ground canvas using sandbags or earth.
13. Dig drainage trenches as required.

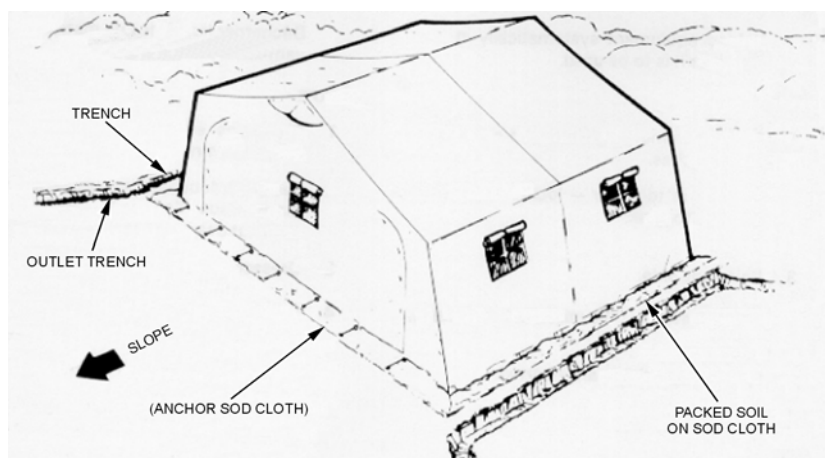

Figure 15C-7 Modular Tent

STRIKING A MODULAR TENT

1. Release cables and anchors and remove them if the wind is not too strong. Otherwise, leave them in place until the tent has been disassembled.
2. Remove earth or sandbags covering the ground sheet.
3. Undo adjusting stays from the edge of the roof.
4. Unlace the sides of the tent and lower one side.
5. Remove the lining strapped to the frame, and fold it.

6. Lower the other side of the tent, unlace tent parts, remove them from the frame and fold them.
7. Disassemble the frame and pack the components.
8. Take necessary steps to clean and dry components as required, with the shortest possible delay.

Folding the Centre Canvas

1. After having removed the canvas from the frame, close the windows and doors.
2. Stretch the canvas inside a building on the floor, on a dry and clean surface.
3. Clean the canvas and ground sheet using a broom.
4. Fold the ground sheet towards the centre.
5. Fold the canvas on its length towards the centre of the sheet, until the canvas is long and narrow.
6. Fold the canvas in the other direction towards the centre.

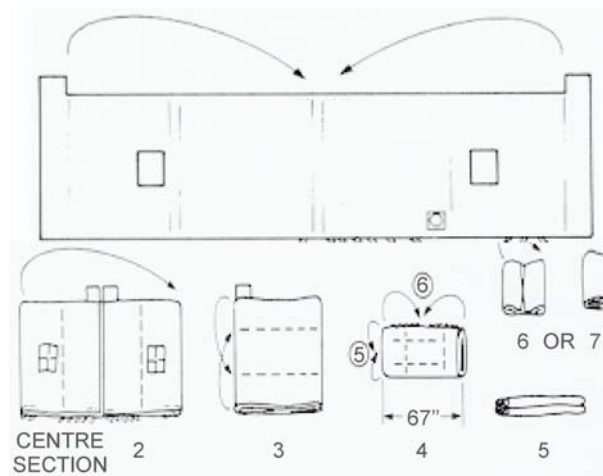

Figure 15C-8 Folding of the Centre Section

Folding the Outside Walls (Doors)

1. As for the central canvas, clean the canvas and fold the ground sheet towards the inside.
2. Fold the point towards the inside part.
3. Fold the canvas towards the centre and secure it.

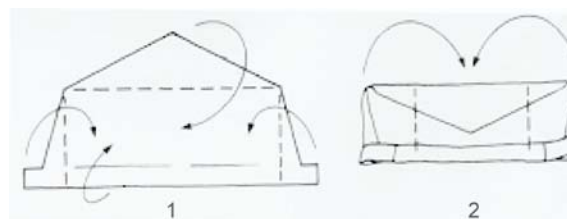

Figure 15C-9 Folding the Outside Walls

THIS PAGE INTENTIONALLY LEFT BLANK

RECOGNIZE ENVIRONMENTAL INJURIES ACTIVITY

<p>I am a sign to the body that one's boots do not fit.</p> <p>What am I?</p>	<p>To make me feel better one should relieve the pressure on the area by loosening the boots.</p> <p>What am I?</p>	<p>One will get me if they walk without extending their ankle on each step.</p> <p>What am I?</p>	<p>Some possible causes of me include lack of water, lack of calcium and lack of sodium.</p> <p>What am I?</p>
<p>When I occur one should wrap a heavy bandage on me and let me rest in an elevated position.</p> <p>What am I?</p>	<p>I am initial pain to the cold.</p> <p>What am I?</p>	<p>My affected area will be white and frozen to the touch.</p> <p>What am I?</p>	<p>Blisters usually form when I occur.</p> <p>What am I?</p>
<p>I mean too little heat.</p> <p>What am I?</p>	<p>To help prevent me one should seek protection from the wind, keep dry and ensure proper nutrition and hydration.</p> <p>What am I?</p>	<p>When I affect others I make them stumble, slur their speech, make bad judgements and complain of coldness.</p> <p>What am I?</p>	<p>My symptoms include shallow breathing, vomiting and dizziness.</p> <p>What am I?</p>

<p>Treatment for me includes moving to the shade, resting and drinking water with a little salt in it.</p> <p>What am I?</p>	<p>My symptoms include a pale face, a weak pulse, cold yet sweating skin and cramps.</p> <p>What am I?</p>	<p>My symptoms include hot dry skin, rising temperature, fast strong pulse and a severe headache.</p> <p>What am I?</p>	<p>Treatment for me includes laying in the shade with ones head and shoulders raised, removing layers of outer clothing and cooling the body with tepid water.</p> <p>What am I?</p>
<p>Treatment for me includes avoiding further exposure to the sun, taking painkillers and covering blisters with dressings.</p> <p>What am I?</p>	<p>Treatment for me includes resting in the shade, covering eyes after washing out debris and bathing eyes in warm water.</p> <p>What am I?</p>	<p>My symptoms include dizziness, headache, laboured breathing, lack of salivation, indistinct speech and the inability to walk.</p> <p>What am I?</p>	

ANSWER KEY – RECOGNIZE ENVIRONMENTAL INJURIES ACTIVITY

<p>I am a sign to the body that one's boots do not fit.</p> <p>Answer: Blister</p>	<p>To make me feel better one should relieve the pressure on the area by loosening the boots.</p> <p>Answer: Blister</p>	<p>One will get me if they walk without extending their ankle on each step.</p> <p>Answer: Shin Splints</p>	<p>Some possible causes of me include lack of water, lack of calcium and lack of sodium.</p> <p>Answer: Muscle Cramps</p>
<p>When I occur one should wrap a heavy bandage on me and let me rest in an elevated position.</p> <p>Answer: Sprain</p>	<p>I am initial pain to the cold.</p> <p>Answer: Frostnip</p>	<p>My affected area will be white and frozen to the touch.</p> <p>Answer: Superficial Frostbite</p>	<p>Blisters usually form when I occur.</p> <p>Answer: Deep Frostbite</p>
<p>I mean too little heat.</p> <p>Answer: Hypothermia</p>	<p>To help prevent me one should seek protection from the wind, keep dry and ensure proper nutrition and hydration.</p> <p>Answer: Hypothermia</p>	<p>When I affect others I make them stumble, slur their speech, make bad judgements and complain of coldness.</p> <p>Answer: Hypothermia</p>	<p>My symptoms include shallow breathing, vomiting and dizziness.</p> <p>Answer: Heat Cramps</p>

<p>Treatment for me includes moving to the shade, resting and drinking water with a little salt in it.</p> <p>Answer: Heat Cramps</p>	<p>My symptoms include a pale face, a weak pulse, cold yet sweating skin and cramps.</p> <p>Answer: Heat Exhaustion</p>	<p>My symptoms include hot dry skin, rising temperature, fast strong pulse and a severe headache.</p> <p>Answer: Heatstroke</p>	<p>Treatment for me includes laying in the shade with ones head and shoulders raised, removing layers of outer clothing and cooling the body with tepid water.</p> <p>Answer: Heatstroke</p>
<p>Treatment for me includes avoiding further exposure to the sun, taking painkillers and covering blisters with dressings.</p> <p>Answer: Sunburn</p>	<p>Treatment for me includes resting in the shade, covering eyes after washing out debris and bathing eyes in warm water.</p> <p>Answer: Sore Eyes</p>	<p>My symptoms include dizziness, headache, laboured breathing, lack of salivation, indistinct speech and the inability to walk.</p> <p>Answer: Dehydration</p>	